

# SHOT

BOT LIGHTING

catalogo  
**SORGENTI E  
APPARECCHI**

2026-27

# SHOT

BOT LIGHTING



**LA LUCE DEL DOMANI**  
*THE LIGHT OF TOMORROW*

Bot Lighting da oltre 40 anni illumina gli spazi di tutti con soluzioni innovative e di alta qualità.

Grazie a una rete capillare di 40 agenzie e 2.000 distributori in Italia, rispondiamo in modo rapido e affidabile alle esigenze dei nostri clienti.

Crediamo nell'innovazione, nel design raffinato e nella sostenibilità, guidati da una logistica efficiente e da relazioni solide costruite su professionalità e dinamismo.

La nostra missione è rendere l'illuminazione evoluta accessibile a tutti, utilizzando le migliori tecnologie per offrire efficienza, design e rispetto per l'ambiente.

Con la nostra cultura della luce, vogliamo trasformare ogni spazio elevando la qualità della vita.

*For over 40 years, Bot Lighting has illuminated spaces with innovative, high-quality solutions.*

*Thanks to a network of 40 agencies and 2,000 distributors across Italy, we respond to customer needs quickly and reliably.*

*We believe in innovation, design, and sustainability, supported by efficient logistics and strong professional relationships.*

*Our mission is to make advanced lighting accessible to everyone, offering efficiency, style, and respect for the environment.*

*Through our culture of light, we transform every space and help improve quality of life.*



#### **40 AGENZIE IN ITALIA**

Oltre 2.000 clienti attivi nei settori elettrico, ferramenta, illuminazione, fai da te e grande distribuzione specializzata.

#### **40 AGENCIES ACROSS ITALY**

Over 2,000 active customers in the electrical, hardware, lighting, DIY, and large-scale retail sectors.



#### **RICERCA E SVILUPPO**

Disponiamo di un laboratorio tecnico interno per il costante controllo della qualità.

#### **RESEARCH AND DEVELOPMENT**

We have an in-house technical laboratory for constant quality control.



#### **PRESENZA INTERNAZIONALE**

Siamo presenti in Europa con distributori e agenzie in Francia, Germania, Spagna, Slovenia, Malta e Grecia.

#### **INTERNATIONAL PRESENCE**

We operates across Europe through distributors and agencies in France, Germany, Spain, Slovenia, Malta, and Greece.



#### **SEDI OPERATIVE**

- Cazzago di Pianiga (Venezia): sede logistica e commerciale di 3000 mq.
- Padova: sede logistica in outsourcing di 2000 mq.
- Quarto d'Altino (Venezia): sede logistica in outsourcing di 1500 mq.

#### **OPERATIONAL SITES:**

- Cazzago di Pianiga (Venice): 3,000 sqm logistics and commercial headquarters.
- Padua: 2,000 sqm outsourced logistics site.
- Quarto d'Altino (Venice): 1,500 sqm outsourced logistics site.

# LA NOSTRA STORIA

## OUR STORY

Da oltre 40 anni trasformiamo la luce in espressione e innovazione, unendo passione, sostenibilità e ricerca.

Forti della nostra esperienza, guardiamo al futuro per creare nuove visioni di luce.

*For over 40 years, we have transformed light into expression and innovation, combining passion, sustainability, and research.*

*Building on our experience, we look to the future to create new visions of light.*



### 1921

**NELLA VETRERIA DI AIRAM NASCONO LE PRIME SORGENTI LUMINOSE, FATTE A MANO IN VETRO SOFFIATO**

IN AIRAM GLASSWORKS THE FIRST LIGHT SOURCES WERE CREATED, MADE BY HAND AND THROUGH THE ART OF GLASSBLOWING.



### 1970

**GIANNI BOT IMPORTA LE LUCI AIRAM E LE PROPONE CON SUCCESSO NEL MERCATO ITALIANO**

GIANNI BOT IMPORTS AIRAM LIGHTS AND SUCCESSFULLY PROPOSES THEM IN THE ITALIAN MARKET.



### 2005

**BOT LIGHTING ENTRA NEL MERCATO DELLE SORGENTI LED**

BOT LIGHTING ENTERS THE LED LIGHT SOURCE MARKET



### 2015

**SPECIALISTI NELLA PRODUZIONE DI LAMPADE DECORATIVE CON TECNOLOGIA LED**

SPECIALISTS IN THE PRODUCTION OF DECORATIVE LAMPS WITH LED TECHNOLOGY

# SHOT

BOT LIGHTING



GUARDA IL VIDEO DELLA NOSTRA STORIA

WATCH THE VIDEO OF OUR STORY



1982

VALLI MENEGALDO FONDA L'AZIENDA BOT LIGHTING SRL

VALLI MENEGALDO FOUNDS THE COMPANY BOT LIGHTING SRL



1990

INIZIANO LE PRIME RELAZIONI E FORNITURE INTERNAZIONALI CON IL FAR EAST

THE FIRST INTERNATIONAL RELATIONS AND TRADE DEALS ARE ESTABLISHED WITH THE FAR EAST



2000

LEADERSHIP NELLA VENDITA E NELLA COMMERCIALIZZAZIONE DELLE LAMPADRE CFL

LEADERSHIP ROLE IN THE SALE AND MARKETING OF CFL LAMPS



2020

EVOLUZIONE TECNOLOGICA CON LE LINEE SMART HOME

TECHNOLOGICAL EVOLUTION WITH SMART HOME LINES

40<sup>TH</sup> ANNIVERSARY  
1982-2022

2022

CELEBRAZIONE DEL 40° ANNIVERSARIO DALLA FONDAZIONE

CELEBRATION OF 40TH ANNIVERSARY SINCE FOUNDING



2026

IMPEGNO NELLO SVILUPPO DI LAMPADRE SEMPRE PIÙ EFFICIENTI, DI DESIGN ED ECOSOSTENIBILI

COMMITMENT TO DEVELOPING LAMPS THAT ARE EVER MORE EFFICIENT, STYLISH, AND ENVIRONMENTALLY SUSTAINABLE

# DA OLTRE 40 ANNI, LEADER PER ESPERIENZA E VISIONE FOR OVER 40 YEARS, A LEADER THROUGH EXPERIENCE AND VISION

Da sempre puntiamo all'eccellenza, unendo innovazione, esperienza e passione in ogni progetto.

La nostra forza nasce da ricerca continua, dalla cura dei dettagli e da una visione orientata al futuro. Ogni fase, dalla progettazione alla produzione, è seguita con precisione e professionalità per offrire soluzioni all'avanguardia e garantire qualità, affidabilità e servizio su misura.

Affidati a chi da oltre quarant'anni fa della luce la propria missione

*Since the very beginning, we have aimed for excellence, combining innovation, experience, and passion in every project.*

*Our strength comes from continuous research, attention to detail, and a forward-looking vision. Every stage, from design to production, is managed with precision and professionalism to deliver cutting-edge solutions and ensure quality, reliability, and tailored service.*

*Trust a company that has made light its mission for over 40 years.*



# I NOSTRI FOCUS

## OUR KEY POINTS



### **Progettazione illuminotecnica**

Progetti personalizzati per illuminare al meglio ogni ambiente.

### **Lighting Design**

*Custom projects to optimally illuminate every environment.*



### **Dipartimento R&D**

Innovazione costante e sviluppo di nuove soluzioni.

### **R&D Department**

*Constant innovation and development of new solutions.*



### **Servizio, assistenza e garanzia**

Supporto qualificato in ogni fase.

### **Service, Support and Warranty**

*Qualified support at every stage.*



### **Controllo qualità**

Nella nostra sede con verifiche approfondite dal prototipo alla produzione.

### **Quality Control**

*In our headquarter through inspections from prototype to production.*



### **Packaging e interazione con la produzione**

Cura e attenzione in ogni dettaglio.

### **Packaging and Production integration**

*Care and attention to every detail.*



### **Marketing e attività digital**

Comunicazione e presentazione efficace dei prodotti. Presenza online aggiornata con nuove strategie digitali.

### **Marketing and Digital Activities**

*Effective product communication and presentation. Updated online presence and digital strategies.*

# SOSTENIBILITA' E VALORE PER L'AMBIENTE

## SUSTAINABILITY AND ENVIRONMENTAL VALUE

Bot Lighting è da sempre attenta al risparmio energetico e alla sostenibilità, scegliendo le migliori tecnologie LED e processi produttivi a basso impatto ambientale.

Oggi i nostri prodotti offrono ancora più valore grazie a un design curato in ogni dettaglio e all'utilizzo sempre più diffuso di materiali riciclati ed ecosostenibili.

Da sempre, lavoriamo per un futuro più luminoso e sostenibile.

*Bot Lighting has always been committed to energy saving and sustainability, selecting the best LED technologies and low environmental impact production processes.*

*Today, our products offer even greater value thanks to carefully refined design in every detail and the increasingly widespread use of recycled and eco-sustainable materials.*

*We have always worked toward a brighter and more sustainable future.*





### **ECOSOSTENIBILITÀ PRODOTTI**

Prodotti innovativi ed efficienti. Gamma solare in espansione, LED sempre più performanti e tecnologie IoT per un controllo intelligente della luce.

### **ECO-SUSTAINABILITY PRODUCTS**

*Expanding solar range, increasingly high-performance LEDs and IoT technologies for intelligent light control*



### **PACKAGING SOSTENIBILE**

Riduzione e sostituzione della plastica con materiali riciclati e riciclabili, nuove scatole e pallets eco-friendly, ed etichettatura ambientale aggiornata.

### **SUSTAINABLE PACKAGING**

*Reduction and replacement of plastic with recycled and recyclable materials, new eco-friendly boxes and pallets, and updated environmental labeling.*



### **UFFICI E SEDE**

Sede con illuminazione regolabile, gestione efficiente dell'energia, riduzione della plastica e smart working per un impatto ambientale sempre più basso.

### **OFFICES AND HEADQUARTERS**

*Headquarters featuring adjustable lighting, efficient energy management, plastic reduction and smart working for an increasingly lower environmental impact.*

**SHOT**  
BOT LIGHTING

# INDICE / INDEX

## LAMPADINE / LIGHT BULBS

### IOT / SMART

GOCCIA STICK SMART A60 TUNABLE WHITE	P. 37
GOCCIA OPALE SMART RGB + TUNABLE WHITE	P. 38
SFERA OPALE SMART RGB + TUNABLE WHITE	P. 38
OLIVA OPALE SMART RGB + TUNABLE WHITE	P. 38
GLOBO 95 OPALE SMART RGB + TUNABLE WHITE	P. 39
REFLECTOR R80 OPALE SMART RGB + TUNABLE WHITE	P. 39
GU10 SMART RGB + TUNABLE WHITE	P. 39

### CLASSE A / A CLASS

GOCCIA LED STICK H	P. 42
SFERA LED STICK H	P. 42
OLIVA LED STICK H	P. 43
GLOBO 125 LED STICK H	P. 43

### FILAMENTO BIANCO / WHITE FILAMENT

GOCCIA WHITE FILAMENT	P. 45
SFERA WHITE FILAMENT	P. 45
OLIVA WHITE FILAMENT	P. 46
GLOBO WHITE FILAMENT	P. 46

### LED STICK

GOCCIA LED STICK CRI >95	P. 49
SFERA LED STICK CRI>95	P. 49
OLIVA LED STICK CRI>95	P. 49
GOCCIA LED STICK DIMMERABILE	P. 50
SFERA LED STICK DIMMERABILE	P. 50
OLIVA LED STICK DIMMERABILE	P. 51
OLIVA LED STICK SATINATA DIMMERABILE	P. 51
GLOBO 125 LED STICK DIMMERABILE	P. 52
GLOBO 125 LED SPRING DIMMERABILE	P. 52
TUBOLARE T38 LED STICK DIMMERABILE	P. 52
GOCCIA LED STICK	P. 53
SFERA LED STICK	P. 54
OLIVA LED STICK	P. 55
TORTIGLIONE LED STICK	P. 55
FIAMMA LED STICK	P. 56
GLOBO 95 LED STICK	P. 57
GLOBO 125 LED STICK	P. 57
PICCOLA PERA LED STICK	P. 58
TUBOLARE T20 LED STICK	P. 58
TUBOLARE T25 LED STICK	P. 59

TUBOLARE T32 LED STICK	P. 59
GOCCIA LED STICK SATINATA	P. 61
SFERA LED STICK SATINATA	P. 61
OLIVA LED STICK SATINATA	P. 62
TORTIGLIONE LED STICK SATINATA	P. 62
FIAMMA LED STICK SATINATA	P. 63
GLOBO 125 LED STICK SATINATA	P. 63
REFLECTOR R39 LED STICK SATINATA	P. 63
REFLECTOR R50 LED STICK SATINATA	P. 64
REFLECTOR R63 LED STICK SATINATA	P. 64
REFLECTOR R80 LED STICK SATINATA	P. 64
REFLECTOR R125 LED STICK SATINATA DIMMERABILE	P. 65
GOCCIA LED STICK CUPOLA ARGENTATA	P. 65
SFERA LED STICK CUPOLA ARGENTATA	P. 65
GOCCIA LED STICK CON SENSORE CREPUSCOLARE	P. 66

### FULL LIGHT

GOCCIA FULL LIGHT - Classe B	P. 68
GOCCIA FULL LIGHT	P. 68
SFERA FULL LIGHT	P. 69
OLIVA FULL LIGHT	P. 70
TORTIGLIONE FULL LIGHT	P. 70
FIAMMA FULL LIGHT	P. 70
GLOBO 95 FULL LIGHT	P. 71
GLOBO 125 FULL LIGHT	P. 71
GOCCIA FULL LIGHT DIMMERABILE	P. 72
SFERA FULL LIGHT DIMMERABILE	P. 72
OLIVA FULL LIGHT DIMMERABILE	P. 72
GLOBO 125 FULL LIGHT DIMMERABILE	P. 73
TUBOLARE T38 FULL LIGHT DIMMERABILE	P. 73

### VINTAGE

EDISON LED STICK GOLD	P. 76
GOCCIA LED STICK GOLD	P. 76
OLIVA LED STICK GOLD	P. 76
TORTIGLIONE LED STICK GOLD	P. 77
GLOBO 95 LED STICK GOLD	P. 77
GLOBO 125 LED STICK GOLD	P. 77
GOCCIA F.O.B. STICK DIMMERABILE	P. 78
GLOBO F.O.B. STICK DIMMERABILE	P. 78
BT F.O.B. STICK DIMMERABILE	P. 78
ALVEARE F.O.B. STICK DIMMERABILE	P. 79
UFO F.O.B. STICK DIMMERABILE	P. 79
LANTERNA F.O.B STICK DIMMERABILE	P. 79

### SMD

GOCCIA OPALE A60	P. 82
GOCCIA OPALE A67	P. 83
GOCCIA OPALE A80	P. 83
SFERA OPALE E27	P. 84
SFERA OPALE E14	P. 85
OLIVA OPALE	P. 86
GLOBO 95 OPALE	P. 87
GLOBO 120 OPALE	P. 87
GOCCIA OPALE DIMMERABILE	P. 88
SFERA OPALE DIMMERABILE	P. 88
OLIVA OPALE DIMMERABILE	P. 88
PICCOLA PERA PER FRIGORIFERI	P. 89
PICCOLA PERA	P. 89
PICCOLA PERA COLORATA	P. 90
PICCOLA PERA 24V DC	P. 90
TUBOLARE T37	P. 91
TUBOLARE T45	P. 91
REFLECTOR R39	P. 92
REFLECTOR R50	P. 92
REFLECTOR R63	P. 93
REFLECTOR R80	P. 93
LED GU10 H - 36°	P. 94
LED GU10 H - 100°	P. 94
LED GU10 HP - 36°	P. 95
LED GU10 HP - 100°	P. 95
LED GU10 - 36°	P. 96
LED GU10 - 60°	P. 96
LED GU10 - 110°	P. 97
LED GU10 HP - 100° - DIMMERABILE	P. 97
LED GU10 - DIMMERABILE	P. 97
LED GU10 ALL-GLASS H	P. 98
LED GU10 ALTA TEMPERATURA	P. 98
LED GU10 ALL-GLASS FASCIO STRETTO	P. 99
LED GU10 ALL-GLASS	P. 99
LED GU10 ALL-GLASS DIMMERABILE	P. 99
LED MR11	P. 100
LED MR16	P. 100
LED MR16 ALL-GLASS	P. 101
LED MR16 ALL-GLASS DIMMERABILE	P. 101
LED PAR30 WATERPROOF IP65 DIMMERABILE	P. 102
LED PAR38 WATERPROOF IP65 DIMMERABILE	P. 102
LED BISPINA G4	P. 103

LED BISPINA G4 SATINATA	P. 103
LED BISPINA G4 CHIARA	P. 103
LED G9 ALL-GLASS	P. 104
LED G9	P. 104
LED G9 DIMMERABILE	P. 105
LED G9 COB	P. 105
LED LINEARE R7S	P. 106
LED LINEARE R7S DIMMERABILE	P. 106
LED LINEARE R7S 78MM	P. 107
LED LINEARE R7S 2000LM DIMMERABILE	P. 107
LED LINEARE R7S 3000LM	P. 107
PL ALC LED	P. 108
PL AL LED	P. 108
PL ALL LED	P. 108
LED AR111 CRI>97 DIMMERABILE	P. 109
LED GX53	P. 109
LED LINEARLINE 300MM	P. 110
LED LINEARLINE 500MM	P. 110
LED LINEARLINE 1000MM	P. 110
LAMPADA ELLITTICA SMD HID	P. 111
LAMPADA ELLISSOIDALE ALTA POTENZA HID	P. 111
LAMPADA TUBOLARE ALTA POTENZA HID	P. 112

## SPECIALI / SPECIAL

GOCCIA OPALE CON SENSORE CREPUSCOLARE	P. 114
GOCCIA OPALE CON SENSORE DI MOVIMENTO E CREPUSCOLARE	P. 114
GOCCIA OPALE 12/24V AC/DC	P. 114
GOCCIA LED FROST PER CELLA FRIGORIFERA -40 °C	P. 115
GOCCIA LED ANTIZANZARE	P. 115
GOCCIA LED PER SAUNA +60 °C	P. 115
GOCCIA LED SURGE PROTECTION	P. 116
LED PLANT PAR20 PER CRESCITA PIANTE	P. 116
LED PLANT PAR30 PER CRESCITA PIANTE	P. 116
LAMPADE CCT	P. 117

## TUBI LED / LED TUBES

TUBO LED VETRO T8 A-CLASS	P. 118
TUBO LED VETRO T8 HIGH EFFICIENCY	P. 118
TUBO LED VETRO T8	P. 119
TUBO LED VETRO T8 SE	P. 120
TUBO LED VETRO T8 FOOD	P. 120
TUBO LED VETRO T5 - MAINS	P. 121
CIRCOLINE T9 LED	P. 121

STARTER PER TUBI T8 A LED	P. 121
---------------------------	--------

## SORGENTI TRADIZIONALI / TRADITIONAL LIGHT BULBS

### LAMPADE ALOGENE / HALOGEN LAMPS

LINEARE ENERGY SAVING R7S DIMMERABILE	P. 124
SPOT RAGGI INFRAROSSI	P. 124

### LAMPADE AD INCANDESCENZA / INCANDESCENT BULBS

PICCOLA PERA CHIARA	P. 125
PICCOLA PERA CHIARA PER FORNI 300 °C	P. 125

### SCARICA IODURI / IODIDE DISCHARGE

NACHROMA ELLISSOIDALE DIFFONDENTE	P. 126
NATRALOX SUPER TUBOLARE TRASPARENTE	P. 126

### LAMPADE UVC / UVC LAMPS

PL UVC	P. 128
TUBO T5 UVC	P. 129
TUBO T8 UVC	P. 129

## APPARECCHI TECNICO / TECHNICAL LIGHTING FIXTURES

### PLAFONIERE / CEILING LIGHTS

<b>IRIS ROUND</b> Plafoniera CCT / CCT ceiling light	P. 132
<b>IRIS SQUARED</b> Plafoniera CCT / CCT ceiling light	P. 133
<b>VAASA</b> Plafoniera CCT / CCT ceiling light	P. 134
<b>VAASA BIG</b> Plafoniera CCT / CCT ceiling light	P. 135
<b>JUPITER</b> Plafoniera PIR / PIR ceiling light	P. 136
<b>LINDA</b> Plafoniera CCT / CCT ceiling light	P. 138
<b>LINDA KIT SOSPENSIONE</b> Accessorio kit sospensione / Pendant kit accessory	P. 138
<b>COCO</b> Plafoniera / Ceiling light	P. 140
<b>RIO</b> Plafoniera / Ceiling light	P. 142
<b>RIO RADAR</b> Plafoniera con radar / Radar ceiling light	P. 143
<b>ERIKA ROUND</b> Plafoniera CCT / CCT ceiling light	P. 144
<b>ERIKA SQUARED</b> Plafoniera CCT / CCT ceiling light	P. 145
<b>NORA ROUND</b> Plafoniera CCT / CCT ceiling light	P. 146
<b>NORA SQUARED</b> Plafoniera CCT / CCT ceiling light	P. 148
<b>SONO III PIR</b> Plafoniera PIR / PIR ceiling light	P. 150
<b>GIADA II</b> Plafoniera multifunzione ad alta resistenza / High resistance multifunctional ceiling light	P. 152
<b>RONDA</b> Plafoniera CCT / CCT ceiling light	P. 154
<b>RONDA BIG</b> Plafoniera CCT / CCT ceiling light	P. 155
<b>SONJA</b> Plafoniera / Ceiling light	P. 156
<b>SONJA OVAL</b> Plafoniera / Ceiling light	P. 157
<b>OVIEDO ROUND</b> Plafoniera CCT / CCT ceiling light	P. 158
<b>OVIEDO OVAL</b> Plafoniera CCT / CCT ceiling light	P. 159
<b>BURGOS</b> Plafoniera CCT / CCT ceiling light	P. 160

### PANNELLI LED / LED PANELS

<b>PANNELLO LED BACKLIT 600X600 ALTA EFFICIENZA</b> 600X600 HIGH EFFICIENCY BACKLIT LED PANEL	P. 164
<b>PANNELLO LED BACKLIT 600X600 ALTA EMISSIONE</b> 600X600 HIGH EMISSION BACKLIT LED PANEL	P. 165
<b>PANNELLO LED BACKLIT 600X600</b> 600X600 BACKLIT LED PANEL	P. 166

<b>PANNELLO LED BACKLIT 600X600 - VALUE 4PACK</b> 600X600 BACKLIT LED PANEL - VALUE 4PACK	P. 167
---	--------

<b>PANNELLO LED BACKLIT 300X1200</b> 300X1200 BACKLIT LED PANEL	P. 168
--	--------

<b>PANNELLO LED EDGELIT 600X600</b> 600X600 EDGELIT LED PANEL	P. 169
--	--------

<b>PANNELLO LED EDGELIT 300X1200</b> 300X1200 EDGELIT LED PANEL	P. 170
--	--------

<b>DRIVER PER PANNELLI LED</b> DRIVER FOR LED PANELS	P. 172
---	--------

<b>KIT MONTAGGIO PANNELLI</b> PANELS MOUNTING KIT	P. 172
--	--------

<b>DRIVER MULTIFUNZIONE DALI 2/ PUSH/0-10V / DALI 2/PUSH/0-10V</b> MULTIFUNCTION DRIVER	P. 174
--	--------

<b>DRIVER MULTIFUNZIONE DALI 2/PUSH / DALI 2/PUSH MULTIFUNCTION</b> DRIVER	P. 175
---	--------

<b>KIT EMERGENZA MULTIFUNZIONE / MULTIFUNCTIONAL EMERGENCY KIT</b>	P. 176
--	--------

### DOWNLIGHTS

<b>DOWNLIGHT OSLO ROUND</b> Con cornice intercambiabile / With interchangeable frame	P. 180
--	--------

<b>DOWNLIGHT BIG OSLO ROUND</b> Con cornice intercambiabile / With interchangeable frame	P. 181
--	--------

<b>DOWNLIGHT OSLO SQUARED</b> Con cornice intercambiabile / With interchangeable frame	P. 182
--	--------

<b>DOWNLIGHT BODO CCT</b>	P. 184
---------------------------	--------

<b>DOWNLIGHT BODO II CCT DIMMERABILE</b>	P. 185
--	--------

<b>DOWNLIGHT BODO</b> Downlight orientabile / Adjustable downlight	P. 186
--	--------

<b>GALA</b> Downlight CCT	P. 188
------------------------------	--------

<b>GROV</b> Downlight CCT	P. 189
------------------------------	--------

<b>ANELLI DI FISSAGGIO ORIENTABILI</b> ADJUSTABLE FIXING RINGS	P. 190
---	--------

<b>ANELLO DI FISSAGGIO FISSO CON VETRO FRONTALE IP65</b> IP65 FIXING RING WITH FRONT GLASS	P. 190
---	--------

<b>ANELLI DI FISSAGGIO ORIENTABILI PER GU10</b> ADJUSTABLE FIXING RINGS FOR GU10	P. 191
---	--------

### TRACKLIGHTS

<b>BERNA</b> Sospensione da binario / Track pendant	P. 194
---	--------

<b>ZURIGO</b> Lampada a sospensione / Pendant lamp	P. 195
--	--------

<b>GRAZ</b> Proiettore da binario / Tracklight	P. 196
---	--------

<b>LINZ</b> Faretto spot / Spotlight	P. 197
---	--------

<b>WELS</b> Proiettore da binario / Tracklight	P. 198
---	--------

<b>PERG</b> Proiettore da binario / Tracklight	P. 200
---	--------

<b>PERG DALI</b> Proiettore da binario dimmerabile DALI 2 / DALI 2 dimmable tracklight	P. 202
--	--------

<b>PERG FOOD</b> Proiettore da binario food / Food Tracklight	P. 203
---	--------

<b>BINARI ED ACCESSORI / TRACKLIGHT AND ACCESSORIES</b>	P. 204
---	--------

### STRISCE LED / LED STRIPS

<b>HD LED STRIP IP20 24V</b> Striscia LED / LED Strip	P. 210
--	--------

<b>COLOR STRIP IP20 24V</b> Striscia LED / LED Strip	P. 211
---	--------

<b>SMD LED STRIP IP20 24V</b> Striscia LED / LED Strip	P. 212
---	--------

<b>HD LED STRIP IP54 24V</b> Striscia LED / LED Strip	P. 213
--	--------

<b>SMD LED STRIP IP54 24V</b> Striscia LED / LED Strip	P. 214
---	--------

<b>SMD LED STRIP IP67 24V</b> Striscia LED / LED Strip	P. 215
---	--------

<b>CSP LED STRIP IP20 24V</b> Striscia LED / LED Strip	P. 216
---	--------

<b>COB LED STRIP IP20 24V</b> Striscia LED / LED Strip	P. 217
---	--------

<b>COB LED STRIP IP20 48V</b> Striscia LED / LED Strip	P. 218
---	--------

<b>COB LED STRIP IP65 48V</b> Striscia LED / LED Strip	P. 219
---	--------

<b>DRIVER PER STRIP LED</b> STRIP LED DRIVERS	P. 220
--	--------

<b>DIMMER PER STRIP LED</b> LED STRIP DIMMER	P. 221
---	--------

<b>PROFILI PER STRIP LED</b> LED STRIP PROFILES	P. 222
--	--------

<b>ACCESSORI PER STRIP LED</b> LED STRIP ACCESSORIES	P. 224
---	--------

### MODULI LED / LED MODULES

<b>MOD-A</b> Modulo LED circolare magnetico CCT / CCT magnetic circular LED module	P. 228
---	--------

<b>MOD-B</b> Modulo LED circolare magnetico / Magnetic circular LED module	P. 229
--	--------

<b>MOD-C</b> Modulo LED circolare magnetico CCT / CCT magnetic circular LED module	P. 230
---	--------

<b>MODULO LED SLIM</b> SLIM LED MODULE	P. 232
---	--------

<b>MODULO LED SLIM 12-24V IP65</b> IP65 12-24V LED MODULE	P. 233
--	--------

<b>SEGOVIA LED</b> Accessorio / Accessory	P. 234
--	--------

<b>LAGOS LED</b> Accessorio / Accessory	P. 235
--	--------

### REGLETTE E SISTEMI COMPONIBILI / REGLETTE AND MODULAR SYSTEMS

<b>EVA</b> Plafoniera flat LED CCT / CCT flat LED ceiling light	P. 238
---	--------

<b>LED T5 BAR</b> Sistema modulare di barre LED / LED Modular system	P. 239
--	--------

<b>YGS - Switch Fisico</b> Reglette LED CCT con selettore / CCT LED reglette with selector	P. 240
--	--------

**YGQ - Switch Fisico**  
Reglette LED CCT con selettore /  
CCT LED reglette with selector P. 241

**YGR - Switch Fisico**  
Reglette LED CCT regolabile /  
Adjustable CCT LED reglette P. 242

**YGB**  
Sottopensile CCT / CCT cabinet light P. 244

## PLAFONIERE STAGNE / TRI-PROOF

**PLAFONIERA STAGNA VUOTA PER TUBI LED**  
EMPTY SLIM-TRIPROOF FOR LED TUBES P. 248

**PLAFONIERA STAGNA A LED SLIM**  
SLIM LED TRI-PROOF P. 249

**PLAFONIERA STAGNA A LED SLIM - PASSANTE**  
SLIM LED TRI-PROOF - PASS THROUGH P. 250

**PLAFONIERA STAGNA A LED SLIM - EMERGENZA**  
SLIM LED TRI-PROOF - EMERGENCY P. 251

**PLAFONIERA STAGNA A LED SLIM - RADAR**  
SLIM LED TRI-PROOF - RADAR P. 252

**PLAFONIERA STAGNA A LED SLIM LD3**  
LD3 SLIM LED TRI-PROOF P. 253

## HIGH BAY

**HIGH BAY LED 150**  
Proiettore High bay LED 150W /  
High power Led high bay 150W P. 256

**HIGH BAY LED 200**  
Proiettore High bay LED 200W /  
High power Led high bay 200W P. 257

**SS DOB HIGH BAY**  
Proiettore High Bay LED DOB / DOB  
LED High Bay P. 258

**HIGH BAY MULTI POTENZA**  
Proiettore High Bay multi  
potenza dimmerabile /  
Dimmable multi power LED  
High Bay P. 259

## PROIETTORI / FLOODLIGHTS

**ORLANDO 10**  
Proiettore a Led slim / Slim Led  
floodlight P. 262

**ORLANDO 20**  
Proiettore a Led slim / Slim Led  
floodlight P. 264

**ORLANDO 20 PIR**  
Proiettore a Led slim / Slim Led  
floodlight P. 265

**ORLANDO 30**  
Proiettore a Led slim / Slim Led  
floodlight P. 266

**ORLANDO 30 PIR**  
Proiettore a Led slim / Slim Led  
floodlight P. 267

**ORLANDO 50**  
Proiettore a Led slim / Slim Led  
floodlight P. 268

**ORLANDO 50 PIR**  
Proiettore a Led slim / Slim Led  
floodlight P. 269

**ORLANDO 90**  
Proiettore a Led slim / Slim Led  
floodlight P. 270

**ORLANDO 150**  
Proiettore a Led slim / Slim Led  
floodlight P. 272

**ORLANDO 200**  
Proiettore a Led slim / Slim Led  
floodlight P. 273

**KYOTO 100**  
Proiettore a Led professionale /  
Professional Led floodlight P. 274

**KYOTO 150**  
Proiettore a Led professionale /  
Professional Led floodlight P. 275

**KYOTO 200**  
Proiettore a Led professionale /  
Professional Led floodlight P. 276

**KYOTO 300**  
Proiettore a Led professionale /  
Professional Led floodlight P. 277

**KYOTO 500**  
Proiettore a Led professionale /  
Professional Led floodlight P. 278

**ATLANTA CCT**  
Proiettore a Led / Led floodlight P. 280

**AKRON 2**  
Proiettore a Led 12/24V /  
12/24V Led floodlight P. 282

## RESIDENZIALE / RESIDENTIAL

### INTERNI SOFFITTO / PENDANTS

**LOFT35**  
Lampada a sospensione /  
pendant lamp P. 286

**SANSA**  
Lampada a sospensione /  
pendant lamp P. 289

**URBAN**  
Lampada a sospensione /  
pendant lamp P. 290

### TAVOLO PAVIMENTO / TABLE AND FLOOR

**URBAN DESK S**  
Lampada da tavolo / Table lamp P. 294

**URBAN DESK L**  
Lampada da tavolo / Table lamp P. 297

**URBAN FLOOR**  
Lampada da terra / Floor lamp P. 298

**CARA LED CLIP**  
Lampada con fissaggio a clip /  
Clip wall lamp P. 300

**CARA LED WALL**  
Applique / Wall lamp P. 301

**CARA LED TABLE**  
Lampada da tavolo / Table lamp P. 302

### LAMPADE RICARICABILI / RECHARGEABLE TABLE LAMPS

**SAN**  
Lampada da tavolo ricaricabile /  
Rechargeable table lamp P. 306

**EMMA**  
Lampada da tavolo ricaricabile /  
Rechargeable table lamp P. 308

**EMMA MINI**  
Lampada da tavolo ricaricabile /  
Rechargeable table lamp P. 310

**MAYA**  
Lampada da tavolo ricaricabile /  
Rechargeable table lamp P. 312

**TAG**  
Lampada da tavolo ricaricabile /  
Rechargeable table lamp P. 314

**MAGNETIKA**  
Lampada da tavolo ricaricabile  
multifunzione/ Multifunction  
rechargeable table lamp P. 316

**TIZIA**  
Lampada da tavolo ricaricabile  
solare / Rechargeable table and  
solar lamp P. 318

## GARDEN RESIDENZIALE / RESIDENTIAL OUTDOOR

**ALICANTE**  
Applique / Wall lamp P. 322

**MADRID 7**  
Applique / Wall lamp P. 324

**MADRID 24**  
Applique / Wall lamp P. 326

**NIVES1**  
Applique singola emissione /  
Single emission wall lamp P. 328

**NIVES2**  
Applique doppia emissione/  
Double emission wall lamp P. 330

**LUNA**  
Applique / Wall lamp P. 332

**NORAMINI**  
Applique / Wall lamp P. 334

**MARBELLA SQUARED**  
Applique / Wall lamp P. 336

**MARBELLA ROUND**  
Applique / Wall lamp P. 337

**MARBELLA BIG SQUARED**  
Applique / Wall lamp P. 338

**MARBELLA DUO**  
Applique / Wall lamp P. 340

**MALAGA**  
Plafone / Ceiling lamp P. 342

**ALMERIA**  
Plafone / Ceiling lamp P. 343

**TOLEDO 1**  
Applique singola emissione /  
Single emission wall lamp P. 344

**TOLEDO 2**  
Applique doppia emissione /  
Double emission wall lamp P. 345

**TOLEDO 10**  
Applique / Wall lamp P. 346

**MURCIA 1**  
Applique singola emissione /  
Single emission wall lamp P. 348

**MURCIA 2**  
Applique doppia emissione /  
Double emission wall lamp P. 350

**SUND**  
Applique singola emissione /  
Single emission wall lamp P. 352

**SUND DUO**  
Applique doppia emissione /  
Double emission wall lamp P. 353

**CORDOVA 1**  
Applique singola emissione /  
Single emission wall lamp P. 354

**CORDOVA 2**  
Applique doppia emissione /  
Double emission wall lamp P. 355

**CORDOVA 10**  
Applique / Wall lamp P. 356

# INDICE / INDEX

<b>AVILA</b> Applique con sensore crepuscolare / Wall light with dusk sensor	P. 358	<b>SPIKY1</b> Picchetto da giardino / Outdoor stake light	P. 402	<b>KALAP</b> Testa-palo solare / Solar post-top	P. 444	
<b>ALPILA 1S</b> Applique singola emissione / Single emission wall lamp	P. 360	<b>SPIKY2</b> Picchetto da giardino / Outdoor stake light	P. 403	<b>YUMA6NK</b> Proiettore solare / Solar floodlight	P. 446	
<b>ALPILA 2S</b> Applique doppia emissione / Double emission wall lamp	P. 361	<b>SPIKY3</b> Picchetto da giardino regolabile / Adjustable outdoor stake light	P. 404	<b>YUMA10NK</b> Proiettore solare / Solar floodlight	P. 447	
<b>ALPILA XL</b> Applique doppia emissione / Double emission wall lamp	P. 362	<b>SPIQO</b> Picchetto da giardino / Outdoor stake light	P. 406	<b>YUMA1500NK</b> Proiettore solare con pannello separato / Solar floodlight with separate panel	P. 448	
<b>GRANADA</b> Applique doppia emissione / Double emission wall lamp	P. 363	<b>JET</b> Spot Light LED 24V / 24V LED Spot Light	P. 408	<b>YUMA2800NK</b> Proiettore solare con pannello separato / Solar floodlight with separate panel	P. 449	
<b>GRANADA2</b> Applique singola emissione / Single emission wall lamp	P. 364	<b>PALETO E PICCHETTO PER JET</b> STAKE AND BASE FOR JET	P. 409	<b>YUMA4800NK</b> Proiettore solare con pannello separato / Solar floodlight with separate panel	P. 450	
<b>GRANADA2 DUO</b> Applique doppia emissione / Double emission wall lamp	P. 365	<b>GARDA DESK</b> Lampada da tavolo per esterni / Outdoor table lamp	P. 412	<b>YUMA11NK</b> Proiettore solare stradale / Street solar floodlight	P. 452	
<b>BARREL</b> Lanterna da muro / Wall mounted lantern	P. 366	<b>GARDA FLOOR</b> Lampada da terra per esterni / Outdoor floor lamp	P. 414	<b>YUMA20NK</b> Proiettore solare stradale / Street solar floodlight	P. 454	
<b>JEREZ</b> Applique / Wall lamp	P. 368	<b>SEGNAPASSO / STEP LIGHTS</b>			<b>YUMA40NK</b> Proiettore solare stradale / Street solar floodlight	P. 456
<b>ARVIKA</b> Applique / Wall lamp	P. 369	<b>ARONA 2</b> Segnapasso CCT / CCT step light	P. 418	<b>SOLARE RESIDENZIALE / RESIDENTIAL SOLAR</b>		
<b>MAIORCA</b> Applique / Wall lamp	P. 370	<b>ARONA 3</b> Segnapasso CCT / CCT step light	P. 419	<b>INCLINE2N</b> Proiettore solare / Solar floodlight	P. 460	
<b>SEGOVIA 1</b> Applique / Wall lamp	P. 372	<b>ARONA 1</b> Segnapasso CCT / CCT step light	P. 420	<b>INCLINE4N</b> Proiettore solare / Solar floodlight	P. 461	
<b>LAGOS 1</b> Applique / Wall lamp	P. 374	<b>ARONA 4</b> Segnapasso CCT / CCT step light	P. 421	<b>INCLINE8N</b> Proiettore solare / Solar floodlight	P. 462	
<b>LAGOS 2</b> Applique / Wall lamp	P. 376	<b>ARONA 200</b> Segnapasso CCT per cover magnetica / CCT steplight for magnetic cover	P. 424	<b>YUMA2N</b> Proiettore solare / Solar floodlight	P. 464	
<b>VALENCIA</b> Applique / Wall lamp	P. 378	<b>COVER ARONA 200</b> Cover magnetiche / magnetic covers	P. 424	<b>YUMA8NP</b> Proiettore e picchetto solare / Solar and stake light	P. 465	
<b>VALENCIA2</b> Applique doppia emissione/ Double emission wall lamp	P. 380	<b>ARONA 300</b> Segnapasso CCT per cover magnetica / CCT steplight for magnetic cover	P. 425	<b>MARBELLA10SUN</b> Applique solare / Solar wall lamp	P. 466	
<b>VIGO 1</b> Applique / Wall lamp	P. 382	<b>COVER ARONA 300</b> Cover magnetiche / magnetic covers	P. 425	<b>MARBELLA POLE &amp; SPIKE</b> Paletto per / Pole for MARBELLA10SUN	P. 466	
<b>VIGO 2</b> Applique / Wall lamp	P. 383	<b>BILBAO 3 SQUARED</b> Segnapasso CCT / CCT steplight	P. 428	<b>MARBELLA9SUN</b> Applique solare / Solar wall lamp	P. 468	
<b>VIGO 3</b> Applique / Wall lamp	P. 384	<b>BILBAO 6 SQUARED</b> Segnapasso CCT / CCT steplight	P. 429	<b>MARBELLA POLE &amp; SPIKE</b> Paletto per / Pole for MARBELLA9SUN	P. 468	
<b>VIGO 4</b> Applique / Wall lamp	P. 385	<b>SORIA RETTANGOLARE</b> Segnapasso CCT / CCT step light	P. 430	<b>GLOWA</b> Testa palo solare da giardino / Solar garden post head	P. 470	
<b>CADICE</b> Applique / Wall lamp	P. 388	<b>SORIA QUADRATO</b> Segnapasso CCT / CCT step light	P. 431	<b>YUMA350P</b> Palo solare da giardino / Garden solar bollard light	P. 472	
<b>CADICE BOLLARD</b> Paletto da giardino / Outdoor bollard	P. 389	<b>AITONA QUADRATO</b> Segnapasso calpestabile / Walkover light	P. 432	<b>YUMA1200P</b> Palo solare da giardino / Garden solar bollard light	P. 474	
<b>KALLIO</b> Paletto da giardino / Outdoor bollard	P. 390	<b>AITONA ROTONDO</b> Segnapasso carrabile / Drive-on step light	P. 433	<b>SOLARE TECNICO BRIDO / HYBRID TECHNICAL SOLAR</b>		
<b>IBIZA</b> Paletto da giardino / Outdoor bollard	P. 392	<b>SOLARE TECNICO / TECHNICAL SOLAR</b>				
<b>MERIDA</b> Paletto da giardino / Outdoor bollard	P. 393					
<b>LEON P</b> Lanterna con paletto / Lantern lamp with pole	P. 394					
<b>LEON</b> Lanterna / Lantern lamp	P. 395					
<b>LEON 12 FRAME</b> Lanterna da muro / Wall mounted lantern	P. 396					
<b>LEON 12</b> Lanterna da muro / Wall mounted lantern	P. 398					
<b>LEON 2</b> Plafoniera / Ceiling lamp	P. 400					
<b>KALAP IBRIDO</b> Testa-palo solare ibrido / Hybrid solar post-top	P. 438					
<b>YUMA63HY IBRIDO</b> Proiettore solare stradale ibrido / Hybrid street solar floodlight	P. 440					
<b>CLAY</b> Applique solare / Solar wall lamp	P. 476					
<b>AVENUE</b> Applique solare / Solar wall lamp	P. 478					
<b>MOON</b> Applique solare / Solar wall lamp	P. 480					
<b>YUCCA</b> Lanterna solare / Solar lantern	P. 482					
<b>YUCCAP</b> Lanterna solare con paletto / Solar lantern with pole	P. 484					

**FLAME2N**

Torcia a Led effetto fiamma - solare con sensore crepuscolare / Led torch with flame effect - solar powered & dusk sensor P. 484

## PORTATILI E LEISURE / PORTABLE AND LEISURE

### WORK LIGHTS

**WORK 50**

Lampada da lavoro portatile / Portable worklight P. 490

**WORK 10**

Proiettore portatile / Worklight P. 492

**WORK 20**

Lampada da lavoro portatile / Portable worklight P. 493

**FROG**

Proiettore multiuso ricaricabile / Rechargeable multipurpose worklight P. 494

**LED16**

Flashlight torcia portatile a led ricaricabile / Portable Rechargeable LED Torch P. 496

**TORCIA DA LAVORO / PORTABLE WORKLIGHT**

P. 497

### FLASHLIGHTS & SPORTS LIGHTS

**KIT LUCI DA BICI** P. 500

**HEADLIGHT** P. 500

**AIRAM POWER HEADLIGHT** P. 500

**HEADLIGHT CON SENSORE** P. 501

**TORCIA LED 500lm** P. 501

**TORCIA LED 1500lm** P. 501

**EXPO CLIPPY SAFETY LIGHT LED 12 PZ** P. 502

**EXPO TORCE LED COLORI VARI 12 PZ** P. 502

**EXPO TORCE LED13 COLORI VARI 12 PZ** P. 502

**EXPO WORKLIGHT LED COLORI VARI 9 PZ** P. 503

### PILE ELETTRICHE / BATTERIES

**EVOLUTION + ALKALINE** P. 504

**SUPER ALKALINE MULTIPACK** P. 504

**ALKALINE** P. 505

### NIGHT LIGHTS

**LUCE NOTTURNA POWER LED CREPUSCOLARE** P. 507

**LUCE NOTTURNA POWER LED CREPUSCOLARE + SENSOR** P. 507

**LUCE NOTTURNA POWER LED CREPUSCOLARE ROUND** P. 507

**LAMPADA DA ARMADIO CON SENSORE DI MOVIMENTO** P. 507

**TIPI DI ATTACCO / SOCKETS** P. 508

**GLOSSARIO / GLOSSARY** P. 510

**GARANZIA / WARRANTY** P. 512

**CONDIZIONI DI VENDITA / SALES CONDITIONS** P. 513

**INDICE ALFABETICO PRODOTTI / ALPHABETICAL PRODUCT INDEX** P. 514

# INDICE SORGENTI / LIGHT BULBS INDEX

## IOT / SMART



**GOCCIA STICK SMART  
A60 TUNABLE WHITE**  
P. 37



**GOCCIA OPALE SMART  
RGB + TUNABLE WHITE**  
P. 38



**SFERA OPALE SMART RGB  
+ TUNABLE WHITE**  
P. 38



**OLIVA OPALE SMART RGB  
+ TUNABLE WHITE**  
P. 38



**GLOBO 95 OPALE SMART  
RGB + TUNABLE WHITE**  
P. 39



**REFLECTOR R80 OPALE  
SMART RGB + TUNABLE  
WHITE**  
P. 39



**GU10 SMART RGB +  
TUNABLE WHITE**  
P. 39

## CLASSE A / A CLASS



**A**  
**GOCCIA LED STICK H**  
P. 42



**A**  
**SFERA LED STICK H**  
P. 42



**A**  
**OLIVA LED STICK H**  
P. 43



**A**  
**GLOBO 125 LED STICK H**  
P. 43

## FILAMENTO BIANCO / WHITE FILAMENT



**GOCCIA WHITE FILAMENT**  
P. 45



**SFERA WHITE FILAMENT**  
P. 45



**OLIVA WHITE FILAMENT**  
P. 46



**GLOBO WHITE FILAMENT**  
P. 46

## LED STICK

 <b>CRI &gt;95</b>	 <b>CRI &gt;95</b>	 <b>CRI &gt;95</b>			
<b>GOCCIA LED STICK CRI &gt;95</b> P. 49	<b>SFERA LED STICK CRI &gt;95</b> P. 49	<b>OLIVA LED STICK CRI &gt;95</b> P. 49	<b>GOCCIA LED STICK DIMMERABILE</b> P. 50	<b>SFERA LED STICK DIMMERABILE</b> P. 50	<b>OLIVA LED STICK DIMMERABILE</b> P. 51
					
<b>OLIVA LED STICK SATINATA DIMMERABILE</b> P. 51	<b>GLOBO 125 LED STICK DIMMERABILE</b> P. 52	<b>GLOBO 125 LED SPRING DIMMERABILE</b> P. 52	<b>TUBOLARE T38 LED STICK DIMMERABILE</b> P. 52	<b>GOCCIA LED STICK</b> P. 53	<b>SFERA LED STICK</b> P. 54
					
<b>OLIVA LED STICK</b> P. 55	<b>TORTIGLIONE LED STICK</b> P. 55	<b>FIAMMA LED STICK</b> P. 56	<b>GLOBO 95 LED STICK</b> P. 57	<b>GLOBO 125 LED STICK</b> P. 57	<b>PICCOLA PERA LED STICK</b> P. 58
					
<b>TUBOLARE T20 LED STICK</b> P. 58	<b>TUBOLARE T25 LED STICK</b> P. 59	<b>TUBOLARE T32 LED STICK</b> P. 59	<b>GOCCIA LED STICK SATINATA</b> P. 61	<b>SFERA LED STICK SATINATA</b> P. 61	<b>OLIVA LED STICK SATINATA</b> P. 62
					
<b>TORTIGLIONE LED STICK SATINATA</b> P. 62	<b>FIAMMA LED STICK SATINATA</b> P. 63	<b>GLOBO 125 LED STICK SATINATA</b> P. 63	<b>REFLECTOR R39 LED STICK SATINATA</b> P. 63	<b>REFLECTOR R50 LED STICK SATINATA</b> P. 64	<b>REFLECTOR R63 LED STICK SATINATA</b> P. 64
					
<b>REFLECTOR R80 LED STICK SATINATA</b> P. 64	<b>REFLECTOR R125 LED STICK SATINATA DIMMERABILE</b> P. 65	<b>GOCCIA LED STICK CUPOLA ARGENTATA</b> P. 65	<b>SFERA LED STICK CUPOLA ARGENTATA</b> P. 65	<b>GOCCIA LED STICK CON SENSORE CREPUSCOLARE</b> P. 66	

# INDICE SORGENTI / LIGHT BULBS INDEX

## FULL LIGHT

NEW



GOCCIA FULL LIGHT -  
Classe B  
P. 68



GOCCIA FULL LIGHT  
P. 68



SFERA FULL LIGHT  
P. 69



OLIVA FULL LIGHT  
P. 70



TORTIGLIONE FULL LIGHT  
P. 70



FIAMMA FULL LIGHT  
P. 70



GLOBO 95 FULL LIGHT  
P. 71



GLOBO 125 FULL LIGHT  
P. 71



GOCCIA FULL LIGHT  
DIMMERABILE  
P. 72



SFERA FULL LIGHT  
DIMMERABILE  
P. 72



OLIVA FULL LIGHT  
DIMMERABILE  
P. 72



GLOBO 125 FULL LIGHT  
DIMMERABILE  
P. 73



TUBOLARE T38 FULL LIGHT  
DIMMERABILE  
P. 73

## VINTAGE



EDISON LED STICK GOLD  
P. 76



GOCCIA LED STICK  
GOLD  
P. 76



OLIVA LED STICK GOLD  
P. 76



TORTIGLIONE LED STICK  
GOLD  
P. 77



GLOBO 95 LED STICK  
GOLD  
P. 77



GLOBO 125 LED STICK  
GOLD  
P. 77



GOCCIA F.O.B. STICK  
DIMMERABILE  
P. 78



GLOBO F.O.B. STICK  
DIMMERABILE  
P. 78



BT F.O.B. STICK  
DIMMERABILE  
P. 78



ALVEARE F.O.B. STICK  
DIMMERABILE  
P. 79



UFO F.O.B. STICK  
DIMMERABILE  
P. 79



LANTERNA F.O.B. STICK  
DIMMERABILE  
P. 79

## SMD



GOCCIA OPALE A60  
P. 82



GOCCIA OPALE A67  
P. 83



GOCCIA OPALE A80  
P. 83



SFERA OPALE E27  
P. 84



SFERA OPALE E14  
P. 85



OLIVA OPALE  
P. 86

NEW



GLOBO 95 OPALE  
P. 87



GLOBO 120 OPALE  
P. 87



GOCCIA OPALE  
DIMMERABILE  
P. 88



SFERA OPALE  
DIMMERABILE  
P. 88



OLIVA OPALE  
DIMMERABILE  
P. 88



PICCOLA PERA PER  
FRIGORIFERI  
P. 89



PICCOLA PERA  
P. 89



PICCOLA PERA  
COLORATA  
P. 90



PICCOLA PERA 24V DC  
P. 90



TUBOLARE T37  
P. 91



TUBOLARE T45  
P. 91



REFLECTOR R39  
P. 92



REFLECTOR R50  
P. 92



REFLECTOR R63  
P. 93



REFLECTOR R80  
P. 93



LED GU10 H - 36°  
P. 94



LED GU10 H - 100°  
P. 94



LED GU10 HP - 36°  
P. 95



LED GU10 HP - 100°  
P. 95



LED GU10 - 36°  
P. 96



LED GU10 - 60°  
P. 96



LED GU10 - 110°  
P. 97



LED GU10 HP - 100° -  
DIMMERABILE  
P. 97



LED GU10 DIMMERABILE  
P. 97



LED GU10 ALL-GLASS H  
P. 98



+65°C

LED GU10 ALTA  
TEMPERATURA  
P. 98



LED GU10 ALL-GLASS  
FASCIO STRETTO  
P. 99



LED GU10 ALL-GLASS  
P. 99



LED GU10 ALL-GLASS  
DIMMERABILE  
P. 99



LED MR11  
P. 100

# INDICE SORGENTI / LIGHT BULBS INDEX

## SMD

					
LED MR16 P. 100	LED MR16 ALL-GLASS P. 101	LED MR16 ALL-GLASS DIMMERABILE P. 101	IP 65 LED PAR30 WATERPROOF IP65 DIMMERABILE P.102	IP 65 LED PAR38 WATERPROOF IP65 DIMMERABILE P. 102	LED BISPINA G4 P. 103
					
LED BISPINA G4 SATINATA P. 103	LED BISPINA G4 CHIARA P. 103	LED G9 ALL-GLASS P. 104	LED G9 P. 104	LED G9 DIMMERABILE P. 105	LED G9 COB P. 105
					
LED LINEARE R7S P. 106	LED LINEARE R7S DIMMERABILE P. 106	LED LINEARE R7S 78MM P. 107	LED LINEARE R7S 2000LM DIMMERABILE P. 107	NEW LED LINEARE R7S 3000LM P. 107	PL ALC LED P.108
					
PL AL LED P. 108	PL ALL LED P. 108	CRI>97 LED AR111 CRI>97 DIMMERABILE P. 109	LED GX53 P. 109	LED LINEARLINE 300MM P. 110	LED LINEARLINE 500MM P. 110
					
LED LINEARLINE 1000MM P. 110	LAMPADA ELLITTICA SMD HID P. 111	IP 65 LAMPADA ELLISSOIDALE ALTA POTENZA HID P. 111	IP 65 LAMPADA TUBOLARE ALTA POTENZA HID P. 112		

## SPECIALI / SPECIAL

					
AUTOMATIC ON-OFF GOCCIA OPALE CON SENSORE CREPUSCOLARE P. 114	AUTOMATIC ON-OFF GOCCIA OPALE CON SENS DI MOVIMENTO E CREPUSCOLARE P. 114	GOCCIA OPALE 12/24V AC/DC P. 114	GOCCIA LED FROST PER CELLA FRIGORIFERA -40 °C P. 115	GOCCIA LED ANTIZANZARE P. 115	+60°C GOCCIA LED PER SAUNA +60 °C P. 115

## SPECIALI / SPECIAL



**GOCCIA LED SURGE PROTECTION**  
P. 116



**LED PLANT PAR20 PER CRESCITA PIANTE**  
P. 116



**LED PLANT PAR30 PER CRESCITA PIANTE**  
P. 116



**LAMPADE CCT**  
P. 117

## TUBI LED / LED TUBES



**TUBO LED VETRO T8 A-CLASS**  
P. 118



**TUBO LED VETRO T8 HIGH EFFICIENCY**  
P. 118



**TUBO LED VETRO T8**  
P. 119



**TUBO LED VETRO T8 SE**  
P. 120



**TUBO LED VETRO T8 FOOD**  
P. 120



**TUBO LED VETRO T5 - MAINS**  
P. 121



**CIRCOLINE T9 LED**  
P. 121



**STARTER PER TUBI T8 A LED**  
P. 121

## ALOGENE / HALOGEN



**LINEARE ENERGY SAVING R7S DIMMERABILE**  
P. 124



**SPOT RAGGI INFRAROSSI**  
P. 124

## INCANDESCENZA / INCANDESCENT



**PICCOLA PERA CHIARA**  
P. 125



**+300°C**

**PICCOLA PERA CHIARA PER FORNI 300 °C**  
P. 125

# INDICE SORGENTI / LIGHT BULBS INDEX

## SCARICA IODURI / IODIDE DISCHARGE



**NACHROMA  
ELLISSOIDALE  
DIFFONDENTE**  
P. 126



**NATRALOX SUPER  
TUBOLARE TRASPARENTE**  
P. 126

## LAMPADE UVC / UVC LAMPS



**PL UVC**  
P. 128



**TUBO T5 UVC**  
P. 129



**TUBO T8 UVC**  
P. 129

## PLAFONIERE / CEILING LIGHTS



**IRIS ROUND**  
Plafoniera CCT  
CCT ceiling light  
P. 132



**IRIS SQUARED**  
Plafoniera CCT  
CCT ceiling light  
P. 133



**VAASA**  
Plafoniera CCT  
CCT ceiling light  
P. 134



**VAASA BIG**  
Plafoniera CCT  
CCT ceiling light  
P. 135



**JUPITER**  
Plafoniera PIR  
PIR ceiling light  
P. 136



**LINDA**  
Plafoniera CCT  
CCT ceiling light  
P. 138



**LINDA KIT DI SOSPENSIONE**  
Accessorio kit sospensione  
Pendant kit accessory  
P. 138



**COCO**  
Plafoniera  
Ceiling light  
P. 140



**RIO**  
Plafoniera  
Ceiling light  
P. 142



**RIO RADAR**  
Plafoniera con radar  
Radar ceiling light  
P. 143



**ERIKA ROUND**  
Plafoniera CCT  
CCT ceiling light  
P. 144



**ERIKA SQUARED**  
Plafoniera CCT  
CCT ceiling light  
P. 145



**NORA ROUND**  
Plafoniera CCT  
CCT ceiling light  
P. 146



**NORA SQUARED**  
Plafoniera CCT  
CCT ceiling light  
P. 148



**SONO III PIR**  
Plafoniera PIR  
PIR ceiling light  
P. 150



**GIADA II**  
Plafoniera multifunzione ad  
alta resistenza  
High resistance multifunctional  
ceiling light  
P. 152



**RONDA**  
Plafoniera CCT  
CCT ceiling light  
P. 154



**NEW RONDA BIG**  
Plafoniera CCT  
CCT ceiling light  
P. 155



**SONJA**  
Plafoniera  
Ceiling light  
P. 156



**SONJA OVAL**  
Plafoniera  
Ceiling light  
P. 157



**OVIEDO ROUND**  
Plafoniera CCT  
CCT ceiling light  
P. 158



**NEW OVIEDO OVAL**  
Plafoniera CCT  
CCT ceiling light  
P. 159



**BURGOS**  
Plafoniera CCT  
CCT ceiling light  
P. 160

## PANNELLI LED / LED PANELS



UGR<19

**PANNELLO LED BACKLIT  
600X600 ALTA EFFICIENZA**  
600X600 HIGH EFFICIENCY  
BACKLIT LED PANEL  
P. 164



UGR<19



**PANNELLO LED BACKLIT  
600X600 ALTA EMISSIONE**  
600X600 HIGH EMISSION  
BACKLIT LED PANEL  
P. 165



UGR<19

CRI>90



**PANNELLO LED BACKLIT  
600X600**  
600X600 BACKLIT LED PANEL  
P. 166



UGR<19

**PANNELLO LED BACKLIT  
600X600 - VALUE 4PACK**  
600X600 BACKLIT LED PANEL  
- VALUE 4PACK  
P. 167



UGR<19

CRI>90



**PANNELLO LED BACKLIT  
300X1200**  
300X1200 BACKLIT LED  
PANEL  
P. 168



UGR<19

CRI>90

**PANNELLO LED EDGELIT  
600X600**  
600X600 EDGELIT LED PANEL  
P. 169



UGR<19

CRI>90

**PANNELLO LED EDGELIT  
300X1200**  
300X1200 EDGELIT LED  
PANEL  
P. 170



**DRIVER PER PANNELLI LED**  
DRIVER FOR LED PANELS  
P. 172



**KIT MONTAGGIO PANNELLI**  
PANELS MOUNTING KIT  
P. 172



**DRIVER MULTIFUNZIONE  
DALI 2/PUSH/0-10V**  
DALI 2/PUSH/0-10V  
MULTIFUNCTION DRIVER  
P. 174



**DRIVER MULTIFUNZIONE DALI  
2/PUSH**  
DALI 2/PUSH MULTIFUNCTION  
DRIVER  
P. 175



NEW

**KIT EMERGENZA  
MULTIFUNZIONE**  
MULTIFUNCTIONAL  
EMERGENCY KIT  
P. 176

## DOWNLIGHTS



CCT

**DOWNLIGHT OSLO ROUND**  
Con cornice intercambiabile  
With interchangeable frame  
P. 180



CCT

**DOWNLIGHT BIG OSLO  
ROUND**  
Con cornice intercambiabile  
With interchangeable frame  
P. 181



CCT

**DOWNLIGHT OSLO SQUARED**  
Con cornice intercambiabile  
With interchangeable frame  
P. 182



CCT

**DOWNLIGHT BODO CCT**

P. 184



IP 44/20

CCT



**DOWNLIGHT BODO II CCT  
DIMMERABILE**

P. 185

## DOWNLIGHTS



**DOWNLIGHT BODO**  
Downlight orientabile  
*Adjustable downlight*  
P. 186



**GALA**  
Downlight CCT  
P. 188



**GROV**  
Downlight CCT  
P. 189



**ANELLI DI FISSAGGIO ORIENTABILI**  
*ADJUSTABLE FIXING RINGS*  
P. 190



**ANELLO DI FISSAGGIO FISSO CON VETRO FRONTALE IP65**  
*IP65 FIXING RING WITH FRONT GLASS*  
P. 190

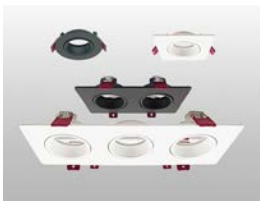

**ANELLI DI FISSAGGIO ORIENTABILI PER GU10**  
*ADJUSTABLE FIXING RINGS FOR GU10*  
P. 191

## TRACK LIGHTS



**BERNA**  
Sospensione da binario  
*Track pendant*  
P. 194



**ZURIGO**  
Lampada a sospensione  
*Pendant lamp*  
P. 195



**GRAZ**  
Proiettore da binario  
*Tracklight*  
P. 196



**LINZ**  
Faretto spot  
*Spotlight*  
P. 197



**WELS**  
Proiettore da binario  
*Tracklight*  
P. 198



**PERG**  
Proiettore da binario  
*Tracklight*  
P. 200



**PERG DALI**  
Proiettore da binario dimmerabile DALI 2  
*DALI 2 dimmable tracklight*  
P. 202



**PERG FOOD**  
Proiettore da binario food  
*Food tracklight*  
P. 203



**BINARI E ACCESSORI**  
*TRACKLIGHT AND ACCESSORIES*  
P. 204

# INDICE TECNICO / TECHNICAL INDEX

## STRISCE LED / LED STRIP



**HD LED STRIP IP20 24V**  
Striscia LED  
LED Strip  
P. 210



**COLOR STRIP IP20 24V**  
Striscia LED  
LED Strip  
P. 211



**SMD LED STRIP IP20 24V**  
Striscia LED  
LED Strip  
P. 212



**HD LED STRIP IP54 24V**  
Striscia LED  
LED Strip  
P. 213



**SMD LED STRIP IP54 24V**  
Striscia LED  
LED Strip  
P. 214



**SMD LED STRIP IP67 24V**  
Striscia LED  
LED Strip  
P. 215



**CSP LED STRIP IP20 24V**  
Striscia LED  
LED Strip  
P. 216

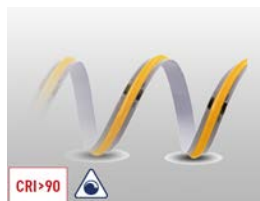

**COB LED STRIP IP20 24V**  
Striscia LED  
LED Strip  
P. 217

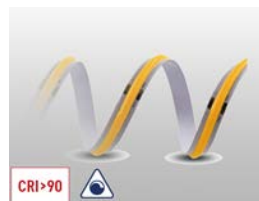

**COB LED STRIP IP20 48V**  
Striscia LED  
LED Strip  
P. 218



**COB LED STRIP IP65 48V**  
Striscia LED  
LED Strip  
P. 219



**DRIVER PER STRIP LED**  
LED STRIP DRIVER  
P. 220



**DIMMER PER STRIP LED**  
LED STRIP DIMMERS  
P. 221

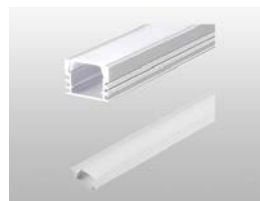

**PROFILI PER STRIP LED**  
LED STRIP PROFILES  
P. 222



**ACCESSORI PER STRIP LED**  
LED STRIP ACCESSORIES  
P. 224

## MODULI LED / LED MODULES



**MOD-A CCT**  
Modulo LED circolare  
magnetico CCT  
CCT magnetic circular LED  
module  
P. 228



**MOD-B**  
Modulo LED circolare  
magnetico  
Magnetic circular LED module  
P. 229



**MOD-C CCT**  
Modulo LED circolare  
magnetico CCT  
CCT magnetic circular LED  
module  
P. 230

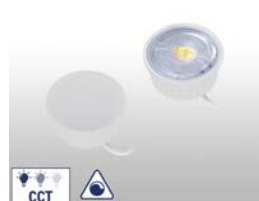

**MODULO LED SLIM**  
SLIM LED MODULE  
P. 232



**MODULO LED 12-24V IP65**  
IP65 12-24V LED MODULE  
P. 233



**SEGOVIA LED**  
Accessorio  
Accessory  
P. 234



**LAGOS LED**  
Accessorio  
Accessory  
P. 235

## REGLETTE SISTEMI COMPONENTI / REGLETTE MODULAR SYSTEMS



CCT

### EVA

Plafoniera flat LED CCT  
CCT flat LED ceiling light  
P. 238

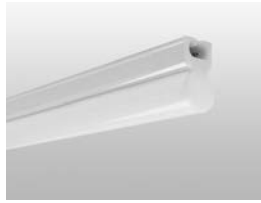

### LED T5 BAR

Sistema modulare di barre LED  
LED modular system  
P. 239



CCT

### YGS - Switch Fisico

Reglette LED CCT con  
selettore  
CCT LED reglette with selector  
P. 240



CCT

### YGQ - Switch Fisico

Reglette LED CCT con  
selettore  
CCT LED reglette with selector  
P. 241



CCT

### YGR - Switch Fisico

Reglette CCT regolabile  
CCT adjustable reglette  
P. 242



CCT

PIR

### YGB

Sottopensile CCT  
CCT cabinet light  
P. 244

## PLAFONIERE STAGNE / TRI-PROOF



IP 65

PLAFONIERA STAGNA VUOTA  
PER TUBI LED  
EMPTY SLIM LED TRI-PROOF  
FOR LED TUBES  
P. 248



IP 65

PLAFONIERA STAGNA A LED  
SLIM  
SLIM LED TRI-PROOF  
P. 249



IP 65

PLAFONIERA STAGNA A LED  
SLIM - PASSANTE  
SLIM LED TRI-PROOF - PASS  
THROUGH  
P. 250



IP 65

PLAFONIERA STAGNA A LED  
SLIM - EMERGENZA  
SLIM LED TRI-PROOF -  
EMERGENCY  
P. 251



IP 65

RADAR

PLAFONIERA STAGNA A LED  
SLIM - RADAR  
SLIM LED TRI-PROOF - RADAR  
P. 252



IP 65

PLAFONIERA STAGNA A LED  
SLIM LD3  
LD3 SLIM LED TRI-PROOF  
P. 253

# INDICE TECNICO / TECHNICAL INDEX

## HIGH BAY



IP 65

**HIGH BAY LED 150**  
Proiettore High bay LED 150W  
High power Led high bay  
150W  
P. 256



IP 65

**HIGH BAY LED 200**  
Proiettore High bay LED 200W  
High power Led high bay  
200W  
P. 257

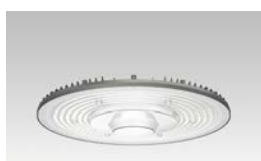

IP 65

**SS DOB HIGH BAY**  
Proiettore High Bay Led DOB  
DOB Led High Bay  
P. 258



NEW

IP 65



**HIGH BAY MULTI POTENZA**  
Proiettore High Bay multi  
potenza dimmerabile  
Dimmable multi power Led  
High Bay  
P. 259

## PROIETTORI / FLOODLIGHTS



IP 65

**ORLANDO 10**  
Proiettore a Led slim  
Slim Led floodlight  
P. 262



IP 65

**ORLANDO 20**  
Proiettore a Led slim  
Slim Led floodlight  
P. 264



IP 65



**ORLANDO 20 PIR**  
Proiettore a Led slim  
Slim Led floodlight  
P. 265



IP 65

**ORLANDO 30**  
Proiettore a Led slim  
Slim Led floodlight  
P. 266



IP 65



**ORLANDO 30 PIR**  
Proiettore a Led slim  
Slim Led floodlight  
P. 267



IP 65

**ORLANDO 50**  
Proiettore a Led slim  
Slim Led floodlight  
P. 268



IP 65



**ORLANDO 50 PIR**  
Proiettore a Led slim  
Slim Led floodlight  
P. 269



IP 65

**ORLANDO 90**  
Proiettore a Led slim  
Slim Led floodlight  
P. 270



IP 65

**ORLANDO 150**  
Proiettore a Led slim  
Slim Led floodlight  
P. 272



IP 65

**ORLANDO 200**  
Proiettore a Led slim  
Slim Led floodlight  
P. 273



IP 66

**KYOTO 100**  
Proiettore a Led professionale  
Professional Led floodlight  
P. 274



IP 66

**KYOTO 150**  
Proiettore a Led professionale  
Professional Led floodlight  
P. 275



IP 66

**KYOTO 200**  
Proiettore a Led professionale  
Professional Led floodlight  
P. 276



IP 66

**KYOTO 300**  
Proiettore a Led professionale  
Professional Led floodlight  
P. 277



IP 66

**KYOTO 500**  
Proiettore a Led professionale  
Professional Led floodlight  
P. 278



IP 65



**ATLANTA CCT**  
Proiettore a Led  
Led floodlight  
P. 280



IP 65

**AKRON 2**  
Proiettore a Led 12/24V  
12/24V Led floodlight  
P. 282

## INTERNI SOFFITTO / PENDANTS



**LOFT35**  
Lampada a sospensione  
*Pendant lamp*  
P. 286



**SANSÀ**  
Lampada a sospensione  
*Pendant lamp*  
P. 289



**URBAN**  
Lampada a sospensione  
*Pendant lamp*  
P. 290

## TAVOLO E PAVIMENTO / TABLE AND FLOOR



**URBAN DESK S**  
Lampada da tavolo  
*Table lamp*  
P. 294



**URBAN DESK L**  
Lampada da tavolo  
*Table lamp*  
P. 297



**URBAN FLOOR**  
Lampada da terra  
*Floor lamp*  
P. 298



**CARA LED CLIP**  
Lampada con fissaggio a clip  
*Clip wall lamp*  
P. 300



**CARA LED WALL**  
Applique  
*Wall lamp*  
P. 301



**CARA LED TABLE**  
Lampada da tavolo  
*Table lamp*  
P. 302

## LAMPADIE DA TAVOLO RICARICABILI / RECHARGEABLE TABLE LAMPS



IP 44

**SAN**  
Lampada da tavolo  
ricaricabile  
*Rechargeable table lamp*  
P. 306



IP 54

**EMMA**  
Lampada da tavolo  
ricaricabile  
*Rechargeable table lamp*  
P. 308



IP 54

**EMMA MINI**  
Lampada da tavolo  
ricaricabile  
*Rechargeable table lamp*  
P. 310



IP 54

**MAYA**  
Lampada da tavolo  
ricaricabile  
*Rechargeable table lamp*  
P. 312



IP 54

**TAG**  
Lampada da tavolo  
ricaricabile  
*Rechargeable table lamp*  
P. 314



IP 54

**MAGNETIKA**  
Lampada da tavolo  
ricaricabile multifunzione  
*Multifunction rechargeable  
table lamp*  
P. 316



IP 54

**TIZIA**  
Lampada da tavolo  
ricaricabile solare  
*Rechargeable table and solar  
lamp*  
P. 318

## GARDEN RESIDENZIALE / RESIDENTIAL OUTDOOR



IP 54 CCT

**ALICANTE**  
Applique  
Wall lamp  
P. 322



IP 65 CCT

**MADRID 7**  
Applique  
Wall lamp  
P. 324



IP 65 CCT

**MADRID 24**  
Applique  
Wall lamp  
P. 326



IP 65 CCT

**NIVES1**  
Applique singola emissione  
Single emission wall lamp  
P. 328



IP 65 CCT

**NIVES2**  
Applique doppia emissione  
Double emission wall lamp  
P. 330



IP 54 CCT

**LUNA**  
Applique  
Wall lamp  
P. 332



IP 65 CCT POWER

**NORAMINI**  
Applique  
Wall lamp  
P. 334



IP 65 CCT

**MARBELLA SQUARED**  
Applique  
Wall lamp  
P. 336



IP 65 CCT

**MARBELLA ROUND**  
Applique  
Wall lamp  
P. 337



IP 65 CCT

**MARBELLA BIG SQUARED**  
Applique  
Wall lamp  
P. 338



IP 65 CCT

**MARBELLA DUO**  
Applique  
Wall lamp  
P. 340



IP 65

**MALAGA**  
Plafone  
Ceiling lamp  
P. 342



IP 65

**ALMERIA**  
Plafone  
Ceiling lamp  
P. 343



IP 65

**TOLEDO 1**  
Applique singola emissione  
Single emission wall lamp  
P. 344



IP 65

**TOLEDO 2**  
Applique doppia emissione  
Double emission wall lamp  
P. 345



IP 65 CCT

**TOLEDO 10**  
Applique  
Wall lamp  
P. 346



IP 65

**MURCIA 1**  
Applique singola emissione  
Single emission wall lamp  
P. 348



IP 65

**MURCIA 2**  
Applique doppia emissione  
Double emission wall lamp  
P. 350



IP 44

**SUND**  
Applique singola emissione  
Single emission wall lamp  
P. 352



IP 44

**SUND DUO**  
Applique doppia emissione  
Double emission wall lamp  
P. 353



IP 65

**CORDOVA 1**  
Applique singola emissione  
Single emission wall lamp  
P. 354



IP 65

**CORDOVA 2**  
Applique doppia emissione  
Double emission wall lamp  
P. 355



IP 65 CCT

**CORDOVA 10**  
Applique  
Wall lamp  
P. 356



IP 44 AUTOMATIC ON/OFF

**AVILA**  
Applique con sensore  
crepuscolare  
Wall light with dusk sensor  
P. 358



IP 44

**ALPPILA 1S**  
Applique singola emissione  
Single emission wall lamp  
P. 360



IP 44

**ALPPILA 2S**  
Applique doppia emissione  
Double emission wall lamp  
P. 361



IP 44

**ALPPILA XL**  
Applique doppia emissione  
Double emission wall lamp  
P. 362



IP 54

**GRANADA**  
Applique doppia emissione  
Double emission wall lamp  
P. 363



IP 65



















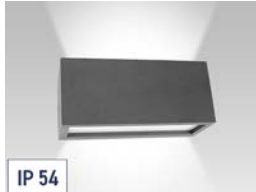









**GRANADA2**  
Applique singola emissione  
Single emission wall lamp  
P. 364



IP 65

**GRANADA2 DUO**  
Applique doppia emissione  
Double emission wall lamp  
P. 365

## GARDEN RESIDENZIALE / RESIDENTIAL OUTDOOR

 <p>IP 44</p> <p><b>BARREL</b> Lanterna da muro Wall mounted lantern P. 366</p>	 <p>IP 44</p> <p><b>JEREZ</b> Applique Wall lamp P. 368</p>	 <p>IP 44</p> <p><b>ARVIKA</b> Applique Wall lamp P. 369</p>	 <p>IP 54 CCT</p> <p><b>MAIORCA</b> Applique Wall lamp P. 370</p>	 <p>IP 54</p> <p><b>SEGOVIA 1</b> Applique Wall lamp P. 372</p>
 <p>IP 54 CCT</p> <p><b>LAGOS 1</b> Applique Wall lamp P. 374</p>	 <p>IP 54 CCT</p> <p><b>LAGOS 2</b> Applique Wall lamp P. 376</p>	 <p>IP 54</p> <p><b>VALENCIA</b> Applique Wall lamp P. 378</p>	 <p>IP 54</p> <p><b>VALENCIA 2</b> Applique doppia emissione Double emission wall lamp P. 380</p>	 <p>IP 54</p> <p><b>VIGO 1</b> Applique Wall lamp P. 382</p>
 <p>IP 54</p> <p><b>VIGO 2</b> Applique Wall lamp P. 383</p>	 <p>IP 54</p> <p><b>VIGO 3</b> Applique Wall lamp P. 384</p>	 <p>IP 54</p> <p><b>VIGO 4</b> Applique Wall lamp P. 385</p>	 <p>IP 44</p> <p><b>CADICE</b> Applique Wall lamp P. 388</p>	 <p>IP 44</p> <p><b>CADICE BOLLARD</b> Paletto da giardino Outdoor bollard P. 389</p>
 <p>IP 44</p> <p><b>KALLIO</b> Paletto da giardino Outdoor bollard P. 390</p>	 <p>IP 65</p> <p><b>IBIZA</b> Paletto da giardino Outdoor bollard P. 392</p>	 <p>IP 65</p> <p><b>MERIDA</b> Paletto da giardino Outdoor bollard P. 393</p>	 <p>IP 44</p> <p><b>LEON P</b> Lanterna con paletto Lantern lamp with pole P. 394</p>	 <p>IP 44</p> <p><b>LEON</b> Lanterna Lantern lamp P. 395</p>
 <p>IP 65 CCT</p> <p><b>LEON 12 FRAME</b> Lanterna da muro Wall mounted lantern P. 396</p>	 <p>IP 65 CCT</p> <p><b>LEON 12</b> Lanterna da muro Wall mounted lantern P. 398</p>	 <p>IP 65</p> <p><b>LEON 2</b> Plafoniera Ceiling lamp P. 400</p>	 <p>NEW</p> <p>IP 65</p> <p><b>SPIKY1</b> Picchetto da giardino Outdoor stake light P. 402</p>	 <p>IP 65</p> <p><b>SPIKY2</b> Picchetto da giardino Outdoor stake light P. 403</p>
 <p>IP 65</p> <p><b>SPIKY3</b> Picchetto da giardino regolabile Adjustable outdoor stake light P. 404</p>	 <p>NEW</p> <p>IP 65</p> <p><b>SPIKO</b> Picchetto da giardino Outdoor stake light P. 406</p>	 <p>NEW</p> <p>IP 65</p> <p><b>JET</b> Spot Light LED 24V 24V LED Spot Light P. 408</p>	 <p>NEW</p> <p>IP 65</p> <p><b>PALETTO E PICCHETTO PER JET</b> STAKE AND BASE FOR JET P. 409</p>	 <p>IP 44</p> <p><b>GARDA DESK/FLOOR</b> Lampade per esterni Outdoor lamps P. 412-414</p>

## SEGNAPASSO / STEP LIGHTS



IP 65 CCT EMERGENCY

**ARONA 2**  
Segnapasso CCT  
CCT step light  
P. 418



IP 65 CCT EMERGENCY

**ARONA 3**  
Segnapasso CCT  
CCT step light  
P. 419



IP 66 CCT

**ARONA 1**  
Segnapasso CCT  
CCT step light  
P. 420



NEW  
IP 65 CCT

**ARONA 4**  
Segnapasso CCT  
CCT step light  
P. 421



CCT

**ARONA 200**  
Segnapasso CCT per cover  
magnetica  
CCT step light for magnetic  
cover  
P. 424

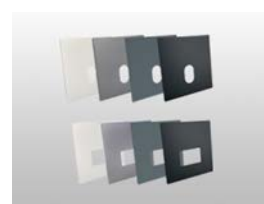

**COVER ARONA 200**  
Cover magnetiche  
Magnetic covers  
P. 424



CCT

**ARONA 300**  
Segnapasso CCT per cover  
magnetica  
CCT step light for magnetic  
cover  
P. 425



**COVER ARONA 300**  
Cover magnetiche  
Magnetic covers  
P. 425



IP 65 CCT

**BILBAO 3 SQUARED**  
Segnapasso CCT  
CCT step light  
P. 428



IP 65 CCT

**BILBAO 6 SQUARED**  
Segnapasso CCT  
CCT step light  
P. 429



IP 65 CCT

**SORIA RETTANGOLARE**  
Segnapasso CCT  
CCT step light  
P. 430



IP 65 CCT

**SORIA QUADRATO**  
Segnapasso CCT  
CCT step light  
P. 431



IP 67 IK 10

**AITONA QUADRATO**  
Segnapasso calpestabile  
Walk-over step light  
P. 432



NEW  
IP 67 IK 10

**AITONA ROTONDO**  
Segnapasso carrabile  
Drive-over step light  
P. 433

## SOLARE TECNICO IBRIDO / HYBRID TECHNICAL SOLAR



NEW  
IP 65 HYBRID CCT PIR

**KALAP IBRIDO**  
Testa-palo solare ibrido  
Hybrid solar post-top  
P. 438



NEW  
IP 65 HYBRID CCT PIR

**YUMA63HY IBRIDO**  
Proiettore solare stradale  
ibrido  
Hybrid street solar floodlight  
P. 440



## SOLARE TECNICO / TECHNICAL SOLAR



IP 65 CCT PIR

### KALAP

Testa-palo solare  
Solar post-top  
P. 444



IP 65 CCT PIR

### YUMA6NK

Proiettore solare  
Solar floodlight  
P. 446



IP 65 CCT PIR

### YUMA10NK

Proiettore solare  
Solar floodlight  
P. 447



IP 65 CCT PIR

### YUMA1500NK

Proiettore solare con pannello  
separato  
Solar floodlight with separate  
panel  
P. 448



IP 65 CCT PIR

### YUMA2800NK

Proiettore solare con pannello  
separato  
Solar floodlight with separate  
panel  
P. 449



IP 65 CCT PIR

### YUMA4800NK

Proiettore solare con pannello  
separato  
Solar floodlight with separate  
panel  
P. 450



IP 65 CCT PIR

### YUMA11NK

Proiettore solare stradale  
Street solar floodlight  
P. 452



IP 65 CCT PIR

### YUMA20NK

Proiettore solare stradale  
Street solar floodlight  
P. 454



IP 65 CCT PIR

### YUMA40NK

Proiettore solare stradale  
Street solar floodlight  
P. 456

## SOLARE RESIDENZIALE / RESIDENTIAL SOLAR



IP 65 PIR

### INCLINE2N

Proiettore solare  
Solar floodlight  
P. 460



IP 65 PIR

### INCLINE4N

Proiettore solare  
Solar floodlight  
P. 461



IP 65 PIR

### INCLINE8N

Proiettore solare  
Solar floodlight  
P. 462



IP 65 PIR

### YUMA2N

Proiettore solare  
Solar floodlight  
P. 464



IP 54 PIR

### YUMA8NP

Proiettore e picchetto solare  
Solar and stake light  
P. 465



IP 65 CCT RADAR

### MARBELLA10SUN

Applique solare  
Solar wall lamp  
P. 466



### MARBELLA POLE & SPIKE

Paletto per / Pole for  
MARBELLA10SUN  
P. 466



IP 65 RADAR

### MARBELLA9SUN

Applique solare  
Solar wall lamp  
P. 468



### MARBELLA POLE & SPIKE

Paletto per / Pole for  
MARBELLA9SUN  
P. 468



IP 65 CCT PIR

### GLOWA

Testa palo solare da giardino  
Solar garden post head  
P. 470

## SOLARE RESIDENZIALE / RESIDENTIAL SOLAR



IP 65 CCT

### YUMA350P

Palo solare da giardino  
Garden solar bollard light  
P. 472



IP 65 PIR

### YUMA1200P

Palo solare da giardino  
Garden solar bollard light  
P. 474



IP 65 PIR

### CLAY

Applique solare  
Solar wall lamp  
P. 476



IP 54 PIR

### AVENUE

Applique solare  
Solar wall lamp  
P. 478



IP 54 PIR

### MOON

Applique solare  
Solar wall lamp  
P. 480



IP 54

### YUCCA

Lanterna solare  
Solar lantern  
P. 482



IP 54

### YUCCAP

Lanterna solare con paletto  
Solar lantern with pole  
P. 484



IP 65

### FLAME2N

Torcia a Led effetto  
fiamma - solare con sensore  
crepuscolare  
Led torch with flame effect -  
solar powered & dusk sensor  
P. 486

## WORK LIGHTS



IP 54 IK 08

### WORK 50

Lampada da lavoro portatile  
Portable worklight  
P. 490



IP 54 IK 08 CCT

### WORK 10

Proiettore portatile  
Worklight  
P. 492



IP 54 IK 08

### WORK 20

Lampada da lavoro portatile  
Portable worklight  
P. 493



IP 54 IK 08 CCT

### FROG

Proiettore multiuso ricaricabile  
Rechargeable multipurpose  
worklight  
P. 494



### LED16

Flashlight torcia portatile a led  
ricaricabile  
Portable Rechargeable LED  
Torch  
P. 496



NEW

TORCIA DA LAVORO  
PORTABLE WORKLIGHT  
P. 497

## FLASHLIGHTS & SPORTS LIGHTS

<p><b>NEW</b></p>  <p><b>IP 44</b></p> <p><b>KIT LUCI DA BICI</b> P. 500</p>	<p><b>NEW</b></p>  <p><b>HEADLIGHT</b> P. 500</p>	 <p><b>AIRAM POWER HEADLIGHT</b> P. 500</p>	<p><b>NEW</b></p>  <p><b>HEADLIGHT CON SENSORE</b> P. 501</p>	<p><b>NEW</b></p>  <p><b>IP 44</b></p> <p><b>TORCIA LED 500lm</b> P. 501</p>
<p><b>NEW</b></p>  <p><b>IP 44</b></p> <p><b>TORCIA LED 1500lm</b> P. 501</p>	 <p><b>EXPO CLIPPY SAFETY LIGHT LED 12 PZ</b> P. 502</p>	 <p><b>EXPO TORCE LED COLORI VARI 12 PZ</b> P. 502</p>	 <p><b>EXPO TORCE GUMLIGHT SHOT LED COLORI VARI 12 PZ</b> P. 502</p>	 <p><b>EXPO WORKLIGHT LED COLORI VARI 9 PZ</b> P. 503</p>

## PILE / BATTERIES

 <p><b>EVOLUTION + ALKALINE</b> P. 504</p>	 <p><b>SUPER ALKALINE MULTIPACK</b> P. 504</p>	 <p><b>ALKALINE</b> P. 505</p>
---	---	---

## NIGHT LIGHTS / LAMPADINE NOTTURNE

 <p><b>LUCE NOTTURNA POWER LED CREPUSCOLARE</b> NIGHT LIGHT POWER LED DUSK SENSOR P. 507</p>	 <p><b>LUCE NOTTURNA POWER LED CREPUSCOLARE + SENSOR</b> NIGHT LIGHT POWER LED WITH SENSOR P. 507</p>	 <p><b>LUCE NOTTURNA POWER LED CREPUSCOLARE ROUND</b> ROUND NIGHT LIGHT POWER LED WITH DUSK SENSOR P. 507</p>	 <p><b>LAMPADA DA ARMADIO CON SENSORE DI MOVIMENTO</b> WARDROBE LAMP WITH MOTION SENSOR P. 507</p>
---	--	--	---

# SHOT

BOT LIGHTING

## LA TUA LUCE PERSONALIZZABILE YOUR CUSTOMIZABLE LIGHT



**CREA LA TUA ATMOSFERA / CREATE YOUR ATMOSPHERE**  
Personalizza i tuoi ambienti con **16 milioni di combinazioni di colori**.  
*Customize your spaces with 16 million color combinations.*



**DANZA CON LE LUCI / DANCE WITH THE LIGHTS**  
Crea un'atmosfera di relax o cambia le luci a ritmo della tua musica preferita.  
*Create a relaxing atmosphere or change the lights to the rhythm of your favorite music.*



**PERSONALIZZABILE / CUSTOMIZABLE**  
Imposta le tue luci tramite app Tuya e gli assistenti vocali più noti sul mercato.  
*Set your lights via the Tuya app and the most popular voice assistants on the market.*



**GESTIONE SCENARI / SCENE MANAGEMENT**  
Crea la tua scena per ogni situazione.  
*Create your own scene for every situation.*



**TUNABLE WHITE 2700-6500K**  
Bianco più fedele grazie alla combinazione di 2 tonalità di bianco.  
*More accurate white thanks to the combination of 2 shades of white.*

**RGB**

**RGB COLOURS**  
LED RGB per il controllo completo del colore.  
*RGB LED for complete color control.*



**ALEXA E GOOGLE ASSISTANT**  
Gestisci le luci con le skill dei tuoi assistenti digitali preferiti.  
*Manage your lights with the skills of your favorite digital assistants.*



**TUYA SYSTEM**  
Controlla tutti i tuoi dispositivi preferiti all'interno della piattaforma Tuya.  
*Control all your favorite devices within the Tuya platform.*



Scarica su  
**App Store**



DISPONIBILE SU  
**Google Play**

Powered by

**tuya**

Intelligence  
Inside



### PER LA QUALITÀ DELLA VITA / FOR QUALITY OF LIFE

Luci basate sul bioritmo. La temperatura di colore e la dimmerazione si adattano automaticamente al ritmo circadiano, ideale per chi lavora.

*Lights based on biorhythm. Color temperature and dimming adjust to the circadian rhythm, ideal for workers.*



### PROGRAMMAZIONE QUOTIDIANA / MODALITÀ SLEEP & WAKE UP

Accendi e dimmeri le luci automaticamente con timer nei giorni prestabiliti.

*Daily Programming / Sleep & Wake Up Mode. Automatically turn on and dim the lights with a timer on preset days.*



### PER LA SICUREZZA / FOR YOUR SECURITY

Arrivo e Uscita - Geolocalizzazione. Gestione automatica delle luci quando entri o esci di casa tramite geolocalizzazione.

*Coming & Leaving Home - Geolocation. Automatic light management when you enter or leave your house via geolocation.*



### INTEGRAZIONE CON SENSORI DI MOVIMENTO / INTEGRATION WITH MOTION SENSORS

Controlla le luci con sensori di movimento e accensione casuale per simulare la tua presenza.

*Control lights with motion sensors and randomly turn them on to simulate your presence.*



## GOCCIA STICK SMART A60 TUNABLE WHITE 220-240V

BTL CATEGORIA SCONTO 21

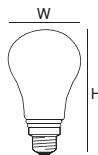

\_ Personalizzabile: imposta le tue luci tramite app Tuya e gli assistenti vocali più noti nel mercato.

\_ Customizable: set your lights via Tuya app and the most popular voice assistants in the market.



W	W=	BASE	K	lm		H x W mm	CODICE	EAN		
6,5	60	E27	2700 6500	806	330°	108x60	A60WT60TW-S	8031453024413	10/50	



## GOCCIA OPALE SMART RGB + TUNABLE WHITE 220-240V

BTL CATEGORIA SCONTO 21

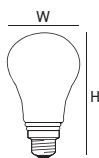

\_ Personalizzabile: imposta le tue luci tramite app Tuya e gli assistenti vocali piu' noti nel mercato.

\_ Customizable: set your lights via Tuya app and the most popular voice assistants in the market.



W	W=	BASE	K	lm		H x W mm	CODICE	EAN		
10,0	75	E27	 2700 6500	1055	220°	120x60	<b>A60WT75RTW</b>	8031453024406	10/50	



## SFERA OPALE SMART RGB + TUNABLE WHITE 220-240V

BTL CATEGORIA SCONTO 21

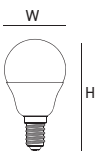

\_ Personalizzabile: imposta le tue luci tramite app Tuya e gli assistenti vocali piu' noti nel mercato.

\_ Customizable: set your lights via Tuya app and the most popular voice assistants in the market.



W	W=	BASE	K	lm		H x W mm	CODICE	EAN		
4,9	40	E14	 2700 6500	470	180°	90x45	<b>P45WT40RTW</b>	8031453025311	10/100	



## OLIVA OPALE SMART RGB + TUNABLE WHITE 220-240V

BTL CATEGORIA SCONTO 21

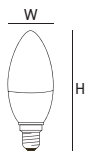

\_ Personalizzabile: imposta le tue luci tramite app Tuya e gli assistenti vocali piu' noti nel mercato.

\_ Customizable: set your lights via Tuya app and the most popular voice assistants in the market.



W	W=	BASE	K	lm		H x W mm	CODICE	EAN		
5,0	40	E14	 2700 6500	470	200°	115x39	<b>C37WT40RTW</b>	8031453024420	10/100	



**GLOBO 95 OPALE SMART RGB + TUNABLE WHITE 220-240V**

BTL CATEGORIA SCONTO 21

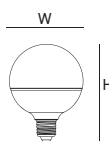

\_ Personalizzabile: imposta le tue luci tramite app Tuya e gli assistenti vocali piu' noti nel mercato.

\_ Customizable: set your lights via Tuya app and the most popular voice assistants in the market.



W	W=	BASE	K	lm		H x W mm	CODICE	EAN		
12,0	100	E27	2700 6500	1521	180°	137x95	D95WT100RTW	8031453025304	10/50	



**REFLECTOR R80 OPALE SMART RGB + TUNABLE WHITE 220-240V**

BTL CATEGORIA SCONTO 21

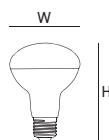

\_ Personalizzabile: imposta le tue luci tramite app Tuya e gli assistenti vocali piu' noti nel mercato.

\_ Customizable: set your lights via Tuya app and the most popular voice assistants in the market.



W	W=	BASE	K	lm		H x W mm	CODICE	EAN		
8,5	60	E27	2700 6500	806	180°	115x80	R80WT60RTW	8031453025298	10/50	



**GU10 SMART RGB + TUNABLE WHITE 220-240V**

BTL CATEGORIA SCONTO 21

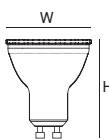

\_ Personalizzabile: imposta le tue luci tramite app Tuya e gli assistenti vocali piu' noti nel mercato.

\_ Customizable: set your lights via Tuya app and the most popular voice assistants in the market.



W	W=	BASE	K	lm		H x W mm	CODICE	EAN		
5,0	32	GU10	2700 6500	350	100°	58x50	GU10WT35RTW	8031453024437	10/100	

## SORGENTI ULTRA EFFICIENTI IN NUOVA CLASSE A ULTRA EFFICIENT SOURCES IN NEW A CLASS

A

Bot Lighting presenta la nuova gamma di sorgenti luminose ultraefficienti in classe A, progettata per offrire a consumatori e professionisti un risparmio energetico fino al 45% rispetto alle sorgenti LED di ultima generazione. Una soluzione all'avanguardia che unisce efficienza, prestazioni e sostenibilità.

*Bot Lighting presents its new range of ultra-efficient Class A light sources, designed to offer consumers and professionals energy savings of up to 45% compared with the latest-generation LED light sources. An advanced solution that combines efficiency, performance, and sustainability.*



**GOCCIA LED STICK H**  
P. 42



**SFERA LED STICK H**  
P. 42



**OLIVA LED STICK H**  
P. 43

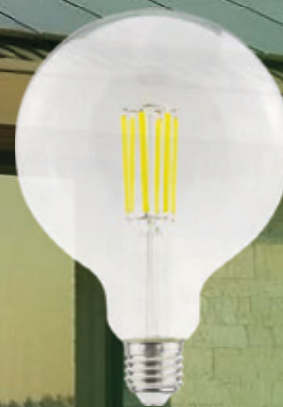

**GLOBO 125 LED STICK H**  
P. 43



**LED GUTO H**  
P. 94



**TUBO LED VETRO T8**  
**A-CLASS**  
P. 118



## ALTA EFFICIENZA

Queste nuove sorgenti offrono una efficienza di oltre 210 lm/W.

## HIGH EFFICIENCY

*These new light sources offer an efficiency of over 210 lm/W.*



## MINORI CONSUMI

I consumi si riducono fino al 45% rispetto alle precedenti lampadine LED Botlighting, con minori emissioni di CO2.

## LESS CONSUMPTION

*Consumption is reduced by up to 45% compared to previous Botlighting LED bulbs, resulting in significant lower CO2 emissions.*



## PROGETTATE PER DURARE

Le nuove sorgenti in classe A sono progettate per un utilizzo duraturo. Questo riduce anche la produzione di rifiuti elettronici (RAEE) a tutto vantaggio dell'ambiente.

## DESIGN TO LAST

*The new class A light sources are designed for long-lasting use. This also reduces electronic waste (WEEE), benefiting the environment.*

## CRI > 80

## QUALITA' E COMFORT VISIVO

Le sorgenti luminose non hanno componenti verdastre, garantendo un comfort visivo ottimale in ogni situazione.

## QUALITY AND VISUAL COMFORT

*The light sources have no greenish components, ensuring optimal visual comfort in every situation.*

**BOT LIGHTING: LA LUCE CHE RISPETTA L'AMBIENTE**  
Tecnologia efficiente, consumi ridotti e maggiore attenzione al futuro del pianeta.

**BOT LIGHTING: LIGHTING THAT RESPECTS THE ENVIRONMENT**  
Efficient technology, reduced consumption, and greater care for the future of our planet.



## GOCCIA LED STICK H 220-240V

BTL CATEGORIA SCONTO 21

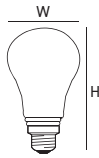

W	W=	BASE	K	lm		H x W mm	CODICE	EAN		
3.8	60	E27	3000	806	330°	108x60	WLH1008X2	8031453028046	10/50	
3.8	60	E27	4000	806	330°	108x60	WLH1008X3	8031453029159	10/50	
5.0	75	E27	3000	1055	330°	108x60	WLH1010X2	8031453029166	10/50	
5.0	75	E27	4000	1055	330°	108x60	WLH1010X3	8031453029173	10/50	
7.2	100	E27	3000	1521	330°	108x60	WLH1015X2B	8031453029180	10/50	
7.2	100	E27	4000	1521	330°	108x60	WLH1015X3B	8031453029197	10/50	
7.2	100	E27	3000	1521	330°	126x70	WLH1015X2	8031453028053	10/50	

## SFERA LED STICK H 220-240V

BTL CATEGORIA SCONTO 21

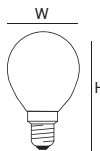

W	W=	BASE	K	lm		H x W mm	CODICE	EAN		
2.2	40	E14	3000	470	330°	80x45	WLH3004X2	8031453029241	10/50	
2.2	40	E14	4000	470	330°	80x45	WLH3004X3	8031453029258	10/50	
3.8	60	E14	3000	806	330°	80x45	WLH3008X2	8031453029265	10/50	
3.8	60	E14	4000	806	330°	80x45	WLH3008X3	8031453029272	10/50	

**OLIVA LED STICK H 220-240V**



BTL CATEGORIA SCONTO 21



W	W=	BASE	K	lm		H x W mm	CODICE	EAN		
2.2	40	E14	3000	470	330°	97x35	WLH2004X2	8031453029203	10/50	
2.2	40	E14	4000	470	330°	97x35	WLH2004X3	8031453029210	10/50	
3.8	60	E14	3000	806	330°	97x35	WLH2008X2	8031453029227	10/50	
3.8	60	E14	4000	806	330°	97x35	WLH2008X3	8031453029234	10/50	

**GLOBO 125 LED STICK H 220-240V**

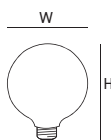

BTL CATEGORIA SCONTO 21



W	W=	BASE	K	lm		H x W mm	CODICE	EAN		
7.2	100	E27	3000	1521	330°	178x125	WLH4015X2	8031453029289	5/20	
7.2	100	E27	4000	1521	330°	178x125	WLH4015X3	8031453029296	5/20	

# SHOT

BOT LIGHTING

**LAMPAD E LED  
FILAMENTO BIANCO**  
WHITE FILAMENT  
LED BULBS

## **IDEALI PER AMBIENTI DI DESIGN**

Belle anche da spente, le lampade a filamento bianco di ultima generazione sono progettate per apparecchi dal design minimalista e moderno, creando un'atmosfera elegante e pulita

## **IDEAL FOR CONTEMPORARY INTERIORS**

*Beautiful even when off, these white filament bulbs are the perfect match for minimalist, modern fixtures, bringing a clean and elegant touch to any space.*



**GOCCIA WHITE FILAMENT 220-240V**

BTL CATEGORIA SCONTO 21

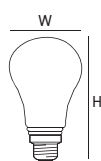

IP 20

20.000h  
2 ANNI GARANZIA

20.000



W	W=	BASE	K	lm		H x W mm	CODICE	EAN		
7,0	60	E27	3000	806	330°	108x60	WLW1008X2BB	8031453029302	10/50	
7,0	60	E27	4000	806	330°	108x60	WLW1008X3	8031453030803	10/50	
8,5	75	E27	3000	1055	330°	108x60	WLW1010X2BB	8031453029319	10/50	
8,5	75	E27	4000	1055	330°	108x60	WLW1010X3	8031453030810	10/50	
10,5	100	E27	3000	1521	330°	108x60	WLW1015X2BB	8031453029326	10/50	
10,5	100	E27	4000	1521	330°	108x60	WLW1015X3	8031453030827	10/50	



**SFERA WHITE FILAMENT 220-240V**

BTL CATEGORIA SCONTO 21

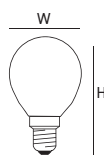

IP 20

20.000h  
2 ANNI GARANZIA

20.000



W	W=	BASE	K	lm		H x W mm	CODICE	EAN		
4,5	40	E14	3000	470	330°	80x45	WLW3004X2BB	8031453030926	10/50	
4,5	40	E14	4000	470	330°	80x45	WLW3004X3	8031453030933	10/50	



**OLIVA WHITE FILAMENT 220-240V**

BTL CATEGORIA SCONTO 21

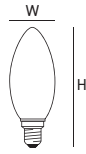

IP 20

20.000h  
2 ANNI GARANZIA

20.000



W	W=	BASE	K	lm		H x W mm	CODICE	EAN		
2,5	25	E14	3000	250	330°	97x35	WLW2002X2BB	8031453029333	10/50	
2,5	25	E14	4000	250	330°	97x35	WLW2002X3	8031453030834	10/50	
4,5	40	E14	3000	470	330°	97x35	WLW2004X2BB	8031453029340	10/50	
4,5	40	E14	4000	470	330°	97x35	WLW2004X3	8031453030841	10/50	
6,5	60	E14	3000	806	330°	97x35	WLW2008X2BB	8031453029357	10/50	
6,5	60	E14	4000	806	330°	97x35	WLW2008X3	8031453030858	10/50	



**GLOBO WHITE FILAMENT 220-240V**

BTL CATEGORIA SCONTO 21

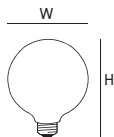

IP 20

20.000h  
2 ANNI GARANZIA

20.000



W	W=	BASE	K	lm		H x W mm	CODICE	EAN		
2,5	25	E27	3000	250	330°	178x125	WLW4002X2BB	8031453029364	5/20	
2,5	25	E27	4000	250	330°	178x125	WLW4002X3	8031453030865	5/20	
10,5	100	E27	3000	1521	330°	178x125	WLW4015X2BB	8031453029371	5/20	
10,5	100	E27	4000	1521	330°	178x125	WLW4015X3	8031453030872	5/20	



**SHOT**  
BOT LIGHTING

**LAMPADE LED STICK**  
LED STICK BULBS



**GOCCIA LED STICK CRI >95 220-240V**

BTL CATEGORIA SCONTO 21

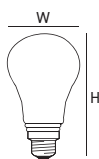

IP 20

20.000h  
2 ANNI GARANZIA

20.000



CRI > 95



W	W=	BASE	K	lm		H x W mm	CODICE	EAN		
7,5	60	E27	2700	806	330°	108x60	WLD1008X29	8031453021290	10/50	
8,0	75	E27	2700	1055	330°	108x60	WLD1010X29	8031453021306	10/50	
11,0	100	E27	2700	1521	330°	126x70	WLD1011X29	8031453021313	10/50	

**SFERA LED STICK CRI>95 220-240V**

BTL CATEGORIA SCONTO 21

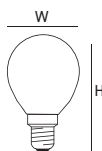

IP 20

20.000h  
2 ANNI GARANZIA

20.000



CRI > 95



W	W=	BASE	K	lm		H x W mm	CODICE	EAN		
5,0	40	E14	2700	470	330°	80x45	WLD3004X29	8031453021337	10/50	
5,0	40	E27	2700	470	330°	78x45	WLD3104X29	8031453021344	10/50	

**OLIVA LED STICK CRI >95 220-240V**

BTL CATEGORIA SCONTO 21



IP 20

20.000h  
2 ANNI GARANZIA

20.000



CRI > 95



W	W=	BASE	K	lm		H x W mm	CODICE	EAN		
5,0	40	E14	2700	470	330°	97x35	WLD2004X29	8031453021320	10/50	

**GOCCIA LED STICK DIMMERABLE 220-240V**

BTL CATEGORIA SCONTO 21

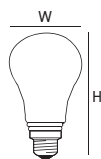

IP 20

 20.000h  
 2 ANNI GARANZIA

20.000



W	W=	BASE	K	lm		H x W mm	CODICE	EAN		
7,0	60	E27	2700	806	330°	108x60	WLD1008X2D	8031453017750	10/50	
7,0	60	E27	4000	806	330°	108x60	WLD1008X3D	8031453023980	10/50	
9,0	75	E27	2700	1055	330°	108x60	WLD1010X2D	8031453020958	10/50	
9,0	75	E27	4000	1055	330°	108x60	WLD1010X3D	8031453023997	10/50	
11,0	100	E27	2700	1521	330°	108x60	WLD1011X2D	8031453024000	10/50	
11,0	100	E27	4000	1521	330°	108x60	WLD1011X3D	8031453024017	10/50	

**SFERA LED STICK DIMMERABLE 220-240V**

BTL CATEGORIA SCONTO 21

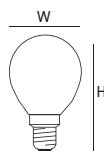

IP 20

 20.000h  
 2 ANNI GARANZIA

20.000



W	W=	BASE	K	lm		H x W mm	CODICE	EAN		
4,5	40	E14	2700	470	330°	80x45	WLD3004X2D	8031453020989	10/50	
4,5	40	E14	4000	470	330°	80x45	WLD3004X3D	8031453024024	10/50	
5,9	60	E14	2700	806	330°	80x45	WLD3006X2D	8031453027278	10/50	
6,0	60	E27	2700	806	330°	78x45	WLD3106X2D	8031453020996	10/50	
6,5	60	E27	4000	806	330°	78x45	WLD3106X3D	8031453024031	10/50	



**OLIVA LED STICK DIMMERABILE 220-240V**

BTL CATEGORIA SCONTO 21

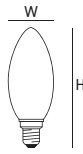

W	W=	BASE	K	lm		H x W mm	CODICE	EAN		
4,5	40	E14	2700	470	330°	97x35	WLD2004X2D	8031453019372	10/50	
4,5	40	E14	4000	470	330°	97x35	WLD2004X3D	8031453024048	10/50	
5,9	60	E14	2700	806	330°	97x35	WLD2006X2D	8031453027261	10/50	



**OLIVA LED STICK SATINATA DIMMERABILE 220-240V**

BTL CATEGORIA SCONTO 21



W	W=	BASE	K	lm		H x W mm	CODICE	EAN		
4,5	40	E14	2700	470	330°	97x35	WLD2004X2SD	8031453019389	10/50	

**GLOBO 125 LED STICK DIMMERABILE 220-240V**

BTL CATEGORIA SCONTO 21

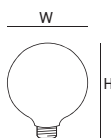

W	W=	BASE	K	lm		H x W mm	CODICE	EAN		
2,5	25	E27	2700	250	330°	178x125	WLD4002X2D	8031453017811	5/20	
7,0	60	E27	2700	806	330°	178x125	WLD4008X2D	8031453017781	5/20	
7,0	60	E27	4000	806	330°	178x125	WLD4008X3D	8031453024055	5/20	
11,0	100	E27	2700	1521	330°	178x125	WLD4013X2D	8031453020965	5/20	
11,0	100	E27	4000	1521	330°	178x125	WLD4013X3D	8031453024062	5/20	

**GLOBO 125 LED SPRING DIMMERABILE 220-240V**

BTL CATEGORIA SCONTO 21

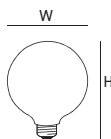

W	W=	BASE	K	lm		H x W mm	CODICE	EAN		
5,0	28	E27	1800	300	330°	178x125	WLD4005X2HSDW	8031453024659	5/20	-
5,0	35	E27	2700	400	330°	178x125	WLD4005X2HSD	8031453024642	5/20	

**TUBOLARE T38 LED STICK DIMMERABILE 220-240V**

BTL CATEGORIA SCONTO 21



W	W=	BASE	K	lm		H x W mm	CODICE	EAN		
14,0	145	E27	3000	2350	330°	150x38	WLD7814X2BBD	8031453032739	10/50	



## GOCCIA LED STICK 220-240V

BTL CATEGORIA SCONTO 21

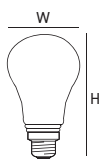

IP 20

20.000h  
2 ANNI GARANZIA

20.000



W	W=	BASE	K	lm		H x W mm	CODICE	EAN		
4,5	40	E27	2700	470	330°	108x60	WLD1004X2	8031453008086	10/50	
7,0	60	E27	2700	806	330°	108x60	WLD1008X2	8031453011918	10/50	
7,0	60	E27	3000	806	330°	108x60	WLD1008X2BB	8031453027926	10/50	
7,0	60	E27	4000	806	330°	108x60	WLD1008X3	8031453017026	10/50	
7,0	60	E27	6500	806	330°	108x60	WLD1008X1	8031453016999	10/50	
8,5	75	E27	2700	1055	330°	108x60	WLD1010X2	8031453014599	10/50	
8,5	75	E27	3000	1055	330°	108x60	WLD1010X2BB	8031453027933	10/50	
8,5	75	E27	4000	1055	330°	108x60	WLD1010X3	8031453016937	10/50	
8,5	75	E27	6500	1055	330°	108x60	WLD1010X1	8031453016968	10/50	
10,5	100	E27	2700	1521	330°	108x60	WLD1011X2	8031453016609	10/50	
10,5	100	E27	3000	1521	330°	108x60	WLD1011X2BB	8031453027940	10/50	
10,5	100	E27	4000	1521	330°	108x60	WLD1011X3	8031453016876	10/50	
10,5	100	E27	6500	1521	330°	108x60	WLD1011X1	8031453016906	10/50	
18,0	150	E27	2700	2452	330°	126x70	WLD1016X2	8031453021436	10/50	
18,0	150	E27	4000	2452	330°	126x70	WLD1016X3	8031453021443	10/50	
18,0	150	E27	6500	2452	330°	126x70	WLD1016X1	8031453021429	10/50	

**SFERA LED STICK 220-240V**

BTL CATEGORIA SCONTO 21

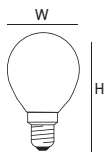

IP 20

 20.000h  
 2 ANNI GARANZIA

20.000



W	W=	BASE	K	lm		H x W mm	CODICE	EAN		
1,4	15	E14	2700	136	330°	80x45	WLD3001X2	8031453027407	10/50	
2,5	25	E14	2700	250	330°	80x45	WLD3002X2	8031453008413	10/50	
4,5	40	E14	2700	470	330°	80x45	WLD3004X2	8031453008444	10/50	
4,5	40	E14	3000	470	330°	80x45	WLD3004X2BB	8031453027988	10/50	
4,5	40	E14	4000	470	330°	80x45	WLD3004X3	8031453016746	10/50	
4,5	40	E14	6500	470	330°	80x45	WLD3004X1	8031453016777	10/50	
6,5	60	E14	2700	806	330°	80x45	WLD3006X2	8031453021184	10/50	
6,5	60	E14	3000	806	330°	80x45	WLD3006X2BB	8031453027995	10/50	
6,5	60	E14	4000	806	330°	80x45	WLD3006X3	8031453021191	10/50	
7,0	75	E14	2700	1055	330°	80x45	WLD3007X2	8031453028114	10/50	
7,0	75	E14	3000	1055	330°	80x45	WLD3007X2BB	8031453028121	10/50	
7,0	75	E14	4000	1055	330°	80x45	WLD3007X3	8031453028138	10/50	
1,4	15	E27	2700	136	330°	78x45	WLD3101X2	8031453027414	10/50	
2,5	25	E27	2700	250	330°	78x45	WLD3102X2	8031453027421	10/50	
4,5	40	E27	2700	470	330°	78x45	WLD3104X2	8031453016630	10/50	
4,5	40	E27	3000	470	330°	78x45	WLD3104X2BB	8031453028008	10/50	
4,5	40	E27	4000	470	330°	78x45	WLD3104X3	8031453016685	10/50	
4,5	40	E27	6500	470	330°	78x45	WLD3104X1	8031453016715	10/50	
6,5	60	E27	2700	806	330°	78x45	WLD3106X2	8031453021207	10/50	
6,5	60	E27	3000	806	330°	78x45	WLD3106X2BB	8031453028015	10/50	
6,5	60	E27	4000	806	330°	78x45	WLD3106X3	8031453021252	10/50	
7,0	75	E27	2700	1055	330°	78x45	WLD3107X2	8031453028145	10/50	
7,0	75	E27	3000	1055	330°	78x45	WLD3107X2BB	8031453028152	10/50	
7,0	75	E27	4000	1055	330°	78x45	WLD3107X3	8031453028169	10/50	

**OLIVA LED STICK 220-240V**

BTL CATEGORIA SCONTO 21

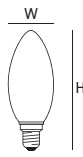

IP 20

20.000h  
2 ANNI GARANZIA

20.000



W	W=	BASE	K	lm		H x W mm	CODICE	EAN		
2,5	25	E14	2700	250	330°	97x35	WLD2002X2	8031453008352	10/50	
2,5	25	E14	3000	250	330°	97x35	WLD2002X2BB	8031453027957	10/50	
2,5	25	E14	4000	250	330°	97x35	WLD2002X3	8031453019327	10/50	
4,5	40	E14	2700	470	330°	97x35	WLD2004X2	8031453008383	10/50	
4,5	40	E14	3000	470	330°	97x35	WLD2004X2BB	8031453027964	10/50	
4,5	40	E14	4000	470	330°	97x35	WLD2004X3	8031453016814	10/50	
4,5	40	E14	6500	470	330°	97x35	WLD2004X1	8031453016845	10/50	
6,5	60	E14	2700	806	330°	97x35	WLD2006X2	8031453021160	10/50	
6,5	60	E14	3000	806	330°	97x35	WLD2006X2BB	8031453027971	10/50	
6,5	60	E14	4000	806	330°	97x35	WLD2006X3	8031453021177	10/50	
7,0	75	E14	2700	1055	330°	97x35	WLD2007X2	8031453028084	10/50	
7,0	75	E14	3000	1055	330°	97x35	WLD2007X2BB	8031453028091	10/50	
7,0	75	E14	4000	1055	330°	97x35	WLD2007X3	8031453028107	10/50	

**TORTIGLIONE LED STICK 220-240V**

BTL CATEGORIA SCONTO 21



IP 20

20.000h  
2 ANNI GARANZIA

20.000



W	W=	BASE	K	lm		H x W mm	CODICE	EAN		
2,5	25	E14	2700	250	330°	97x35	WLD2002T2	8031453025229	10/50	
4,5	40	E14	2700	470	330°	97x35	WLD2004T2	8031453023393	10/50	
4,5	40	E14	4000	470	330°	97x35	WLD2004T3	8031453023409	10/50	

**FIAMMA LED STICK 220-240V**

BTL CATEGORIA SCONTO 21



IP 20

20.000h  
2 ANNI GARANZIA

20.000



W	W=	BASE	K	lm		H x W mm	CODICE	EAN		
4,5	40	E14	2700	470	330°	123x35	<b>WLD2004F2</b>	8031453023379	10/50	
4,5	40	E14	4000	470	330°	123x35	<b>WLD2004F3</b>	8031453023386	10/50	



**GLOBO 95 LED STICK 220-240V**

BTL CATEGORIA SCONTO 21

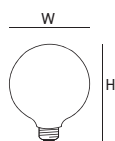

W	W=	BASE	K	lm		H x W mm	CODICE	EAN		
7,0	60	E27	2700	806	330°	140x95	<b>WLD4208X2</b>	8031453019983	5/20	
8,5	75	E27	2700	1055	330°	140x95	<b>WLD4210X2</b>	8031453019990	5/20	
8,5	75	E27	4000	1055	330°	140x95	<b>WLD4210X3</b>	8031453027650	5/20	
10,5	100	E27	2700	1521	330°	140x95	<b>WLD4215X2</b>	8031453033453	5/20	



**GLOBO 125 LED STICK 220-240V**

BTL CATEGORIA SCONTO 21

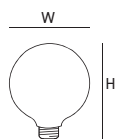

W	W=	BASE	K	lm		H x W mm	CODICE	EAN		
2,5	25	E27	2700	250	330°	178x125	<b>WLD4002X2</b>	8031453008147	5/20	
4,5	40	E27	2700	470	330°	178x125	<b>WLD4004X2</b>	8031453008178	5/20	
7,0	60	E27	2700	806	330°	178x125	<b>WLD4008X2</b>	8031453014650	5/20	
8,5	75	E27	2700	1055	330°	178x125	<b>WLD4010X2</b>	8031453011369	5/20	
8,5	75	E27	4000	1055	330°	178x125	<b>WLD4010X3</b>	8031453019402	5/20	
11,0	100	E27	2700	1521	330°	178x125	<b>WLD4011X2</b>	8031453019792	5/20	
11,0	100	E27	4000	1521	330°	178x125	<b>WLD4011X3</b>	8031453019808	5/20	

## PICCOLA PERA LED STICK 220-240V

BTL CATEGORIA SCONTO 21

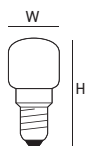

IP 20

20.000h  
2 ANNI GARANZIA

20.000



W	W=	BASE	K	lm		H x W mm	CODICE	EAN		
1,5	15	E14	2700	140	330°	56x20	WLD7301X2	8031453024277	10/50	
1,5	15	E14	4000	140	330°	56x20	WLD7301X3	8031453024284	10/50	
1,5	15	E14	6500	140	330°	56x20	WLD7301X1	8031453024260	10/50	
2,5	25	E14	2700	250	330°	61x26	WLD7102X2	8031453020378	10/50	

## TUBOLARE T20 LED STICK 220-240V

BTL CATEGORIA SCONTO 21

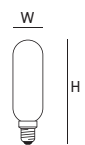

IP 20

20.000h  
2 ANNI GARANZIA

20.000



W	W=	BASE	K	lm		H x W mm	CODICE	EAN		
4,5	40	E14	2700	470	330°	90x20	WLD7204X2	8031453020385	10/50	
4,5	40	E14	4000	470	330°	90x20	WLD7204X3	8031453025328	10/50	



**TUBOLARE T25 LED STICK 220-240V**

BTL CATEGORIA SCONTO 21



IP 20

20.000h  
2 ANNI GARANZIA

20.000



W	W=	BASE	K	lm		H x W mm	CODICE	EAN		
4,5	40	E14	2700	470	330°	90x25	WLD7604X2	8031453017729	10/50	
4,5	40	E14	4000	470	330°	90x25	WLD7604X3	8031453025335	10/50	
6,5	60	E14	2700	806	330°	90x25	WLD7606X2	8031453027339	10/50	
6,5	60	E14	4000	806	330°	90x25	WLD7606X3	8031453027346	10/50	



**TUBOLARE T32 LED STICK 220-240V**

BTL CATEGORIA SCONTO 21



IP 20

20.000h  
2 ANNI GARANZIA

20.000



W	W=	BASE	K	lm		H x W mm	CODICE	EAN		
8,5	75	E27	3000	1055	330°	106x32	WLD7708X2BB	8031453028879	10/50	
8,5	75	E27	4000	1055	330°	106x32	WLD7708X3	8031453028886	10/50	

**SHOT**  
BOT LIGHTING

**LAMPADE LED STICK SATINATE**  
FROSTED LED STICK BULBS





## GOCCIA LED STICK SATINATA 220-240V

BTL CATEGORIA SCONTO 21

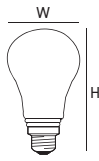

IP 20

20.000h  
2 ANNI GARANZIA

20.000



W	W=	BASE	K	lm		H x W mm	CODICE	EAN		
7,0	60	E27	2700	806	330°	108x60	WLD1008X2S	8031453014629	10/50	
7,0	60	E27	4000	806	330°	108x60	WLD1008X3S	8031453024079	10/50	
8,5	75	E27	2700	1055	330°	108x60	WLD1010X2S	8031453024086	10/50	
8,5	75	E27	4000	1055	330°	108x60	WLD1010X3S	8031453024093	10/50	



## SFERA LED STICK SATINATA 220-240V

BTL CATEGORIA SCONTO 21

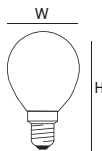

IP 20

20.000h  
2 ANNI GARANZIA

20.000



W	W=	BASE	K	lm		H x W mm	CODICE	EAN		
2,5	25	E14	2700	250	330°	80x45	WLD3002X2S	8031453009076	10/50	
4,5	40	E14	2700	470	330°	80x45	WLD3004X2S	8031453009106	10/50	
4,5	40	E14	4000	470	330°	80x45	WLD3004X3S	8031453019365	10/50	
4,5	40	E27	2700	470	330°	78x45	WLD3104X2S	8031453011949	10/50	

**OLIVA LED STICK SATINATA 220-240V**

BTL CATEGORIA SCONTO 21

**IP 20**

 20.000h  
 2 ANNI GARANZIA

20.000



W	W=	BASE	K	lm		H x W mm	CODICE	EAN		
2,5	25	E14	2700	250	330°	97x35	<b>WLD2002X2S</b>	8031453009014	10/50	
4,5	40	E14	2700	470	330°	97x35	<b>WLD2004X2S</b>	8031453009045	10/50	
4,5	40	E14	4000	470	330°	97x35	<b>WLD2004X3S</b>	8031453019334	10/50	
6,5	60	E14	2700	806	330°	97x35	<b>WLD2006X2S</b>	8031453024109	10/50	
6,5	60	E14	4000	806	330°	97x35	<b>WLD2006X3S</b>	8031453024116	10/50	

**TORTIGLIONE LED STICK SATINATA 220-240V**

BTL CATEGORIA SCONTO 21

**IP 20**

 20.000h  
 2 ANNI GARANZIA

20.000



W	W=	BASE	K	lm		H x W mm	CODICE	EAN		
2,5	25	E14	2700	250	330°	97x35	<b>WLD2002T2S</b>	8031453025212	10/50	
4,5	40	E14	2700	470	330°	97x35	<b>WLD2004T2S</b>	8031453011338	10/50	
4,5	40	E14	4000	470	330°	97x35	<b>WLD2004T3S</b>	8031453019358	10/50	
6,5	60	E14	2700	806	330°	97x35	<b>WLD2006T2S</b>	8031453024123	10/50	
6,5	60	E14	4000	806	330°	97x35	<b>WLD2006T3S</b>	8031453024147	10/50	

**FIAMMA LED STICK SATINATA 220-240V**

BTL CATEGORIA SCONTO 21

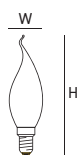

IP 20

20.000h  
2 ANNI GARANZIA

20.000



W	W=	BASE	K	lm		H x W mm	CODICE	EAN		
4,5	40	E14	2700	470	330°	123x35	WLD2004F2S	8031453011307	10/50	
4,5	40	E14	4000	470	330°	123x35	WLD2004F3S	8031453019341	10/50	
6,5	60	E14	2700	806	330°	123x35	WLD2006F2S	8031453024130	10/50	
6,5	60	E14	4000	806	330°	123x35	WLD2006F3S	8031453024154	10/50	

**GLOBO 125 LED STICK SATINATA 220-240V**

BTL CATEGORIA SCONTO 21

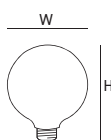

IP 20

20.000h  
2 ANNI GARANZIA

20.000



W	W=	BASE	K	lm		H x W mm	CODICE	EAN		
8,5	75	E27	2700	1055	330°	178x125	WLD4010X2S	8031453012236	5/20	

**REFLECTOR R39 LED STICK SATINATA 220-240V**

BTL CATEGORIA SCONTO 21

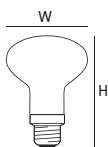

IP 20

20.000h  
2 ANNI GARANZIA

20.000



W	W=	BASE	K	lm		H x W mm	CODICE	EAN		
2,5	14	E14	2700	125	110°	67x39	WLD500252	8031453019815	10/50	



**REFLECTOR R50 LED STICK SATINATA 220-240V**

BTL CATEGORIA SCONTO 21

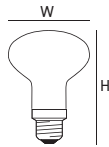

IP 20

20.000h  
2 ANNI GARANZIA

20.000



W	W=	BASE	K	lm		H x W mm	CODICE	EAN		
4,0	30	E14	2700	330	120°	85x50	WLD500452	8031453019822	10/50	



**REFLECTOR R63 LED STICK SATINATA 220-240V**

BTL CATEGORIA SCONTO 21

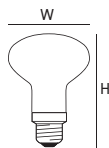

IP 20

20.000h  
2 ANNI GARANZIA

20.000



W	W=	BASE	K	lm		H x W mm	CODICE	EAN		
7,0	60	E27	2700	806	110°	102x63	WLD500752	8031453024383	10/50	



**REFLECTOR R80 LED STICK SATINATA 220-240V**

BTL CATEGORIA SCONTO 21

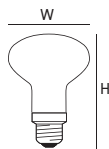

IP 20

20.000h  
2 ANNI GARANZIA

20.000



W	W=	BASE	K	lm		H x W mm	CODICE	EAN		
4,5	40	E27	2700	470	80°	116x80	WLD500652	8031453014353	10/50	
7,0	60	E27	2700	806	80°	114x80	WLD500852	8031453024390	10/50	



## REFLECTOR R125 LED STICK SATINATA DIMMERABILE 220-240V

AGGIORNATO

BTL CATEGORIA SCONTO 21

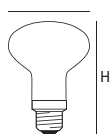

IP 20

20.000h  
2 ANNI GARANZIA

20.000



W	W=	BASE	K	lm		H x W mm	CODICE	EAN			
11,0	75	E27	2700	1055	120°	180x125	WLD501152D	8031453022532	5/20		
13,0	-	E27	2700	1350	120°	180x125	WLD501352D	8031453035907	5/20		

NEW



## GOCCIA LED STICK CUPOLA ARGENTATA 220-240V

BTL CATEGORIA SCONTO 21

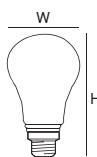

IP 20

20.000h  
2 ANNI GARANZIA

20.000



W	W=	BASE	K	lm		H x W mm	CODICE	EAN			
7,0	53	E27	2700	680	280°	108x60	WLD1008X2CA	8031453014018	10/50		



## SFERA LED STICK CUPOLA ARGENTATA 220-240V

BTL CATEGORIA SCONTO 21

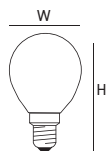

IP 20

20.000h  
2 ANNI GARANZIA

20.000



W	W=	BASE	K	lm		H x W mm	CODICE	EAN			
4,5	35	E14	2700	400	270°	80x45	WLD3005X2CA	8031453014049	10/50		

**GOCCIA LED STICK CON SENSORE CREPUSCOLARE 220-240V**

BTL CATEGORIA SCONTO 21

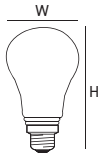

\_ Sensore crepuscolare integrato nella virola    \_ *Dusk sensor integrated in the body*

IP 20
20.000h  
2 ANNI GARANZIA
20.000

 AUTOMATIC ON-OFF

W	W=	BASE	K	lm	lm		H x W mm	CODICE	EAN		
7,8	75	E27	2700	1055	1055	330°	108x60	WLDSENS10X2	8031453026110	10/50	

**SHOT**  
BOT LIGHTING

**LAMPADE FULL LIGHT**  
FULL LIGHT BULBS



**GOCCIA FULL LIGHT - Classe B 220-240V**

**NEW**

BTL CATEGORIA SCONTO 21

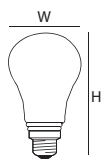

IP 20

20.000h  
2 ANNI GARANZIA

20.000



W	W=	BASE	K	lm		H x W mm	CODICE	EAN		
13,0	150	E27	2700	2452	330°	108x60	<b>MLH1016X2</b>	8031453035327	10/50	
13,0	150	E27	4000	2452	330°	108x60	<b>MLH1016X3</b>	8031453035334	10/50	



**GOCCIA FULL LIGHT 220-240V**

BTL CATEGORIA SCONTO 21

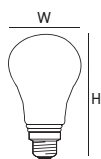

IP 20

20.000h  
2 ANNI GARANZIA

20.000



W	W=	BASE	K	lm		H x W mm	CODICE	EAN		
7,0	60	E27	2700	806	330°	108x60	<b>MLD1008X2</b>	8031453018900	10/50	
7,0	60	E27	4000	806	330°	108x60	<b>MLD1008X3</b>	8031453021610	10/50	
8,5	75	E27	2700	1055	330°	108x60	<b>MLD1010X2</b>	8031453018917	10/50	
8,5	75	E27	4000	1055	330°	108x60	<b>MLD1010X3</b>	8031453021627	10/50	
10,5	100	E27	2700	1521	330°	108x60	<b>MLD1011X2</b>	8031453018924	10/50	
10,5	100	E27	4000	1521	330°	108x60	<b>MLD1011X3</b>	8031453021634	10/50	
18,0	150	E27	2700	2452	330°	126x70	<b>MLD1016X2</b>	8031453021412	10/50	
18,0	150	E27	4000	2452	330°	126x70	<b>MLD1016X3</b>	8031453021641	10/50	
22,0	200	E27	2700	3452	330°	162x95	<b>MLD1022X2</b>	8031453028510	5/20	
22,0	200	E27	4000	3452	330°	162x95	<b>MLD1022X3</b>	8031453028527	5/20	

SFERA FULL LIGHT 220-240V **AGGIORNATO**

BTL CATEGORIA SCONTO 21

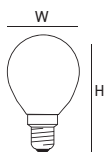

IP 20

20.000h  
2 ANNI GARANZIA

20.000



W	W=	BASE	K	lm		H x W mm	CODICE	EAN				
2,5	25	E14		2700	250	330°	80x45	<b>MLD3002X2</b>	8031453035297	10/50		<b>NEW</b>
4,5	40	E14		2700	470	330°	80x45	<b>MLD3004X2</b>	8031453018948	10/50		
4,5	40	E14		4000	470	330°	80x45	<b>MLD3004X3</b>	8031453021696	10/50		
6,5	60	E14		2700	806	330°	80x45	<b>MLD3006X2</b>	8031453021276	10/50		
6,5	60	E14		4000	806	330°	80x45	<b>MLD3006X3</b>	8031453021702	10/50		
7,0	75	E14		2700	1055	330°	80x45	<b>MLD3007X2</b>	8031453028190	10/50		
7,0	75	E14		4000	1055	330°	80x45	<b>MLD3007X3</b>	8031453028206	10/50		
2,5	25	E27		2700	250	330°	78x45	<b>MLD3102X2</b>	8031453035303	10/50		<b>NEW</b>
4,5	40	E27		2700	470	330°	78x45	<b>MLD3104X2</b>	8031453018955	10/50		
4,5	40	E27		4000	470	330°	78x45	<b>MLD3104X3</b>	8031453021672	10/50		
6,5	60	E27		2700	806	330°	78x45	<b>MLD3106X2</b>	8031453021283	10/50		
6,5	60	E27		4000	806	330°	78x45	<b>MLD3106X3</b>	8031453021689	10/50		
7,0	75	E27		2700	1055	330°	78x45	<b>MLD3107X2</b>	8031453028213	10/50		
7,0	75	E27		4000	1055	330°	78x45	<b>MLD3107X3</b>	8031453028220	10/50		

**OLIVA FULL LIGHT 220-240V** AGGIORNATO

BTL CATEGORIA SCONTO 21



IP 20

20.000h  
2 ANNI GARANZIA

20.000



	W	W=	BASE	K	lm		H x W mm	CODICE	EAN		
<b>NEW</b>	2,5	25	E14	2700	250	330°	97x35	<b>MLD2002X2</b>	8031453035280	10/50	
	4,5	40	E14	2700	470	330°	97x35	<b>MLD2004X2</b>	8031453018931	10/50	
	4,5	40	E14	4000	470	330°	97x35	<b>MLD2004X3</b>	8031453021658	10/50	
	6,5	60	E14	2700	806	330°	97x35	<b>MLD2006X2</b>	8031453021269	10/50	
	6,5	60	E14	4000	806	330°	97x35	<b>MLD2006X3</b>	8031453021665	10/50	
	7,0	75	E14	2700	1055	330°	97x35	<b>MLD2007X2</b>	8031453028176	10/50	
	7,0	75	E14	4000	1055	330°	97x35	<b>MLD2007X3</b>	8031453028183	10/50	

**TORTIGLIONE FULL LIGHT 220-240V**

BTL CATEGORIA SCONTO 21



IP 20

20.000h  
2 ANNI GARANZIA

20.000



	W	W=	BASE	K	lm		H x W mm	CODICE	EAN		
	4,5	40	E14	2700	470	330°	97x35	<b>MLD2004T2</b>	8031453023119	10/50	
	6,5	60	E14	2700	806	330°	97x35	<b>MLD2006T2</b>	8031453023126	10/50	

**FIAMMA FULL LIGHT 220-240V**

BTL CATEGORIA SCONTO 21

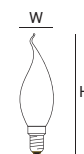

IP 20

20.000h  
2 ANNI GARANZIA

20.000



	W	W=	BASE	K	lm		H x W mm	CODICE	EAN		
	4,5	40	E14	2700	470	330°	123x35	<b>MLD2004F2</b>	8031453023096	10/50	
	6,5	60	E14	2700	806	330°	123x35	<b>MLD2006F2</b>	8031453023102	10/50	



**GLOBO 95 FULL LIGHT 220-240V** AGGIORNATO

BTL CATEGORIA SCONTO 21

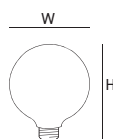

W	W=	BASE	K	lm		H x W mm	CODICE	EAN			
7,0	60	E27	2700	806	330°	140x95	<b>MLD4208X2</b>	8031453018979	5/20		
8,5	75	E27	2700	1055	330°	140x95	<b>MLD4210X2</b>	8031453035310	5/20		<b>NEW</b>
10,5	100	E27	2700	1521	330°	140x95	<b>MLD4215X2</b>	8031453033446	5/20		



**GLOBO 125 FULL LIGHT 220-240V**

BTL CATEGORIA SCONTO 21

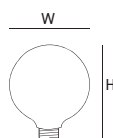

W	W=	BASE	K	lm		H x W mm	CODICE	EAN			
7,0	60	E27	2700	806	330°	178x125	<b>MLD4008X2</b>	8031453018962	5/20		
8,5	75	E27	2700	1055	330°	178x125	<b>MLD4010X2</b>	8031453019495	5/20		
11,0	100	E27	2700	1521	330°	178x125	<b>MLD4011X2</b>	8031453019785	5/20		
11,0	100	E27	4000	1521	330°	178x125	<b>MLD4011X3</b>	8031453021719	5/20		
18,0	150	E27	2700	2452	330°	178x125	<b>MLD4016X2</b>	8031453024246	5/20		
18,0	150	E27	4000	2452	330°	178x125	<b>MLD4016X3</b>	8031453024253	5/20		
21,5	200	E27	2700	3452	330°	178x125	<b>MLD4022X2</b>	8031453026394	5/20		



### GOCCIA FULL LIGHT DIMMERABILE 220-240V

BTL CATEGORIA SCONTO 21

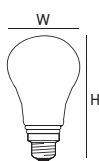

IP 20

20.000h  
2 ANNI GARANZIA

20.000



W	W=	BASE	K	lm		H x W mm	CODICE	EAN		
7,0	60	E27	2700	806	330°	108x60	<b>MLD1008X2D</b>	8031453020941	10/50	
11,0	100	E27	2700	1521	330°	108x60	<b>MLD1011X2D</b>	8031453023966	10/50	



### SFERA FULL LIGHT DIMMERABILE 220-240V

BTL CATEGORIA SCONTO 21

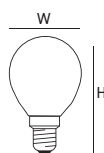

IP 20

20.000h  
2 ANNI GARANZIA

20.000



W	W=	BASE	K	lm		H x W mm	CODICE	EAN		
4,5	40	E14	2700	470	330°	80x45	<b>MLD3004X2D</b>	8031453023973	10/50	
5,9	60	E14	2700	806	330°	80x45	<b>MLD3006X2D</b>	8031453027292	10/50	



### OLIVA FULL LIGHT DIMMERABILE 220-240V

BTL CATEGORIA SCONTO 21



IP 20

20.000h  
2 ANNI GARANZIA

20.000



W	W=	BASE	K	lm		H x W mm	CODICE	EAN		
4,5	40	E14	2700	470	330°	97x35	<b>MLD2004X2D</b>	8031453021214	10/50	
5,9	60	E14	2700	806	330°	97x35	<b>MLD2006X2D</b>	8031453027285	10/50	



**GLOBO 125 FULL LIGHT DIMMERABILE 220-240V**

BTL CATEGORIA SCONTO 21

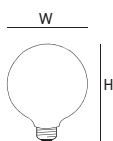

W	W=	BASE	K	lm		H x W mm	CODICE	EAN		
11.0	100	E27	2700	1521	330°	178x125	MLD4013X2D	8031453020972	5/20	D



**TUBOLARE T38 FULL LIGHT DIMMERABILE 220-240V**

BTL CATEGORIA SCONTO 21



W	W=	BASE	K	lm		H x W mm	CODICE	EAN		
14.0	120	E27	2700	1900	330°	150x38	MLD7814X2D	8031453032722	10/50	D

**SHOT**  
BOT LIGHTING

**LAMPADE VINTAGE**  
VINTAGE BULBS







**EDISON LED STICK GOLD 220-240V**

BTL CATEGORIA SCONTO 21

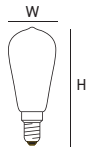

IP 20

20.000h  
2 ANNI GARANZIA

20.000



W	W=	BASE	K	lm		H x W mm	CODICE	EAN		
7,0	55	E27	2500	725	330°	133x58	WLD7508X2G	8031453020453	10/50	



**GOCCIA LED STICK GOLD 220-240V**

BTL CATEGORIA SCONTO 21

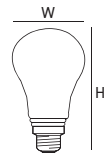

IP 20

20.000h  
2 ANNI GARANZIA

20.000



W	W=	BASE	K	lm		H x W mm	CODICE	EAN		
7,0	55	E27	2500	725	330°	108x60	WLD1008X2G	8031453020408	10/50	



**OLIVA LED STICK GOLD 220-240V**

BTL CATEGORIA SCONTO 21

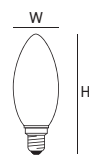

IP 20

20.000h  
2 ANNI GARANZIA

20.000



W	W=	BASE	K	lm		H x W mm	CODICE	EAN		
4,5	37	E14	2500	420	330°	97x35	WLD2004X2G	8031453020422	10/50	



**TORTIGLIONE LED STICK GOLD 220-240V**

BTL CATEGORIA SCONTO 21



IP 20

15.000h  
2 ANNI GARANZIA

15.000



W	W=	BASE	K	lm		H x W mm	CODICE	EAN		
4,5	37	E14	2500	420	330°	97x35	WLD2004T2G	8031453020415	10/50	



**GLOBO 95 LED STICK GOLD 220-240V**

BTL CATEGORIA SCONTO 21

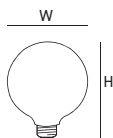

IP 20

15.000h  
2 ANNI GARANZIA

15.000



W	W=	BASE	K	lm		H x W mm	CODICE	EAN		
7,0	55	E27	2500	725	330°	140x95	WLD4208X2G	8031453020439	5/20	



**GLOBO 125 LED STICK GOLD 220-240V**

BTL CATEGORIA SCONTO 21

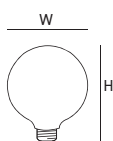

IP 20

20.000h  
2 ANNI GARANZIA

20.000



W	W=	BASE	K	lm		H x W mm	CODICE	EAN		
7,0	55	E27	2500	725	330°	178x125	WLD4008X2G	8031453020446	5/20	



**GOCCIA F.O.B. STICK DIMMERABLE 220-240V**

BTL CATEGORIA SCONTO 21

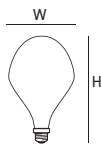

IP 20

25.000h  
3 ANNI GARANZIA

20.000



W	W=	BASE	K	lm		H x W mm	CODICE	EAN		
8,0	-	E27	2000	500	330°	298x160	WLD6108X2AM	8031453021016	1/6	-



**GLOBO F.O.B. STICK DIMMERABLE 220-240V**

BTL CATEGORIA SCONTO 21

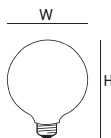

IP 20

25.000h  
3 ANNI GARANZIA

20.000



W	W=	BASE	K	lm		H x W mm	CODICE	EAN		
8,0	-	E27	2000	500	330°	300x200	WLD6008X2AM	8031453021009	1/4	-



**BT F.O.B. STICK DIMMERABLE 220-240V**

BTL CATEGORIA SCONTO 21

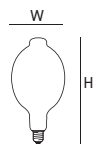

IP 20

25.000h  
3 ANNI GARANZIA

20.000



W	W=	BASE	K	lm		H x W mm	CODICE	EAN		
8,0	-	E27	2000	500	330°	380x180	WLD6208X2AM	8031453021023	1/6	-

**ALVEARE F.O.B. STICK DIMMERABILE 220-240V**

BTL CATEGORIA SCONTO 21



IP 20

25.000h  
3 ANNI GARANZIA

20.000



W	W=	BASE	K	lm		H x W mm	CODICE	EAN		
8,0	-	E27	2000	500	330°	390x200	WLD6308X2AM	8031453021351	1/4	-

**UFO F.O.B. STICK DIMMERABILE 220-240V**

BTL CATEGORIA SCONTO 21



IP 20

25.000h  
3 ANNI GARANZIA

20.000



W	W=	BASE	K	lm		H x W mm	CODICE	EAN		
8,0	-	E27	2000	500	330°	265x220	WLD6408X2AM	8031453021368	1/4	-

**LANTERNA F.O.B. STICK DIMMERABILE 220-240V**

BTL CATEGORIA SCONTO 21



IP 20

25.000h  
3 ANNI GARANZIA

20.000



W	W=	BASE	K	lm		H x W mm	CODICE	EAN		
8,0	-	E27	2000	500	330°	250x140	WLD6508X2AM	8031453021375	1/6	-
8,0	-	E27	2000	250	330°	250x140	WLD6508X2SK	8031453021382	1/6	-

**SHOT**  
BOT LIGHTING

**LAMPADE SMD**  
SMD LIGHT BULBS





**GOCCIA OPALE A60 220-240V AGGIORNATO**

BTL CATEGORIA SCONTO 21

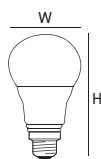
**IP 20**

 15.000h  
 2 ANNI GARANZIA

50.000



W	W=	BASE	K	lm		H x W mm	CODICE	EAN		
4,9	40	E27	2700	470	200°	106x60	<b>ELD1007X2</b>	8031453008505	10/100	
4,9	40	E27	6500	470	200°	106x60	<b>ELD1007X1</b>	8031453008475	10/100	
8,5	60	E27	2700	806	200°	106x60	<b>ELD1009X2</b>	8031453009823	10/100	
8,5	60	E27	3000	806	200°	106x60	<b>ELD1009X2BB</b>	8031453020064	10/100	
8,5	60	E27	4000	806	200°	106x60	<b>ELD1009X3</b>	8031453017057	10/100	
8,5	60	E27	6500	806	200°	106x60	<b>ELD1009X1</b>	8031453009793	10/100	
9,5	75	E27	2700	1055	150°	109x60	<b>ELD1012X2</b>	8031453009885	10/100	
9,5	75	E27	3000	1055	150°	109x60	<b>ELD1012X2BB</b>	8031453020071	10/100	
9,5	75	E27	4000	1055	150°	109x60	<b>ELD1012X3</b>	8031453017088	10/100	
9,5	75	E27	6500	1055	150°	109x60	<b>ELD1012X1</b>	8031453009854	10/100	
13,0	100	E27	2700	1521	150°	118x60	<b>ELD1015X2</b>	8031453014995	10/100	
13,0	100	E27	3000	1521	150°	118x60	<b>ELD1015X2BB</b>	8031453020088	10/100	
13,0	100	E27	4000	1521	150°	118x60	<b>ELD1015X3</b>	8031453017118	10/100	
13,0	100	E27	6500	1521	150°	118x60	<b>ELD1015X1</b>	8031453014964	10/100	
14,0	120	E27	2700	1901	180°	120x60	<b>ELD1016X2B</b>	8031453028435	10/50	
14,0	120	E27	3000	1901	180°	120x60	<b>ELD1016X2BB</b>	8031453028442	10/50	
14,0	120	E27	4000	1901	180°	120x60	<b>ELD1016X3B</b>	8031453028459	10/50	
14,0	120	E27	6500	1901	180°	120x60	<b>ELD1016X1B</b>	8031453028428	10/50	



### GOCCIA OPALE A67 220-240V

BTL CATEGORIA SCONTO 21

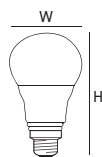

IP 20

15.000h  
2 ANNI GARANZIA

40.000



W	W=	BASE	K	lm		H x W mm	CODICE	EAN		
17,5	150	E27	2700	2452	200°	143x67	ELD1020X2	8031453018184	10/50	
17,5	150	E27	4000	2452	200°	143x67	ELD1020X3	8031453018436	10/50	
17,5	150	E27	6500	2452	200°	143x67	ELD1020X1	8031453018153	10/50	



### GOCCIA OPALE A80 220-240V

BTL CATEGORIA SCONTO 21

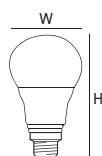

IP 20

15.000h  
2 ANNI GARANZIA

40.000



W	W=	BASE	K	lm		H x W mm	CODICE	EAN		
23,5	190	E27	2700	3400	200°	155x80	ELD1025X2	8031453023195	20	
23,5	190	E27	4000	3400	200°	155x80	ELD1025X3	8031453023201	20	
23,5	190	E27	6500	3400	200°	155x80	ELD1025X1	8031453023188	20	

**SFERA OPALE E27 220-240V**

BTL CATEGORIA SCONTO 21

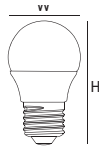
**IP 20**

 15.000h  
 2 ANNI GARANZIA

40.000



W	W=	BASE	K	lm		H x W mm	CODICE	EAN		
2,7	25	E27	2700	250	200°	74x45	<b>ELD3103X2</b>	8031453018764	10/100	
2,7	25	E27	4000	250	200°	74x45	<b>ELD3103X3</b>	8031453018771	10/100	
3,0	25	E27	6500	250	200°	74x45	<b>ELD3103X1</b>	8031453018757	10/100	
4,9	40	E27	2700	470	240°	74x45	<b>ELD3106X2</b>	8031453010485	10/100	
4,9	40	E27	3000	470	240°	74x45	<b>ELD3106X2BB</b>	8031453020118	10/100	
4,9	40	E27	4000	470	240°	74x45	<b>ELD3106X3</b>	8031453017200	10/100	
4,9	40	E27	6500	470	240°	74x45	<b>ELD3106X1</b>	8031453010454	10/100	
7,2	60	E27	2700	806	220°	84x45	<b>ELD3110X2</b>	8031453019136	10/100	
7,2	60	E27	3000	806	220°	84x45	<b>ELD3110X2BB</b>	8031453020125	10/100	
7,2	60	E27	4000	806	220°	84x45	<b>ELD3110X3</b>	8031453019143	10/100	
7,2	60	E27	6500	806	220°	84x45	<b>ELD3110X1</b>	8031453019129	10/100	
6,5	75	E27	2700	1055	150°	77x45	<b>ELD3111X2</b>	8031453033217	10/100	
6,5	75	E27	3000	1055	150°	77x45	<b>ELD3111X2BB</b>	8031453033224	10/100	
6,5	75	E27	4000	1055	150°	77x45	<b>ELD3111X3</b>	8031453033231	10/100	
6,5	75	E27	6500	1055	150°	77x45	<b>ELD3111X1</b>	8031453033200	10/100	



## SFERA OPALE E14 220-240V

BTL CATEGORIA SCONTO 21

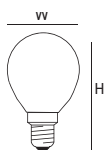

IP 20

15.000h  
2 ANNI GARANZIA

40.000



W	W=	BASE	K	lm		H x W mm	CODICE	EAN		
2,7	25	E14	2700	250	200°	78x45	<b>ELD3003X2</b>	8031453010065	10/100	
2,7	25	E14	4000	250	200°	78x45	<b>ELD3003X3</b>	8031453017149	10/100	
2,7	25	E14	6500	250	200°	78x45	<b>ELD3003X1</b>	8031453010034	10/100	
4,9	40	E14	2700	470	240°	78x45	<b>ELD3006X2</b>	8031453010126	10/100	
4,9	40	E14	3000	470	240°	78x45	<b>ELD3006X2BB</b>	8031453020095	10/100	
4,9	40	E14	4000	470	240°	78x45	<b>ELD3006X3</b>	8031453017170	10/100	
4,9	40	E14	6500	470	240°	78x45	<b>ELD3006X1</b>	8031453010096	10/100	
7,2	60	E14	2700	806	220°	85x45	<b>ELD3010X2</b>	8031453019105	10/100	
7,2	60	E14	3000	806	220°	85x45	<b>ELD3010X2BB</b>	8031453020101	10/100	
7,2	60	E14	4000	806	220°	85x45	<b>ELD3010X3</b>	8031453019112	10/100	
7,2	60	E14	6500	806	220°	85x45	<b>ELD3010X1</b>	8031453019099	10/100	
6,5	75	E14	2700	1055	150°	82x45	<b>ELD3011X2</b>	8031453033170	10/100	
6,5	75	E14	3000	1055	150°	82x45	<b>ELD3011X2BB</b>	8031453033187	10/100	
6,5	75	E14	4000	1055	150°	82x45	<b>ELD3011X3</b>	8031453033194	10/100	
6,5	75	E14	6500	1055	150°	82x45	<b>ELD3011X1</b>	8031453033163	10/100	

**OLIVA OPALE 220-240V**

BTL CATEGORIA SCONTO 21

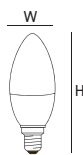
**IP 20**

 15.000h  
 2 ANNI GARANZIA

50.000



W	W=	BASE	K	lm		H x W mm	CODICE	EAN		
2,7	25	E14	2700	250	280°	102x35	<b>ELD2003X2</b>	8031453009946	10/100	
2,7	25	E14	4000	250	280°	102x35	<b>ELD2003X3</b>	8031453017231	10/100	
2,7	25	E14	6500	250	280°	102x35	<b>ELD2003X1</b>	8031453009915	10/100	
4,9	40	E14	2700	470	280°	102x35	<b>ELD2006X2</b>	8031453010003	10/100	
4,9	40	E14	3000	470	280°	102x35	<b>ELD2006X2BB</b>	8031453020132	10/100	
4,9	40	E14	4000	470	280°	102x35	<b>ELD2006X3</b>	8031453017262	10/100	
4,9	40	E14	6500	470	280°	102x35	<b>ELD2006X1</b>	8031453009977	10/100	
6,5	60	E14	2700	806	240°	102x35	<b>ELD2010X2</b>	8031453019075	10/100	
6,5	60	E14	3000	806	240°	102x35	<b>ELD2010X2BB</b>	8031453026417	10/100	
6,5	60	E14	4000	806	240°	102x35	<b>ELD2010X3</b>	8031453019082	10/100	
6,5	60	E14	6500	806	240°	102x35	<b>ELD2010X1</b>	8031453019068	10/100	
6,5	75	E14	2700	1055	240°	102x35	<b>ELD2011X2</b>	8031453033132	10/100	
6,5	75	E14	3000	1055	240°	102x35	<b>ELD2011X2BB</b>	8031453033149	10/100	
6,5	75	E14	4000	1055	240°	102x35	<b>ELD2011X3</b>	8031453033156	10/100	
6,5	75	E14	6500	1055	240°	102x35	<b>ELD2011X1</b>	8031453033125	10/100	

## GLOBO 95 OPALE 220-240V

NEW

BTL CATEGORIA SCONTO 21

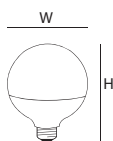

IP 20

20.000h  
2 ANNI GARANZIA

50.000



W	W=	BASE	K	lm		H x W mm	CODICE	EAN		
9,5	75	E27	2700	1055	180°	137x95	SLD4210X2B	8031453035211	6	
9,5	75	E27	4000	1055	180°	137x95	SLD4210X3B	8031453035228	6	
9,5	75	E27	6500	1055	180°	137x95	SLD4210X1B	8031453035204	6	
13,5	100	E27	2700	1521	180°	137x95	SLD4215X2B	8031453035242	6	
13,5	100	E27	4000	1521	180°	137x95	SLD4215X3B	8031453035259	6	
13,5	100	E27	6500	1521	180°	137x95	SLD4215X1B	8031453035235	6	

## GLOBO 120 OPALE 220-240V

BTL CATEGORIA SCONTO 21

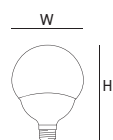

IP 20

20.000h  
2 ANNI GARANZIA

20.000



W	W=	BASE	K	lm		H x W mm	CODICE	EAN		
13,5	100	E27	2700	1521	200°	172x120	SLD4115X2B	8031453013776	6	
13,5	100	E27	4000	1521	200°	172x120	SLD4115X3B	8031453018894	6	
13,5	100	E27	6500	1521	200°	172x120	SLD4115X1B	8031453013752	6	
16,0	120	E27	2700	1900	200°	172x120	SLD4121X2B	8031453013813	6	
16,0	120	E27	3000	1900	200°	172x120	SLD4121X2BB	8031453022594	6	
16,0	120	E27	4000	1900	200°	172x120	SLD4121X3B	8031453018863	6	
16,0	120	E27	6500	1900	200°	172x120	SLD4121X1B	8031453013790	6	
20,0	150	E27	2700	2452	180°	172x120	SLD4122X2B	8031453015190	6	
20,0	150	E27	3000	2452	180°	172x120	SLD4122X2BB	8031453022600	6	
20,0	150	E27	4000	2452	180°	172x120	SLD4122X3B	8031453018870	6	
20,0	150	E27	6500	2452	180°	172x120	SLD4122X1B	8031453015176	6	



**GOCCIA OPALE DIMMERABILE 220-240V**

BTL CATEGORIA SCONTO 21

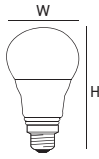

IP 20

25.000h  
3 ANNI GARANZIA

40.000



W	W=	BASE	K	lm		H x W mm	CODICE	EAN		
8,4	60	E27	2700	806	240°	110x60	SLD1009X2D	8031453014254	10/50	
13,6	100	E27	2700	1521	220°	120x60	SLD1014X2D	8031453012113	10/50	
13,6	100	E27	4000	1521	220°	120x60	SLD1014X3D	8031453023904	10/50	
18,0	150	E27	2700	2452	200°	143x67	SLD1021X2D	8031453023911	10/50	
21,0	150	E27	4000	2452	200°	143x67	SLD1021X3D	8031453023928	10/50	



**SFERA OPALE DIMMERABILE 220-240V**

BTL CATEGORIA SCONTO 21

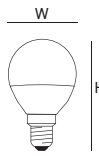

IP 20

25.000h  
3 ANNI GARANZIA

40.000



W	W=	BASE	K	lm		H x W mm	CODICE	EAN		
4,5	40	E14	2700	470	240°	78x45	SLD3006X2D	8031453012175	10/100	



**OLIVA OPALE DIMMERABILE 220-240V**

BTL CATEGORIA SCONTO 21

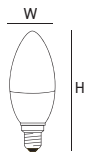

IP 20

25.000h  
3 ANNI GARANZIA

40.000



W	W=	BASE	K	lm		H x W mm	CODICE	EAN		
4,9	40	E14	2700	470	280°	102x35	SLD2006X2D	8031453012144	10/50	



### PICCOLA PERA PER FRIGORIFERI 220-240V

BTL CATEGORIA SCONTO 21

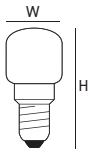

IP 20

20.000h  
2 ANNI GARANZIA

20.000



W	W=	BASE	K	lm		H x W mm	CODICE	EAN		
1,3	16	E14	6500	150	120°	55x25	SLD7102X1FRB	8031453018986	20/200	



### PICCOLA PERA 220-240V

BTL CATEGORIA SCONTO 21

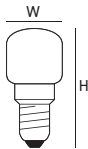

IP 20

20.000h  
2 ANNI GARANZIA

20.000



W	W=	BASE	K	lm		H x W mm	CODICE	EAN		
1,3	16	E14	3000	150	120°	55x25	SLD7102X2B	8031453018993	20/200	

## PICCOLA PERA COLORATA 220-240V

BTL CATEGORIA SCONTO 21

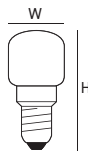

IP 20

20.000h  
2 ANNI GARANZIA

20.000



W	W=	BASE	COLOR	lm		H x W mm	CODICE	EAN		
1,5	-	E14	BLUE	25	120°	55x25	<b>SLD7202XB</b>	8031453019006	20/200	-
1,5	-	E14	GREEN	200	120°	55x25	<b>SLD7202XG</b>	8031453019013	20/200	-
1,5	-	E14	RED	20	120°	55x25	<b>SLD7202XR</b>	8031453019020	20/200	-



## PICCOLA PERA 24V DC

BTL CATEGORIA SCONTO 21

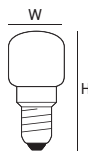

IP 20

15.000h  
2 ANNI GARANZIA

30.000



per cancelli / for gates

W	W=	BASE	K	lm		H x W mm	CODICE	EAN		
1,6	-	E14	2700	200	120°	56x25	<b>SLD7102X2DC</b>	8031453025069	20/200	



## TUBOLARE T37 220-240V

BTL CATEGORIA SCONTO 21



IP 20

20.000h  
2 ANNI GARANZIA

20.000



W	W=	BASE	K	lm		H x W mm	CODICE	EAN		
7,0	60	E14	2700	806	270°	126x38	<b>SLD7308X2</b>	8031453017941	10/50	
7,0	60	E14	4000	806	270°	126x38	<b>SLD7308X3</b>	8031453021559	10/50	
7,0	60	E14	6500	806	270°	126x38	<b>SLD7308X1</b>	8031453017910	10/50	
8,0	75	E14	2700	1055	270°	126x38	<b>SLD7309X2</b>	8031453024178	10/50	
8,0	75	E14	4000	1055	270°	126x38	<b>SLD7309X3</b>	8031453024185	10/50	
8,0	75	E14	6500	1055	270°	126x38	<b>SLD7309X1</b>	8031453024161	10/50	
7,0	60	E27	2700	806	270°	126x38	<b>SLD7408X2</b>	8031453018009	10/50	
7,0	60	E27	4000	806	270°	126x38	<b>SLD7408X3</b>	8031453021566	10/50	
7,0	60	E27	6500	806	270°	126x38	<b>SLD7408X1</b>	8031453017972	10/50	



## TUBOLARE T45 220-240V

BTL CATEGORIA SCONTO 21



IP 20

20.000h  
2 ANNI GARANZIA

20.000



W	W=	BASE	K	lm		H x W mm	CODICE	EAN		
9,5	75	E27	2700	1055	270°	152x45	<b>SLD7410X2</b>	8031453018061	10/50	
9,5	75	E27	4000	1055	270°	152x45	<b>SLD7410X3</b>	8031453021573	10/50	
9,5	75	E27	6500	1055	270°	152x45	<b>SLD7410X1</b>	8031453018030	10/50	
12,0	100	E27	2700	1521	270°	152x45	<b>SLD7414X2</b>	8031453021597	10/50	
12,0	100	E27	4000	1521	270°	152x45	<b>SLD7414X3</b>	8031453021603	10/50	
12,0	100	E27	6500	1521	270°	152x45	<b>SLD7414X1</b>	8031453021580	10/50	



**REFLECTOR R39 220-240V**

BTL CATEGORIA SCONTO 21



IP 20

20.000h  
2 ANNI GARANZIA

15.000



W	W=	BASE	K	lm		H x W mm	CODICE	EAN		
2,5	25	E14	2700	250	120°	67x39	<b>SLD500352B</b>	8031453018702	10/50	
3,0	25	E14	4000	250	120°	67x39	<b>SLD500353B</b>	8031453018726	10/50	
3,0	25	E14	6500	250	120°	67x39	<b>SLD500351B</b>	8031453018689	10/50	



**REFLECTOR R50 220-240V**

BTL CATEGORIA SCONTO 21



IP 20

20.000h  
2 ANNI GARANZIA

20.000



W	W=	BASE	K	lm		H x W mm	CODICE	EAN		
4,9	40	E14	2700	470	120°	83x50	<b>SLD500552B</b>	8031453018788	10/50	
4,9	40	E14	3000	470	120°	83x50	<b>SLD500552BB</b>	8031453020033	10/50	
4,9	40	E14	4000	470	120°	83x50	<b>SLD500553B</b>	8031453018795	10/50	
4,9	40	E14	6500	470	120°	83x50	<b>SLD500551B</b>	8031453018740	10/50	



## REFLECTOR R63 220-240V

BTL CATEGORIA SCONTO 21



IP 20

20.000h  
2 ANNI GARANZIA

20.000



W	W=	BASE	K	lm		H x W mm	CODICE	EAN		
8,0	60	E27	2700	806	120°	97x63	<b>SLD500952B</b>	8031453018818	10/50	
8,0	60	E27	3000	806	120°	97x63	<b>SLD500952BB</b>	8031453020040	10/50	
8,0	60	E27	4000	806	120°	97x63	<b>SLD500953B</b>	8031453018825	10/50	
8,0	60	E27	6500	806	120°	97x63	<b>SLD500951B</b>	8031453018801	10/50	



## REFLECTOR R80 220-240V

BTL CATEGORIA SCONTO 21



IP 20

20.000h  
2 ANNI GARANZIA

20.000



W	W=	BASE	K	lm		H x W mm	CODICE	EAN		
9,5	75	E27	2700	1055	120°	114x81	<b>SLD501252B</b>	8031453018849	10/50	
9,5	75	E27	4000	1055	120°	114x81	<b>SLD501253B</b>	8031453018856	10/50	
9,5	75	E27	6500	1055	120°	114x81	<b>SLD501251B</b>	8031453018832	10/50	



**LED GU10 H - 36° 220-240V**

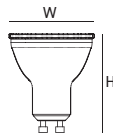

BTL CATEGORIA SCONTO 21



W	W=	BASE	K	lm	lm	cd		H x W mm	CODICE	EAN		
2,2	50	GU10	3000	360	350	650	36°	54x50	<b>SLH630232</b>	8031453029135	10/100	
2,0	50	GU10	4000	380	360	600	36°	54x50	<b>SLH630233</b>	8031453029142	10/100	
2,0	50	GU10	6500	380	360	600	36°	54x50	<b>SLH630231</b>	8031453029128	10/100	



**LED GU10 H - 100° 220-240V**

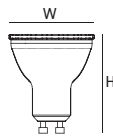

BTL CATEGORIA SCONTO 21



W	W=	BASE	K	lm	lm	cd		H x W mm	CODICE	EAN		
4,7	90	GU10	3000	890	850	420	100°	56x50	<b>SLH630552</b>	8031453031831	10/100	
4,7	90	GU10	4000	890	850	420	100°	56x50	<b>SLH630553</b>	8031453031848	10/100	
4,7	90	GU10	6500	890	850	420	100°	56x50	<b>SLH630551</b>	8031453031824	10/100	



**LED GU10 HP - 36° 220-240V**

BTL CATEGORIA SCONTO 21

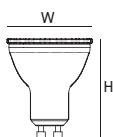

IP 20

15.000h  
2 ANNI GARANZIA

15.000



W	W=	BASE	K	lm	lm	cd		H x W mm	CODICE	EAN		
7,0	135	GU10	2700	1100	1000	1800	36°	56x50	<b>SLD631032B</b>	8031453032784	10/100	C
7,0	135	GU10	3000	1100	1000	1800	36°	56x50	<b>SLD631032BB</b>	8031453032791	10/100	C
7,0	135	GU10	4000	1100	1000	1800	36°	56x50	<b>SLD631033B</b>	8031453032807	10/100	C
7,0	135	GU10	6500	1100	1000	1800	36°	56x50	<b>SLD631031B</b>	8031453032777	10/100	C



**LED GU10 HP - 100° 220-240V**

BTL CATEGORIA SCONTO 21

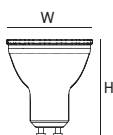

IP 20

15.000h  
2 ANNI GARANZIA

15.000



W	W=	BASE	K	lm	lm	cd		H x W mm	CODICE	EAN		
7,0	110	GU10	2700	1100	1000	750	100°	56x50	<b>SLD631052B</b>	8031453032821	10/100	C
7,0	110	GU10	3000	1100	1000	750	100°	56x50	<b>SLD631052BB</b>	8031453032838	10/100	C
7,0	110	GU10	4000	1100	1000	750	100°	56x50	<b>SLD631053B</b>	8031453032845	10/100	C
7,0	110	GU10	6500	1100	1000	750	100°	56x50	<b>SLD631051B</b>	8031453032814	10/100	C

**LED GU10 - 36° 220-240V**

BTL CATEGORIA SCONTO 21

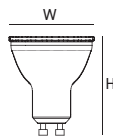
**IP 20**

 20.000h  
 2 ANNI GARANZIA

15.000



W	W=	BASE	K	lm	lm	cd		H x W mm	CODICE	EAN			
4,2	50	GU10		2700	370	345	640	36°	54x50	<b>SLD630532B</b>	8031453018498	10/100	
4,2	50	GU10		4000	370	345	640	36°	54x50	<b>SLD630533B</b>	8031453018504	10/100	
4,2	50	GU10		6500	370	345	640	36°	54x50	<b>SLD630531B</b>	8031453018481	10/100	
4,9	75	GU10		2700	595	535	950	36°	54x50	<b>SLD630732B</b>	8031453018559	10/100	
4,9	75	GU10		3000	595	540	1000	36°	54x50	<b>SLD630732BB</b>	8031453019662	10/100	
4,9	75	GU10		4000	595	535	950	36°	54x50	<b>SLD630733B</b>	8031453018566	10/100	
4,9	75	GU10		6500	595	535	950	36°	54x50	<b>SLD630731B</b>	8031453018542	10/100	

**LED GU10 - 60° 220-240V**

BTL CATEGORIA SCONTO 21

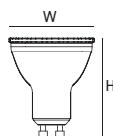
**IP 20**

 20.000h  
 2 ANNI GARANZIA

15.000



W	W=	BASE	K	lm	lm	cd		H x W mm	CODICE	EAN			
4,2	44	GU10		2700	360	345	440	60°	54x50	<b>SLD630542B</b>	8031453018528	10/100	
4,2	44	GU10		4000	360	345	450	60°	54x50	<b>SLD630543B</b>	8031453018535	10/100	
4,2	44	GU10		6500	360	345	480	60°	54x50	<b>SLD630541B</b>	8031453018511	10/100	
4,9	70	GU10		2700	570	500	600	60°	54x50	<b>SLD630742B</b>	8031453018580	10/100	
4,9	70	GU10		3000	570	500	600	60°	54x50	<b>SLD630742BB</b>	8031453019679	10/100	
4,9	70	GU10		4000	570	500	600	60°	54x50	<b>SLD630743B</b>	8031453018597	10/100	
4,9	70	GU10		6500	570	500	600	60°	54x50	<b>SLD630741B</b>	8031453018573	10/100	

**LED GU10 - 110° 220-240V**

BTL CATEGORIA SCONTO 21

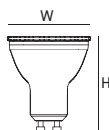

IP 20

20.000h  
2 ANNI GARANZIA

15.000



W	W=	BASE	K	lm	lm	cd		H x W mm	CODICE	EAN		
4,9	57	GU10	2700	560	535	250	110°	54x50	SLD630752B	8031453018610	10/100	A+ G E
4,9	57	GU10	3000	560	535	250	110°	54x50	SLD630752BB	8031453019686	10/100	A+ G E
4,9	57	GU10	4000	560	535	250	110°	54x50	SLD630753B	8031453018627	10/100	A+ G E
4,9	57	GU10	6500	560	535	250	110°	54x50	SLD630751B	8031453018603	10/100	A+ G E
7,1	61	GU10	2700	830	670	300	100°	57x50	SLD630952B	8031453023065	10/100	A+ G E
7,1	61	GU10	3000	830	670	300	100°	57x50	SLD630952BB	8031453023072	10/100	A+ G E
7,1	61	GU10	4000	830	670	300	100°	57x50	SLD630953B	8031453023089	10/100	A+ G E
7,1	61	GU10	6500	830	670	300	100°	57x50	SLD630951B	8031453023058	10/100	A+ G E

**LED GU10 HP - 100° - DIMMERABILE 220-240V**

NEW

BTL CATEGORIA SCONTO 21

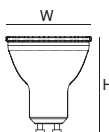

IP 20

15.000h  
2 ANNI GARANZIA

50.000



W	W=	BASE	K	lm	lm	cd		H x W mm	CODICE	EAN		
6,5	95	GU10	3000	950	900	460	100°	56x50	SLD631052BBD	8031453034795	10/100	A+ G C
6,5	102	GU10	4000	1000	950	480	100°	56x50	SLD631053BD	8031453034801	10/100	A+ G C

**LED GU10 DIMMERABILE 220-240V**

BTL CATEGORIA SCONTO 21

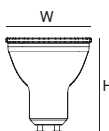

IP 20

25.000h  
3 ANNI GARANZIA

30.000



W	W=	BASE	K	lm	lm	cd		H x W mm	CODICE	EAN		
5,7	70	GU10	3000	600	500	500	60°	54x50	SLD630842D	8031453013554	10/100	A+ G F
5,7	81	GU10	4000	590	580	540	60°	54x50	SLD630843D	8031453018665	10/100	A+ G E

**LED GU10 ALL-GLASS H 220-240V**

BTL CATEGORIA SCONTO 21

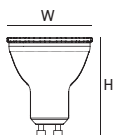

IP 20

 50.000h  
 5 ANNI GARANZIA

50.000



W	W=	BASE	K	lm	lm	cd		H x W mm	CODICE	EAN		
4,7	100	GU10	3000	780	750	1350	36°	53x50	<b>SLH620532</b>	8031453034702	10/100	A+G
4,7	100	GU10	4000	890	850	1400	36°	53x50	<b>SLH620533</b>	8031453034719	10/100	A+G
4,7	100	GU10	3000	890	850	450	100°	53x50	<b>SLH620552</b>	8031453034726	10/100	A+G
4,7	100	GU10	4000	890	850	450	100°	53x50	<b>SLH620553</b>	8031453034733	10/100	A+G

**LED GU10 ALTA TEMPERATURA 220-240V**

BTL CATEGORIA SCONTO 21

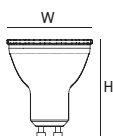

IP 20

 10.000h  
 2 ANNI GARANZIA

20.000



W	W=	BASE	K	lm	lm	cd		H x W mm	CODICE	EAN		
4,0	70	GU10	3000	560	500	950	36°	53x50	<b>SLD620432HT</b>	8031453028749	10/100	A+G
4,0	70	GU10	4000	560	500	950	36°	53x50	<b>SLD620433HT</b>	8031453028756	10/100	A+G
4,0	70	GU10	6500	560	500	950	36°	53x50	<b>SLD620431HT</b>	8031453028732	10/100	A+G
4,0	70	GU10	3000	560	500	540	60°	53x50	<b>SLD620442HT</b>	8031453028770	10/100	A+G
4,0	70	GU10	4000	560	500	540	60°	53x50	<b>SLD620443HT</b>	8031453028787	10/100	A+G
4,0	70	GU10	6500	560	500	540	60°	53x50	<b>SLD620441HT</b>	8031453028763	10/100	A+G
4,0	42	GU10	3000	500	-	-	120°	55x50	<b>SLD620452HT</b>	8031453028800	10/100	A+G
4,0	42	GU10	4000	500	-	-	120°	55x50	<b>SLD620453HT</b>	8031453028817	10/100	A+G
4,0	42	GU10	6500	500	-	-	120°	55x50	<b>SLD620451HT</b>	8031453028794	10/100	A+G

**LED GU10 ALL-GLASS FASCIO STRETTO 220-240V**

BTL CATEGORIA SCONTO 21

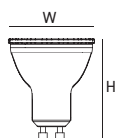

IP 20

15.000h  
2 ANNI GARANZIA

15.000



W	W=	BASE	K	lm	lm	cd		H x W mm	CODICE	EAN		
5,0	50	GU10	3000	500	450	2300	15°	53x50	SLD620512	8031453028893	10/100	F
5,0	50	GU10	4000	500	450	2350	15°	53x50	SLD620513	8031453028909	10/100	F



**LED GU10 ALL-GLASS 220-240V**

BTL CATEGORIA SCONTO 21

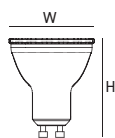

IP 20

15.000h  
2 ANNI GARANZIA

40.000



W	W=	BASE	K	lm	lm	cd		H x W mm	CODICE	EAN		
4,0	50	GU10	3000	390	345	750	36°	52x50	SLD620532	8031453020507	10/100	F
5,5	75	GU10	3000	575	535	900	36°	54x50	SLD620732	8031453020514	10/100	E
5,5	75	GU10	3000	600	535	385	60°	52x50	SLD620742	8031453019747	10/100	E
5,5	75	GU10	3000	575	500	240	110°	52x50	SLD620752	8031453019754	10/100	F



**LED GU10 ALL-GLASS DIMMERABILE 220-240V**

BTL CATEGORIA SCONTO 21

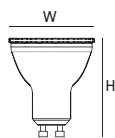

IP 20

25.000h  
3 ANNI GARANZIA

40.000



W	W=	BASE	K	lm	lm	cd		H x W mm	CODICE	EAN		
3,6	50	GU10	2700	420	345	750	36°	54x50	SLD620532BD	8031453031800	10/100	E
3,6	50	GU10	3000	440	345	750	36°	52x50	SLD620532D	8031453019761	10/100	E
5,5	75	GU10	2700	635	535	900	36°	54x50	SLD620732BD	8031453031817	10/100	E
5,5	75	GU10	3000	635	535	900	36°	54x50	SLD620732D	8031453023935	10/100	E



**LED MR11 AC/DC 12V**

BTL CATEGORIA SCONTO 21

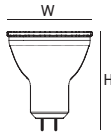

\_ Si consiglia l'uso di alimentatori LED in DC o trasformatori ferromagnetici. Nel caso di trasformatori elettronici in AC verificare il corretto funzionamento ed i valori di corrente e tensione

\_ We recommend the use of LED DC power supplies or ferromagnetic transformers. In the case of AC electronic transformers, check correct operation and the current

IP 20

25.000h  
3 ANNI GARANZIA

30.000



W	W=	BASE	K	lm	lm	cd		H x W mm	CODICE	EAN		
2,3	21	GU4	2700	230	200	500	36°	40x34	<b>SLD660332</b>	8031453017538	10/100	



**LED MR16 AC/DC 12V**

BTL CATEGORIA SCONTO 21

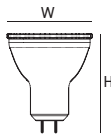

\_ Si consiglia l'uso di alimentatori LED in DC o trasformatori ferromagnetici. Nel caso di trasformatori elettronici in AC verificare il corretto funzionamento ed i valori di corrente e tensione

\_ We recommend the use of LED DC power supplies or ferromagnetic transformers. In the case of AC electronic transformers, check correct operation and the current

IP 20

20.000h  
2 ANNI GARANZIA

15.000



W	W=	BASE	K	lm	lm	cd		H x W mm	CODICE	EAN		
6,9	43	GU5.3	2700	560	500	540	60°	48x50	<b>SLD650742B</b>	8031453018641	10/100	
6,9	43	GU5.3	4000	560	500	540	60°	48x50	<b>SLD650743B</b>	8031453018658	10/100	
6,9	43	GU5.3	6500	560	520	540	60°	48x50	<b>SLD650741B</b>	8031453018634	10/100	



### LED MR16 ALL-GLASS AC/DC 12V

BTL CATEGORIA SCONTO 21

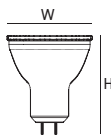

\_ Si consiglia l'uso di alimentatori LED in DC o trasformatori ferromagnetici. Nel caso di trasformatori elettronici in AC verificare il corretto funzionamento ed i valori di corrente e tensione

\_ We recommend the use of LED DC power supplies or ferromagnetic transformers. In the case of AC electronic transformers, check correct operation and the current

IP 20

 15.000h  
2 ANNI GARANZIA

40.000



W	W=	BASE	K	lm	lm	cd		H x W mm	CODICE	EAN		
6,2	38	GU5.3	3000	500	400	450	60°	45x50	<b>SLD670642</b>	8031453019778	10/100	



### LED MR16 ALL-GLASS DIMMERABILE AC/DC 12V

BTL CATEGORIA SCONTO 21

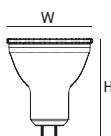

\_ Si consiglia l'uso di alimentatori LED in DC o trasformatori ferromagnetici. Nel caso di trasformatori elettronici in AC verificare il corretto funzionamento ed i valori di corrente e tensione

\_ We recommend the use of LED DC power supplies or ferromagnetic transformers. In the case of AC electronic transformers, check correct operation and the current

IP 20

 25.000h  
3 ANNI GARANZIA

40.000



W	W=	BASE	K	lm	lm	cd		H x W mm	CODICE	EAN		
4,9	35	GU5.3	3000	470	360	510	60°	45x50	<b>SLD670642D</b>	8031453021405	10/100	

## LED PAR30 WATERPROOF IP65 DIMMERABILE 220-240V

BTL CATEGORIA SCONTO 21

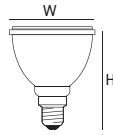

IP 65

25.000h  
3 ANNI GARANZIA

40.000



W	W=	BASE	K	lm	lm		H x W mm	CODICE	EAN		
9,5	75	E27	3000	870	800	40°	90x95	<b>SLD551022D</b>	8031453026035	40	
9,5	75	E27	4000	870	800	40°	90x95	<b>SLD551023D</b>	8031453026042	40	



## LED PAR38 WATERPROOF IP65 DIMMERABILE 220-240V

BTL CATEGORIA SCONTO 21

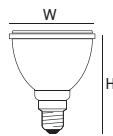

IP 65

25.000h  
3 ANNI GARANZIA

40.000



W	W=	BASE	K	lm	lm		H x W mm	CODICE	EAN		
16,0	120	E27	3000	1540	1400	40°	133x121	<b>SLD561622D</b>	8031453026059	20	
16,0	120	E27	4000	1540	1400	40°	133x121	<b>SLD561623D</b>	8031453026066	20	

**LED BISPINA G4 AC/DC 12V**

BTL CATEGORIA SCONTO 21



\_ Si consiglia l'uso di alimentatori LED in DC o trasformatori ferromagnetici. Nel caso di trasformatori elettronici in AC verificare il corretto funzionamento ed i valori di corrente e tensione

\_ We recommend the use of LED DC power supplies or ferromagnetic transformers. In the case of AC electronic transformers, check correct operation and the current

IP 20    15.000h 2 ANNI GARANZIA    40.000   

W	W=	BASE	K	lm		H x W mm	CODICE	EAN		
1,0	-	G4	2700	110	320°	37,5x9,7	<b>SLD8601X2</b>	8031453017385	10	
1,0	-	G4	4000	110	320°	37,5x9,7	<b>SLD8601X3</b>	8031453017408	10	
2,5	-	G4	2700	250	320°	46x13	<b>SLD8603X2</b>	8031453017422	10	
2,5	-	G4	4000	250	320°	46x13	<b>SLD8603X3</b>	8031453017521	10	

**LED BISPINA G4 SATINATA AC/DC 12V**

BTL CATEGORIA SCONTO 21



\_ Si consiglia l'uso di alimentatori LED in DC o trasformatori ferromagnetici. Nel caso di trasformatori elettronici in AC verificare il corretto funzionamento ed i valori di corrente e tensione

\_ We recommend the use of LED DC power supplies or ferromagnetic transformers. In the case of AC electronic transformers, check correct operation and the current

IP 20    25.000h 3 ANNI GARANZIA    15.000   

W	W=	BASE	K	lm		H x W mm	CODICE	EAN		
1,5	-	G4	2700	180	320°	36x10	<b>SLD8202X2</b>	8031453012564	10	
1,5	-	G4	4000	180	320°	36x10	<b>SLD8202X3</b>	8031453014933	10	

**LED BISPINA G4 CHIARA AC/DC 12V**

BTL CATEGORIA SCONTO 21



\_ Si consiglia l'uso di alimentatori LED in DC o trasformatori ferromagnetici. Nel caso di trasformatori elettronici in AC verificare il corretto funzionamento ed i valori di corrente e tensione

\_ We recommend the use of LED DC power supplies or ferromagnetic transformers. In the case of AC electronic transformers, check correct operation and the current

IP 20    15.000h 2 ANNI GARANZIA    15.000   

W	W=	BASE	K	lm		H x W mm	CODICE	EAN		
1,8	-	G4	3000	180	305°	38x13	<b>SLD8902X2</b>	8031453029388	20/200	
1,8	-	G4	4000	180	305°	38x13	<b>SLD8902X3</b>	8031453029395	20/200	
2,4	-	G4	3000	280	305°	44x13	<b>SLD8903X2</b>	8031453029401	20/200	
2,4	-	G4	4000	280	305°	44x13	<b>SLD8903X3</b>	8031453029418	20/200	



**LED G9 ALL-GLASS 220-240V**

BTL CATEGORIA SCONTO 21



IP 20

20.000h  
2 ANNI GARANZIA

20.000



W	W=	BASE	K	lm		H x W mm	CODICE	EAN		
2,2	-	G9	3000	250	330°	53x15	<b>SLD8702X2S</b>	8031453025342	20/200	
2,2	-	G9	4000	250	330°	53x15	<b>SLD8702X3S</b>	8031453025359	20/200	
4,2	-	G9	3000	470	330°	56x18	<b>SLD8704X2S</b>	8031453025366	20/200	
4,2	-	G9	4000	470	330°	56x18	<b>SLD8704X3S</b>	8031453025373	20/200	



**LED G9 220-240V**

BTL CATEGORIA SCONTO 21

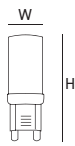

IP 20

25.000h  
3 ANNI GARANZIA

40.000



W	W=	BASE	K	lm		H x W mm	CODICE	EAN		
4,5	-	G9	3000	500	320°	54x19	<b>SLD8505X2</b>	8031453022891	10	
4,5	-	G9	4000	500	320°	54x19	<b>SLD8505X3</b>	8031453022907	10	
7,0	-	G9	3000	700	320°	70x21	<b>SLD8507X2</b>	8031453025427	10	
7,0	-	G9	4000	700	320°	70x21	<b>SLD8507X3</b>	8031453025434	10	



**LED G9 DIMMERABILE 220-240V**

BTL CATEGORIA SCONTO 21

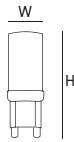

W	W=	BASE	K	lm		H x W mm	CODICE	EAN		
4,0	-	G9	3000	400	320°	54x19	<b>SLD8505X2D</b>	8031453022914	10	



**LED G9 COB 220-240V**

BTL CATEGORIA SCONTO 21

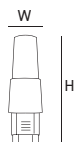

W	W=	BASE	K	lm		H x W mm	CODICE	EAN		
3,8	-	G9	3000	470	320°	60x20	<b>SLD8804X2</b>	8031453024888	20/400	
3,8	-	G9	4000	470	320°	60x20	<b>SLD8804X3</b>	8031453024895	20/400	



### LED LINEARE R7S 220-240V

BTL CATEGORIA SCONTO 21

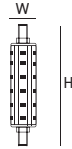

W	W=	BASE	K	lm		H x W mm	CODICE	EAN		
10,7	-	R7s	3000	1521	130°	118x22	<b>SLD9511X2</b>	8031453025489	10/50	
10,7	-	R7s	4000	1521	130°	118x22	<b>SLD9511X3</b>	8031453025496	10/50	



### LED LINEARE R7S DIMMERABILE 220-240V

BTL CATEGORIA SCONTO 21



W	W=	BASE	K	lm		H x W mm	CODICE	EAN		
8,2	-	R7s	3000	1055	130°	118x22	<b>SLD9508X2D</b>	8031453025472	10/50	

**LED LINEARE R7S 78MM 220-240V**

BTL CATEGORIA SCONTO 21

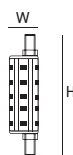

IP 20

15.000h  
2 ANNI GARANZIA

10.000



W	W=	BASE	K	lm		H x W mm	CODICE	EAN		
8,2	-	R7s	3000	1055	360°	78x29	SLD9610X2	8031453019150	10/50	

**LED LINEARE R7S 2000LM DIMMERABILE 220-240V**

BTL CATEGORIA SCONTO 21

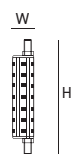

IP 20

25.000h  
3 ANNI GARANZIA

15.000



W	W=	BASE	K	lm		H x W mm	CODICE	EAN		
15,5	-	R7s	3000	2000	360°	118x29	SLD9716X2D	8031453019167	10/50	
15,5	-	R7s	4000	2000	360°	118x29	SLD9716X3D	8031453020521	10/50	

**LED LINEARE R7S 3000LM 220-240V** NEW

BTL CATEGORIA SCONTO 21

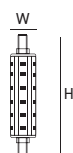

IP 20

20.000h  
2 ANNI GARANZIA

20.000



W	W=	BASE	K	lm		H x W mm	CODICE	EAN		
18,0	-	R7s	3000	3000	270°	118x28	SLD9730X2	8031453034771	10/100	
18,0	-	R7s	4000	3000	270°	118x28	SLD9730X3	8031453034788	10/100	

**PL ALC LED 220-240V**

BTL CATEGORIA SCONTO 21



W	W=	BASE	K	lm		H x W mm	CODICE	EAN		
11,5	-	G24d	3000	1000	120°	152x35	<b>SLD751052</b>	8031453022112	10/50	
11,5	-	G24d	4000	1000	120°	152x35	<b>SLD751053</b>	8031453022129	10/50	

**PL AL LED 220-240V**

BTL CATEGORIA SCONTO 21



W	W=	BASE	K	lm		H x W mm	CODICE	EAN		
5,7	-	G23	3000	460	180°	167x32	<b>SLD760552</b>	8031453022136	10/50	
5,7	-	G23	4000	510	180°	167x32	<b>SLD760553</b>	8031453022143	10/50	
7,2	-	G23	3000	670	180°	228x32	<b>SLD760752</b>	8031453022150	10/50	
7,2	-	G23	4000	720	180°	228x32	<b>SLD760753</b>	8031453022167	10/50	

**PL ALL LED 220-240V**

BTL CATEGORIA SCONTO 21



W	W=	BASE	K	lm		H x W mm	CODICE	EAN		
8,0	-	2G11	4000	1000	140°	224x43,6	<b>SLD770853</b>	8031453031688	10/50	
12,0	-	2G11	4000	1500	140°	319x43,6	<b>SLD771253</b>	8031453031695	10/50	
16,5	-	2G11	4000	2100	140°	398x43,6	<b>SLD771753</b>	8031453031701	10/50	
24,0	-	2G11	4000	3400	140°	521x43,6	<b>SLD772453</b>	8031453031718	10/50	



## LED AR111 CRI>97 DIMMERABILE AC/DC 12V

BTL CATEGORIA SCONTO 21

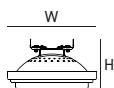

\_ G53: Si consiglia l'uso di alimentatori LED in DC o trasformatori ferromagnetici. Nel caso di trasformatori elettronici in AC verificare il corretto funzionamento ed i valori di corrente e tensione.

\_ G53: The use of LED DC power supplies or ferromagnetic transformers is recommended. In the case of AC electronic transformers, check the correct operation on the current.



W	W=	BASE	K	lm		H x W mm	CODICE	EAN		
13,0	-	G53	3000	1100	40°	61x111	SLD5713329	8031453024666	20	
13,0	-	G53	4000	1100	40°	61x111	SLD5713339	8031453024673	20	



## LED GX53 220-240V

BTL CATEGORIA SCONTO 21

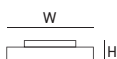

W	W=	BASE	K	lm		H x W mm	CODICE	EAN		
6,5	-	GX53	3000	650	110°	25x75	ELD770752	8031453020576	10/50	
6,5	-	GX53	4000	650	110°	25x75	ELD770753	8031453020583	10/50	
8,0	-	GX53	3000	900	120°	25x75	ELD770852	8031453026431	10/50	
8,0	-	GX53	4000	900	120°	25x75	ELD770853	8031453026448	10/50	



### LED LINEARLINE 300MM 220-240V

BTL CATEGORIA SCONTO 21

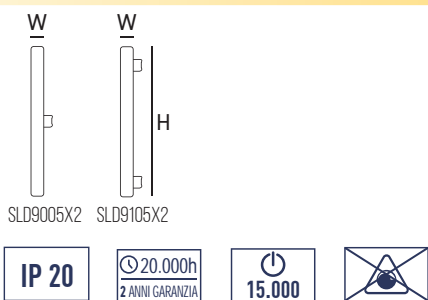

W	W=	BASE	K	lm		H x W mm	CODICE	EAN		
5,0	-	S14d	2700	450	150°	300x49	<b>SLD9005X2</b>	8031453011659	10/50	
5,0	-	S14s	2700	300	200°	300x48	<b>SLD9105X2</b>	8031453011710	10/50	



### LED LINEARLINE 500MM 220-240V

BTL CATEGORIA SCONTO 21

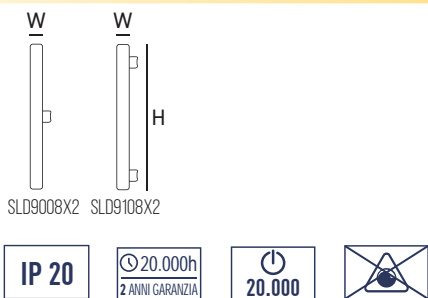

W	W=	BASE	K	lm		H x W mm	CODICE	EAN		
7,5	-	S14d	2700	700	150°	500x48	<b>SLD9008X2</b>	8031453011680	10/50	
7,5	-	S14s	2700	700	150°	500x48	<b>SLD9108X2</b>	8031453011741	10/50	



### LED LINEARLINE 1000MM 220-240V

BTL CATEGORIA SCONTO 21



W	W=	BASE	K	lm		H x W mm	CODICE	EAN		
11,0	-	S14s	2700	1055	200°	1000x30	<b>SLD9114X2</b>	8031453015602	30	



## LAMPADA ELLITTICA SMD HID 220-240V

BTL CATEGORIA SCONTO 21



IP 20

15.000h  
2 ANNI GARANZIA

20.000



W	W=	BASE	K	lm		H x W mm	CODICE	EAN		
52,0	-	E27	4000	7600	330°	264x108	SLD9975X3	8031453028725	20	
52,0	-	E40	4000	7600	330°	274x108	SLD9975X3E40	8031453028718	20	



## LAMPADA ELLISSOIDALE ALTA POTENZA HID 220-240V

BTL CATEGORIA SCONTO 21



\_ Sistema di protezione da sbalzi di tensione fino a 4kV \_ Power surge protection system up to 4kV

IP 65

25.000h  
3 ANNI GARANZIA

40.000

SURGE  
PROTECTION

W	W=	BASE	K	lm		H x W mm	CODICE	EAN		
36,0	-	E27	2000	4200	320°	229x90	SLD9850X2W	8031453024949	12	-
36,0	-	E27	3000	5000	320°	229x90	SLD9850X2	8031453024932	12	
34,0	-	E27	4000	5000	330°	230x90	SLD9850X3	8031453028541	6	
36,0	-	E27	5000	5000	320°	229x90	SLD9850X1	8031453024956	12	
30,0	-	E27	2000	3200	320°	195x75	SLD9840X2W	8031453024918	12	-
28,0	-	E27	3000	4000	330°	196x75	SLD9840X2	8031453024901	6	
28,0	-	E27	4000	4000	330°	195x75	SLD9840X3	8031453028534	6	
34,0	-	E40	3000	5000	330°	215x90	SLD9850X2E40	8031453028558	6	
34,0	-	E40	4000	5000	330°	215x90	SLD9850X3E40	8031453028565	6	

## LAMPADA TUBOLARE ALTA POTENZA HID 220-240V

BTL CATEGORIA SCONTO 21

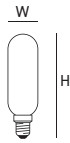

IP 65

25.000h  
3 ANNI GARANZIA

20.000



W	W=	BASE	K	lm		H x W mm	CODICE	EAN		
28,0	-	E27	3000	4500	330°	223x46	<b>SLD9845X2</b>	8031453028572	6	
28,0	-	E27	4000	4500	330°	223x46	<b>SLD9845X3</b>	8031453028589	6	
38,0	-	E40	3000	7200	330°	207x46	<b>SLD9875X2E40</b>	8031453028596	6	
38,0	-	E40	4000	7500	330°	207x46	<b>SLD9875X3E40</b>	8031453028602	6	



## GOCCIA OPALE CON SENSORE CREPUSCOLARE 220-240V

BTL CATEGORIA SCONTO 21

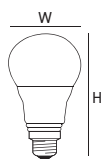

\_ Doppio sensore crepuscolare sul corpo della lampada

\_ Double dusk sensor on the body of the lamp

IP 20

25.000h  
3 ANNI GARANZIA

30.000



AUTOMATIC ON-OFF

W	W=	BASE	K	lm		H x W mm	CODICE	EAN		
10,7	75	E27	2700	1060	200°	120x60	LEDSENS10X2B	8031453019174	10/50	
10,7	75	E27	4000	1060	200°	120x60	LEDSENS10X3B	8031453019181	10/50	

## GOCCIA OPALE CON SENSORE DI MOVIMENTO E CREPUSCOLARE 220-240V

BTL CATEGORIA SCONTO 21

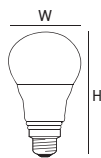

\_ Rilevato il movimento la lampada si accende per 45 secondi al 100% dell'emissione luminosa e per i successivi 15 secondi passa al 50% del flusso.

\_ When movement is detected the lamp turns ON at 100% luminous flux for 45 seconds, for the following 15 seconds the flux reduces at 50% of emission.

Se non viene rilevato ulteriore movimento la lampada si spegne.

If no other movement is detected, the lamp turns OFF

\_ Sensore crepuscolare

\_Dusk sensor

IP 20

15.000h  
2 ANNI GARANZIA

30.000



AUTOMATIC ON-OFF

W	W=	BASE	K	lm		H x W mm	CODICE	EAN		
9,5	75	E27	2700	1060	200°	120x60	SLD1011X2M	8031453026424	10/50	

## GOCCIA OPALE 12/24V AC/DC

BTL CATEGORIA SCONTO 21

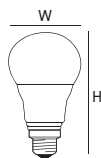

\_ Si consiglia l'uso di alimentatori LED in DC o trasformatori ferromagnetici. Nel caso di trasformatori elettronici in AC verificare il corretto funzionamento ed i valori di corrente e tensione.

\_ We recommend the use of LED DC power supplies or ferromagnetic transformers. In case of AC electronic transformers, check correct operation and electric parameters.

IP 20

20.000h  
2 ANNI GARANZIA

20.000



W	W=	BASE	K	lm		H x W mm	CODICE	EAN		
8,0	60	E27	2700	806	180°	112x60	SLD1009X2DC	8031453019198	10/50	
8,0	60	E27	4000	806	180°	112x60	SLD1009X3DC	8031453032227	10/50	
8,5	75	E27	2700	1055	180°	120x60	SLD1009X2DC2	8031453026400	10/50	



**GOCCIA LED FROST PER CELLA FRIGORIFERA -40 °C 220-240V**

BTL CATEGORIA SCONTO 21

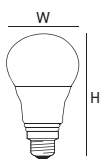

IP 20

25.000h  
3 ANNI GARANZIA

1.000.000



W	W=	BASE	K	lm		H x W mm	CODICE	EAN		
5,5	40	E27	2800	470	240°	102x60	<b>4711394</b>	6435200192097	10/60	
8,5	60	E27	4000	840	200°	102x60	<b>4711395</b>	6435200192110	10/60	
8,0	60	E27	2800	810	200°	102x60	<b>4711503</b>	6435200203779	10/100	
10,5	75	E27	4000	1055	240°	120x60	<b>4711504</b>	6435200203793	10/100	



**GOCCIA LED ANTIZANZARE 220-240V**

BTL CATEGORIA SCONTO 21

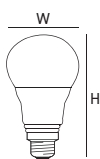

\_ Lampada con funzione color switch 4000K oppure luce gialla antizanzare.

\_ Lamp with 4000K color switch function or yellow anti-mosquito light

IP 20

25.000h  
3 ANNI GARANZIA

40.000

4000 K



W	W=	BASE	K	lm		H x W mm	CODICE	EAN		
8,0	60	E27	4000	806	220°	110x60	<b>ELD1008X3AM</b>	8031453020002	10/50	



**GOCCIA LED PER SAUNA +60 °C 220-240V**

BTL CATEGORIA SCONTO 21

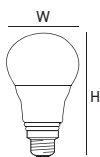

IP 20

10.000h  
2 ANNI GARANZIA

500.000



W	W=	BASE	K	lm		H x W mm	CODICE	EAN		
4,5	40	E27	2800	470	240°	109x61	<b>4711528</b>	6435200206367	10/100	



**GOCCIA LED SURGE PROTECTION 220-240V**

BTL CATEGORIA SCONTO 21

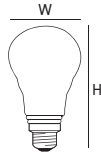

\_ Sistema di protezione da sbalzi di tensione fino a 2,5kV

\_ Power surge protection system up to 2.5kV



W	W=	BASE	K	lm		H x W mm	CODICE	EAN		
9,5	75	E27	2700	1055	180°	109x60	<b>SLD1011X2SP</b>	8031453021221	10/50	
9,5	75	E27	4000	1055	180°	109x60	<b>SLD1011X3SP</b>	8031453021238	10/50	



**LED PLANT PAR20 PER CRESCITA PIANTE 220-240V**

BTL CATEGORIA SCONTO 21

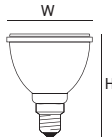

W	W=	BASE	K	lm	lm	cd		H x W mm	CODICE	EAN		
6,2	-	E14	3500	400	400	1350	40°	90x63	<b>4713401</b>	6435200235299	10/100	



**LED PLANT PAR30 PER CRESCITA PIANTE 220-240V**

BTL CATEGORIA SCONTO 21

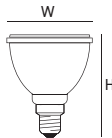

W	W=	BASE	K	lm	lm	cd		H x W mm	CODICE	EAN		
9,5	-	E27	3500	800	800	2300	40°	115x95	<b>4711773</b>	6435200231246	10/40	



LAMPADE CCT 220-240V

BTL CATEGORIA SCONTO 21



IP 20

20.000h  
2 ANNI GARANZIA

20.000



CCT

W	W=	BASE	K	lm	cd		H x W mm	CODICE	EAN		
9,0	60	E27	<input type="checkbox"/> 3000 <input type="checkbox"/> 4000 <input type="checkbox"/> 6500	806	-	200°	108x60	<b>SMM1008XK</b>	8031453030599	10/100	
7,0	50	GU10	<input type="checkbox"/> 3000 <input type="checkbox"/> 4000 <input type="checkbox"/> 6500	700	250	110°	55x50	<b>SMM63055K</b>	8031453030582	10/100	
8,0	60	E27	<input type="checkbox"/> 3000 <input type="checkbox"/> 4000 <input type="checkbox"/> 6500	806	-	220°	116x37	<b>SMM7408XK</b>	8031453030575	10/100	

**TUBO LED VETRO T8 A-CLASS 220-240V**

BTL CATEGORIA SCONTO 21

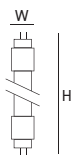

\_ Starter incluso  
 \_ Non compatibile con reattori elettronici  
 \_ Per la sostituzione di tubi fluorescenti seguire queste indicazioni (W fluorescenza / lunghezza LED): 36W / 120cm, 58W / 150cm

\_ Starter included  
 \_ Not compatible with electronic ballast  
 \_ For replacing fluorescent tubes, follow these indications (fluorescent W / LED length): 36W / 120cm, 58W / 150cm

**IP 20**

**PF > 0,9**

W	W=	BASE	K	lm		H x W mm	CODICE	EAN		
12,0	-	G13	4000	2550	250°	1200x26	<b>LT12123H</b>	8031453028060	10	
17,0	-	G13	4000	3600	250°	1500x26	<b>LT15173H</b>	8031453028077	10	

**TUBO LED VETRO T8 HIGH EFFICIENCY 220-240V**

BTL CATEGORIA SCONTO 21

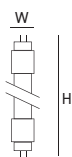

\_ Starter incluso  
 \_ Non compatibile con reattori elettronici  
 \_ Per la sostituzione di tubi fluorescenti seguire queste indicazioni (W fluorescenza / lunghezza LED): 18W / 60cm, 30W / 90cm, 36W / 120cm, 58W / 150cm

\_ Starter not included  
 \_ Not compatible with electronic ballast  
 \_ For replacing fluorescent tubes, follow these indications (fluorescent W / LED length): 18W / 60cm, 30W / 90cm, 36W / 120cm, 58W / 150cm

**IP 20**

**PF > 0,9**

W	W=	BASE	K	lm		H x W mm	CODICE	EAN		
9,0	-	G13	4000	1350	250°	600x26	<b>LT06093H</b>	8031453025397	25	
9,0	-	G13	6500	1350	250°	600x26	<b>LT06091H</b>	8031453025380	25	
17,5	-	G13	4000	2600	250°	1200x26	<b>LT12183H</b>	8031453022549	25	
17,5	-	G13	6500	2600	250°	1200x26	<b>LT12181H</b>	8031453025403	25	
22,0	-	G13	4000	3300	250°	1500x26	<b>LT15243H</b>	8031453022556	25	
22,0	-	G13	6500	3300	250°	1500x26	<b>LT15241H</b>	8031453025410	25	
26,5	-	G13	4000	4000	250°	1500x26	<b>LT15273H</b>	8031453034382	25	
26,5	-	G13	6500	4000	250°	1500x26	<b>LT15271H</b>	8031453034375	25	



## TUBO LED VETRO T8 220-240V

BTL CATEGORIA SCONTO 21

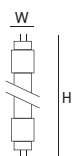

\_Tubi venduti in imballo industriale, starter acquistabile separatamente

\*Starter incluso solo per articoli  
LT06093E.1 - LT12183E.1 - LT15243E.1 (pack 10 pezzi)

\_Non compatibile con reattori elettronici  
\_Per la sostituzione di tubi fluorescenti seguire queste indicazioni (W fluorescenza / lunghezza LED): 18W / 60cm, 30W / 90cm, 36W / 120cm, 58W / 150cm

\_Tubes sold in industrial packaging, starter available separately

\*Starter included only for items  
LT06093E.1 - LT12183E.1 - LT15243E.1 (pack of 10 pieces)

\_Not compatible with electronic ballast  
\_For replacing fluorescent tubes, follow these indications (fluorescent W / LED length): 18W / 60cm, 30W / 90cm, 36W / 120cm, 58W / 150cm

IP 20

 30.000h  
3 ANNI GARANZIA

200.000



 PF  
> 0,9

W	W=	BASE	K	lm		H x W mm	CODICE	EAN		
7,5	-	G13	3000	900	250°	600x26	<b>LT06092E</b>	8031453023157	25	
7,5	-	G13	4000	900	250°	600x26	<b>LT06093E</b>	8031453020606	25	
7,5	-	G13	4000	900	250°	600x26	<b>LT06093E.1*</b>	8031453026127	10	
7,5	-	G13	6500	900	250°	600x26	<b>LT06091E</b>	8031453020590	25	
10,0	-	G13	4000	1200	250°	900x26	<b>LT09133E</b>	8031453022099	25	
10,0	-	G13	6500	1200	250°	900x26	<b>LT09131E</b>	8031453022082	25	
15,0	-	G13	3000	1800	250°	1200x26	<b>LT12182E</b>	8031453023164	25	
15,0	-	G13	4000	1800	250°	1200x26	<b>LT12183E</b>	8031453020620	25	
15,0	-	G13	4000	1800	250°	1200x26	<b>LT12183E.1*</b>	8031453026134	10	
15,0	-	G13	6500	1800	250°	1200x26	<b>LT12181E</b>	8031453020613	25	
19,0	-	G13	3000	2300	250°	1500x26	<b>LT15242E</b>	8031453023171	25	
19,0	-	G13	4000	2300	250°	1500x26	<b>LT15243E</b>	8031453020644	25	
19,0	-	G13	4000	2300	250°	1500x26	<b>LT15243E.1*</b>	8031453026141	10	
19,0	-	G13	6500	2300	250°	1500x26	<b>LT15241E</b>	8031453020637	25	



### TUBO LED VETRO T8 SE 220-240V

BTL CATEGORIA SCONTO 21

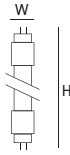

\_Tubi venduti in imballo industriale, starter acquistabile separatamente  
\_Non compatibile con reattori elettronici  
\_Per la sostituzione di tubi fluorescenti seguire queste indicazioni (W fluorescenza / lunghezza LED): 18W / 60cm, 36W / 120cm, 58W / 150cm

\_Tubes sold in industrial packaging, starter available separately  
\_Not compatible with electronic ballast  
\_For replacing fluorescent tubes, follow these indications (fluorescent W / LED length): 18W / 60cm, 36W / 120cm, 58W / 150cm



W	W=	BASE	K	lm		H x W mm	CODICE	EAN		
9,0	-	G13	4000	900	250°	600x26	LT06093SE	8031453034320	25	
9,0	-	G13	6500	900	250°	600x26	LT06091SE	8031453034313	25	
17,5	-	G13	4000	1800	250°	1200x26	LT12183SE	8031453034344	25	
17,5	-	G13	6500	1800	250°	1200x26	LT12181SE	8031453034337	25	
22,0	-	G13	4000	2300	250°	1500x26	LT15223SE	8031453034368	25	
22,0	-	G13	6500	2300	250°	1500x26	LT15221SE	8031453034351	25	



### TUBO LED VETRO T8 FOOD 220-240V

BTL CATEGORIA SCONTO 21

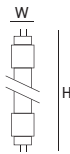

\_ Tubo per carni - starter incluso  
\_ Non compatibile con reattori elettronici

\_ Meat light tube - starter included  
\_ Not compatible with electronic ballast

\* I valori di flusso luminoso (lumen) tra sorgenti a luce bianca (es. 4000K) e sorgenti a luce speciale (es. spettro "Food") non sono direttamente comparabili. Per ulteriori informazioni consultare la scheda tecnica.

\* Luminous flux values (lumens) for white-light sources (e.g. 4000K) and special-light sources (e.g. "Food" spectrum) are not directly comparable. For further information, please refer to the technical data sheet.



W	W=	BASE	K	lm		H x W mm	CODICE	EAN		
5,2	-	G13	3300	500*	190°	600x27	LT0605FL	8031453028336	10	-
7,9	-	G13	3300	750*	200°	900x27	LT0908FL	8031453022389	10	-
11,6	-	G13	3300	1100*	200°	1200x27	LT1212FL	8031453022396	10	-
17,9	-	G13	3300	1700*	200°	1500x27	LT1518FL	8031453022402	10	-

**TUBO LED VETRO T5 - MAINS 220-240V**

BTL CATEGORIA SCONTO 21

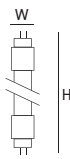

\_ Non compatibile con reattori elettronici

\_ Not compatible with electronic ballast

IP 20   25.000h 3 ANNI GARANZIA   200.000  

W	W=	BASE	K	lm		H x W mm	CODICE	EAN		
8,0	-	G5	3000	1200	250°	549x18	L506082AC	8031453031947	10	
8,0	-	G5	4000	1200	250°	549x18	L506083AC	8031453031954	10	
12,0	-	G5	3000	1800	250°	849x18	L509122AC	8031453031961	10	
12,0	-	G5	4000	1800	250°	849x18	L509123AC	8031453031978	10	
16,0	-	G5	3000	2400	250°	1149x18	L512162AC	8031453031985	10	
16,0	-	G5	4000	2400	250°	1149x18	L512163AC	8031453031992	10	
20,0	-	G5	3000	3000	250°	1449x18	L515202AC	8031453032005	10	
20,0	-	G5	4000	3000	250°	1449x18	L515203AC	8031453032012	10	

**CIRCOLINE T9 LED 220-240V**

BTL CATEGORIA SCONTO 21

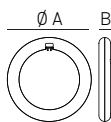

\_ Starter incluso  
\_ Non compatibile con reattori elettronici  
\_ Fissaggio magnetico

\_ Starter included  
\_ Not compatible with electronic ballast  
\_ Magnetic fixing

IP 20   20.000h 2 ANNI GARANZIA   25.000    

W	W=	BASE	K	lm		A x B mm	CODICE	EAN		
14	-	G10Q	3000 4000 6000	1600	180°	215x32	LC22K	8031453034672	20	
19	-	G10Q	3000 4000 6000	2200	180°	300x32	LC32K	8031453034689	20	
24	-	G10Q	3000 4000 6000	2700	180°	400x32	LC40K	8031453034696	10	

**STARTER PER TUBI T8 A LED**

\_ Non compatibile con circoline LED

\_ Not compatible with circular LED tube

BTL CATEGORIA SCONTO 21



CODICE	EAN	IMBALLO
LTSTU2	8031453020651	25

**SHOT**  
BOT LIGHTING

**SORGENTI TRADIZIONALI**  
TRADITIONAL LIGHT SOURCES







## LINEARE ENERGY SAVING R7S DIMMERABILE 230V

BTL CATEGORIA SCONTO 8

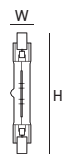

W	W=	BASE	K	lm		H x W mm	CODICE	EAN		
80	-	R7s	2900	1380	360°	79x9	<b>J8079ES</b>	6435200013873	20/100	
120	-	R7s	2900	2250	360°	79x9	<b>J12079ES</b>	6435200013323	20/100	
80	-	R7s	2900	1380	360°	119x9	<b>J80ES</b>	6435200015075	20/100	
120	-	R7s	2900	2250	360°	119x9	<b>J120ES</b>	6435200013835	20/100	



## SPOT RAGGI INFRAROSSI

BTL CATEGORIA SCONTO 2

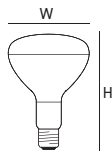

W	W=	BASE	K	lm		H x W mm	CODICE	EAN		
150	-	E27	-	-	-	175x125	<b>R1150</b>	8031453031770	5/30	-
250	-	E27	-	-	-	175x125	<b>R1250</b>	8031453031787	5/30	-



**PICCOLA PERA CHIARA 230V**

BTL CATEGORIA SCONTO 2

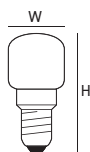

W	W=	BASE	K	lm		H x W mm	CODICE	EAN		
13	-	E14	2100	40	300°	56x25	PP05CM	6435200007285	50	-



**PICCOLA PERA CHIARA PER FORNI 300 °C 230V**

BTL CATEGORIA SCONTO 2

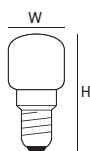

W	W=	BASE	K	lm		H x W mm	CODICE	EAN		
15	-	E14	2100	50	300°	50x22	PP15MFF240	6435200007292	50	-
25	-	E14	2200	120	300°	56x25	PP25MFF	6435200153425	50	-



## NACHROMA ELLISSOIALE DIFFONDENTE

BTL CATEGORIA SCONTO 7

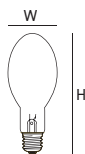

- \_ Lampada al sodio ad alta pressione ellissoidale con bulbo diffondente
- \_ Adatta per reattore ai vapori di sodio ad alta pressione (RENA).
- \_ Necessita di accenditore ad esclusione di NAE70SI

- \_ High pressure ellipsoidal sodium lamp with diffusing bulb
- \_ Suitable for high pressure sodium vapor reactor (RENA)
- \_ Requires igniter except NAE70SI

**MH**

W	W=	BASE	K	lm		H x W mm	CODE	EAN		
70	-	E27	2500	5600	-	156x75	<b>NAE70SI</b>	-	1/12	-
70	-	E27	2500	6100	-	156x70	<b>NAE70</b>	-	1/12	-
100	-	E40	2500	9500	-	186x75	<b>NAE100</b>	-	1/12	-
150	-	E40	2500	16700	-	227x90	<b>NAE150</b>	-	1/12	-



## NATRALOX SUPER TUBOLARE TRASPARENTE

BTL CATEGORIA SCONTO 7



- \_ Lampada al sodio ad alta pressione tubolare con bulbo trasparente
- \_ Adatta per reattore ai vapori di sodio ad alta pressione (RENA).
- \_ Necessita di accenditore

- \_ Tubular high pressure sodium lamp with transparent bulb
- \_ Suitable for high pressure sodium vapor reactor (RENA)
- \_ Requires an igniter

**HPS**

W	W=	BASE	K	lm		H x W mm	CODICE	EAN		
100	-	E40	2500	10000	-	211x46	<b>NATS100</b>	-	12	-
150	-	E40	2500	17500	-	211x46	<b>NATS150</b>	-	12	-
250	-	E40	2500	33000	-	257x46	<b>NATS250</b>	-	12	-
400	-	E40	2500	54500	-	271x46	<b>NATS400</b>	-	12	-



# SHOT

## BOT LIGHTING

### LAMPADE UVC UVC LIGHT BULBS

#### INFORMAZIONI GENERALI

La radiazione ultravioletta è un metodo di sterilizzazione che usa la luce ultravioletta UVC con lunghezze d'onda comprese nella banda tra 280 e 100 nanometri, che modifica il DNA o l'RNA dei microorganismi come batteri, virus, acari ed altri, impedendo loro di riprodursi o di essere dannosi.

Utilizzare un dispositivo UV germicida in certi ambienti crea un effetto mortale su microorganismi patogeni, virus e muffe.

#### GENERAL INFORMATION

Ultraviolet radiation is a sterilization method that uses UVC ultraviolet light with wavelengths between 280 and 100 nanometers, which modifies the DNA or RNA of microorganisms such as bacteria, viruses, mites and others, preventing them from reproduce or be harmful.

Using a germicidal UV device creates a deadly effect on pathogenic microorganisms, viruses and molds.

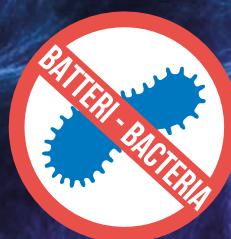

#### PL UVC



- \_ Lunghezza d'onda nello spettro di emissione UVC (280 - 200nm)
- \_ Vetro al quarzo
- \_ Eliminazione rapida di Batteri, Virus, Muffe e Acari
- \_ Nessuna produzione di ozono
- \_ Compatibile con i ballast per lampade a fluorescenza
- \_ Sistema HQ/HO alta emissione luminosa
- \_ Funzionamento con alimentatore elettronico

- \_ Wavelength in the UVC emission spectrum (280 - 200nm)
- \_ Quartz glass
- \_ Rapid elimination of Bacteria, Viruses, Molds and Mites
- \_ No ozone production
- \_ Compatible with ballasts for fluorescent lamps
- \_ High light emission HQ / HO system
- \_ Operation with electronic ballast

**UVC** **IP 20** **8.000h**

W	LUNGHEZZA D'ONDA nm	BASE	TENSIONE V	H x W mm	CODICE	EAN	
9	253,7	G23	54-66	165x12	AL9TUV	-	50
36	253,7	2G11	98-118	391x43	ALL36TUV	-	50



### TUBO T5 UVC

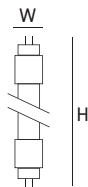

- \_ Lunghezza d'onda nello spettro di emissione UVC (280 - 200nm)
- \_ Vetro al quarzo
- \_ Eliminazione rapida di Batteri, Virus, Muffe e Acari
- \_ Nessuna produzione di ozono
- \_ Compatibile con i ballast per lampade a fluorescenza
- \_ Sistema HQ/HO alta emissione luminosa
- \_ Funzionamento con alimentatore elettronico

- \_ Wavelength in the UVC emission spectrum (280 - 200nm)
- \_ Quartz glass
- \_ Rapid elimination of Bacteria, Viruses, Molds and Mites
- \_ No ozone production
- \_ Compatible with ballasts for fluorescent lamps
- \_ High light emission HQ / HO system
- \_ Operation with electronic ballast

UVC

IP 20

W	LUNGHEZZA D'ONDA nm	BASE	TENSIONE V	H x W mm	CODICE	EAN	
6	253,7	G5	36-49	211x15	L6TG	-	10



### TUBO T8 UVC



- \_ Lunghezza d'onda nello spettro di emissione UVC (280 - 200nm)
- \_ Vetro al quarzo
- \_ Eliminazione rapida di Batteri, Virus, Muffe e Acari
- \_ Nessuna produzione di ozono
- \_ Compatibile con i ballast per lampade a fluorescenza
- \_ Sistema HQ/HO alta emissione luminosa
- \_ Funzionamento con alimentatore elettronico

- \_ Wavelength in the UVC emission spectrum (280 - 200nm)
- \_ Quartz glass
- \_ Rapid elimination of Bacteria, Viruses, Molds and Mites
- \_ No ozone production
- \_ Compatible with ballasts for fluorescent lamps
- \_ High light emission HQ / HO system
- \_ Operation with electronic ballast

UVC

IP 20

W	LUNGHEZZA D'ONDA nm	BASE	TENSIONE V	H x W mm	CODICE	EAN	
15	253,7	G13	46-64	437x25	L15TG	-	50
30	253,7	G13	102-125	895x25	L30TG	-	50
40	253,7	G13	102-125	1200x25	L36TG	-	50





**APPARECCHI DI ILLUMINAZIONE  
TECNICO / PLAFONIERE**

LIGHTING FIXTURES  
TECHNICAL / CEILING LAMPS

# IRIS ROUND

BTL CATEGORIA SCONTO 23

Plafoniera CCT / CCT ceiling light

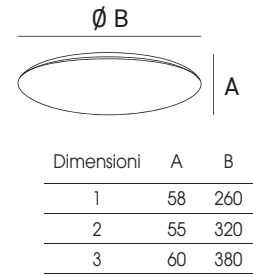

- \_ Plafoniera tonda con base in metallo e diffusore in tecnopolimero ad alta resistenza, ideale per interni
- \_ Versatile e di facile installazione a soffitto e parete
- \_ Flusso luminoso uniforme
- \_ CCT selezionabile

- \_ Round ceiling light with metal base and high-resistance technopolymer diffuser, ideal for indoor use
- \_ Versatile and easy to install on ceiling and wall
- \_ Uniform luminous flux
- \_ Selectable CCT



W	K	LUMEN APPARECCHIO lm	LUMEN SORGENTE lm	MISURE	VARIANTE	CODICE	EAN		
12	<input type="checkbox"/> 3000 <input type="checkbox"/> 4000 <input type="checkbox"/> 6500	1000	1400	120° 1	-	<b>IRIS12R</b>	8031453031725	1/20	
18	<input type="checkbox"/> 3000 <input type="checkbox"/> 4000 <input type="checkbox"/> 6500	1400	2200	120° 2	-	<b>IRIS18R</b>	8031453031749	1/10	
24	<input type="checkbox"/> 3000 <input type="checkbox"/> 4000 <input type="checkbox"/> 6500	1800	2700	120° 3	-	<b>IRIS24R</b>	8031453031756	1/10	

# IRIS SQUARED

BTL CATEGORIA SCONTO 23

Plafoniera CCT / CCT ceiling light

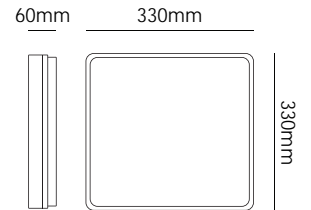

- \_ Plafoniera quadrata per interni con base in metallo e diffusore in tecnopolimero ad alta resistenza
- \_ Versatile e di facile installazione a soffitto e parete
- \_ Flusso luminoso uniforme
- \_ CCT selezionabile

- \_ Squared ceiling light with metal base and high-resistance technopolymer diffuser, ideal for indoor use
- \_ Versatile and easy to install on ceiling and wall
- \_ Uniform luminous flux
- \_ Selectable CCT



W	K	LUMEN APPARECCHIO lm	LUMEN SORGENTE lm		VARIANTE	CODICE	EAN		
24	<input type="checkbox"/> 3000 <input type="checkbox"/> 4000 <input type="checkbox"/> 6500	1800	2700	120°	-	IRIS24Q	8031453031763	1/10	

# VAASA

BTL CATEGORIA SCONTO 23

Plafoniera CCT / CCT ceiling light



Plafoniera LED dal design minimal, con potenza e colore della luce regolabili per adattarsi a ogni esigenza. Una soluzione pratica e funzionale, pensata per offrire la massima flessibilità in tutti i contesti

Minimalist LED ceiling light with adjustable power and light color to suit any need. A practical and functional solution designed to provide maximum flexibility in any setting

- \_ Plafoniera tonda in policarbonato adatta per ambienti interni, ideale per applicazioni a soffitto e parete
- \_ Di facile installazione a soffitto o a parete grazie alla staffa in dotazione
- \_ Montaggio ad incasso con staffa regolabile per foro 65-180mm
- \_ Disponibile variante con sensore di presenza PIR programmabile mediante dip-switch (ON/OFF, crepuscolare, durata)
- \_ Potenza selezionabile tramite l'apposito selettore
- \_ CCT selezionabile

- \_ Round polycarbonate ceiling light suitable for indoor environments, ideal for ceiling and wall applications
- \_ Easy to install on ceiling or wall thanks to the included bracket
- \_ Recessed installation with adjustable bracket for 65-180mm cut-out
- \_ Available version with PIR presence sensor programmable via dip-switch (ON/OFF, twilight, duration)
- \_ Power selectable via dedicated switch
- \_ Selectable CCT



W	K	LUMEN APPARECCHIO lm	LUMEN SORGENTE lm		VARIANTE	CODICE	EAN			
6	2700	600	750	120°	-	VAASA185KP	8031453033002	1/20		
12	3000	1200	1450							
18	3500	1700	2100							
	4000									
	5000									
6	2700	600	750	120°	SENSORE / SENSOR *	VAASA185KPS	8031453033019	1/20		
12	3000	1200	1450							
18	3500	1700	2100							
	4000									
	5000									

# VAASA BIG

Plafoniera CCT / CCT ceiling light

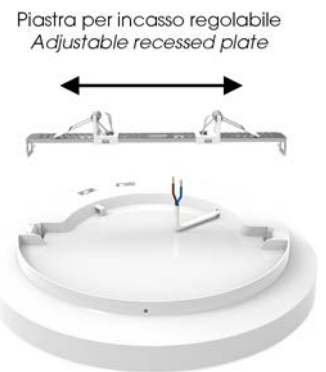
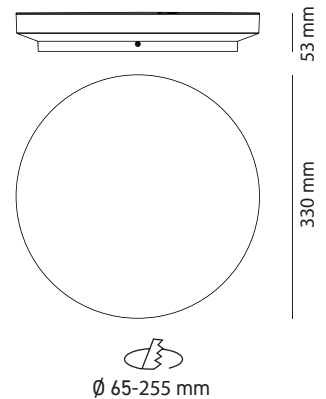

Plafoniera LED dal design minimal, con potenza e colore della luce regolabili per adattarsi a ogni esigenza. Una soluzione pratica e funzionale, pensata per offrire la massima flessibilità in tutti i contesti

Minimalist LED ceiling light with adjustable power and light color to suit any need. A practical and functional solution designed to provide maximum flexibility in any setting

- \_ Plafoniera tonda in policarbonato adatta per ambienti interni, ideale per applicazioni a soffitto e parete
- \_ Di facile installazione a soffitto o a parete grazie alla staffa in dotazione
- \_ Montaggio ad incasso con staffa regolabile per foro 65-255mm
- \_ Potenza selezionabile tramite l'apposito selettore
- \_ CCT selezionabile

- \_ Round polycarbonate ceiling light suitable for indoor environments, ideal for ceiling and wall applications
- \_ Easy to install on ceiling or wall thanks to the included bracket
- \_ Recessed installation with adjustable bracket for 65-255mm cut-out
- \_ Power selectable via dedicated switch
- \_ Selectable CCT

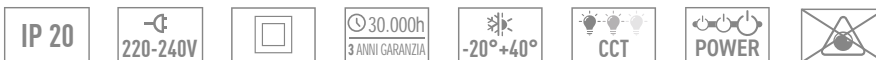

W	K	LUMEN APPARECCHIO lm	LUMEN SORGENTE lm		VARIANTE	CODICE	EAN		
8	2700	800	1050	120°	-	VAASA245KP	8031453033026	1/10	
16	3000	1600	2100						
24	3500	2200	2900						
	4000								
	5000								

# JUPITER

BTL CATEGORIA SCONTO 23

Plafoniera PIR / PIR ceiling light

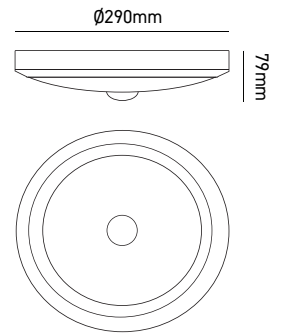

- \_ Plafoniera tonda in policarbonato adatta per ambienti interni, ideale per applicazioni a soffitto e parete
- \_ Sensore di presenza PIR regolabile: Tempo di accensione 5-90-180s Luminosità ambientale 5-50-2000lux
- \_ Raggio di rilevamento 4m per installazione a 3m di altezza
- \_ CCT selezionabile

- \_ Round polycarbonate ceiling light suitable for indoor environments, ideal for ceiling and wall applications
- \_ Adjustable PIR presence sensor: on-time 5-90-180 s, ambient brightness 5-50-2000 lux
- \_ Detection range: 4 m with installation at 3 m height
- \_ Selectable CCT



W	K	LUMEN APPARECCHIO lm	LUMEN SORGENTE lm		VARIANTE	CODICE	EAN		
18	<input type="checkbox"/> 3000 <input type="checkbox"/> 4000 <input type="checkbox"/> 6000	2000	2400	100°	-	JUPITER18PIR	8031453033729	1/10	

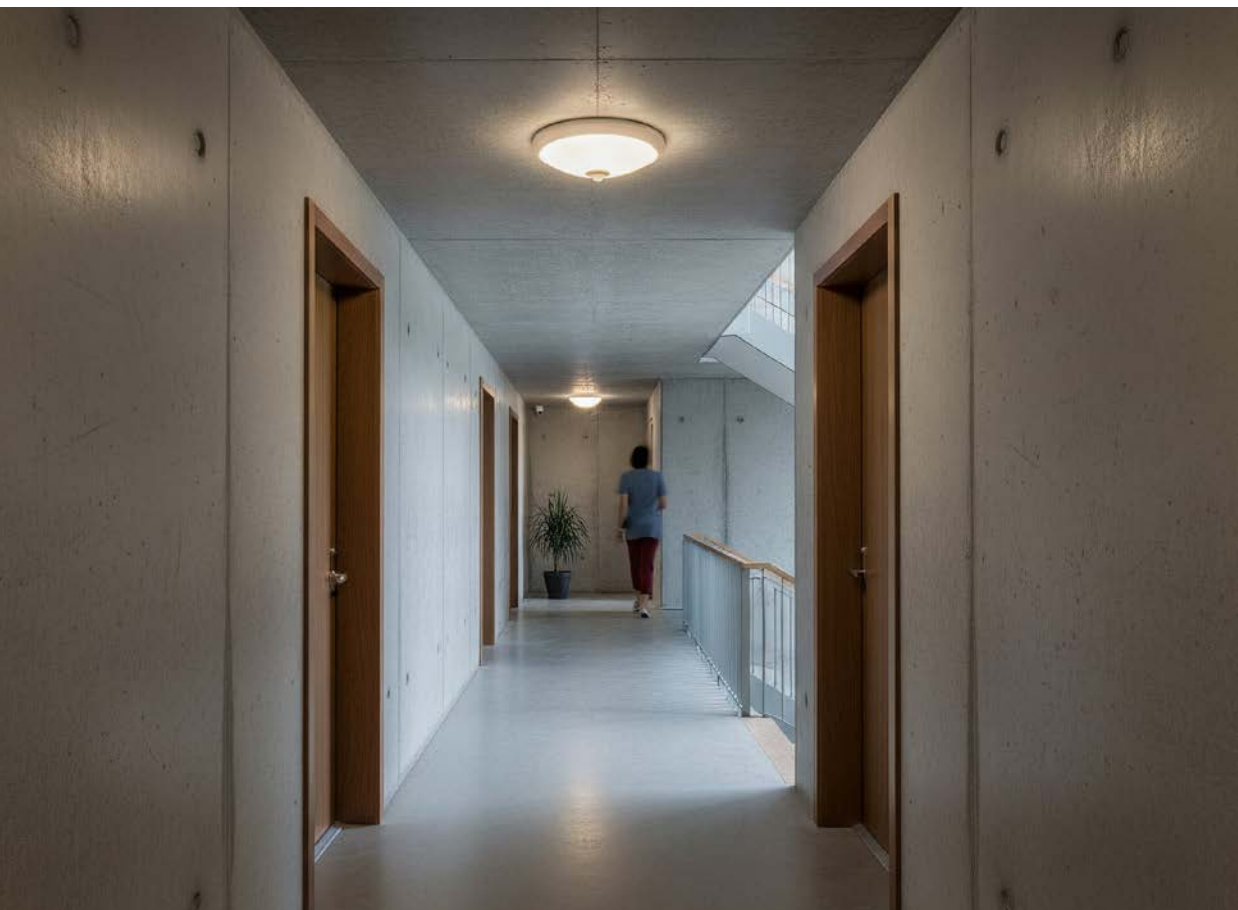
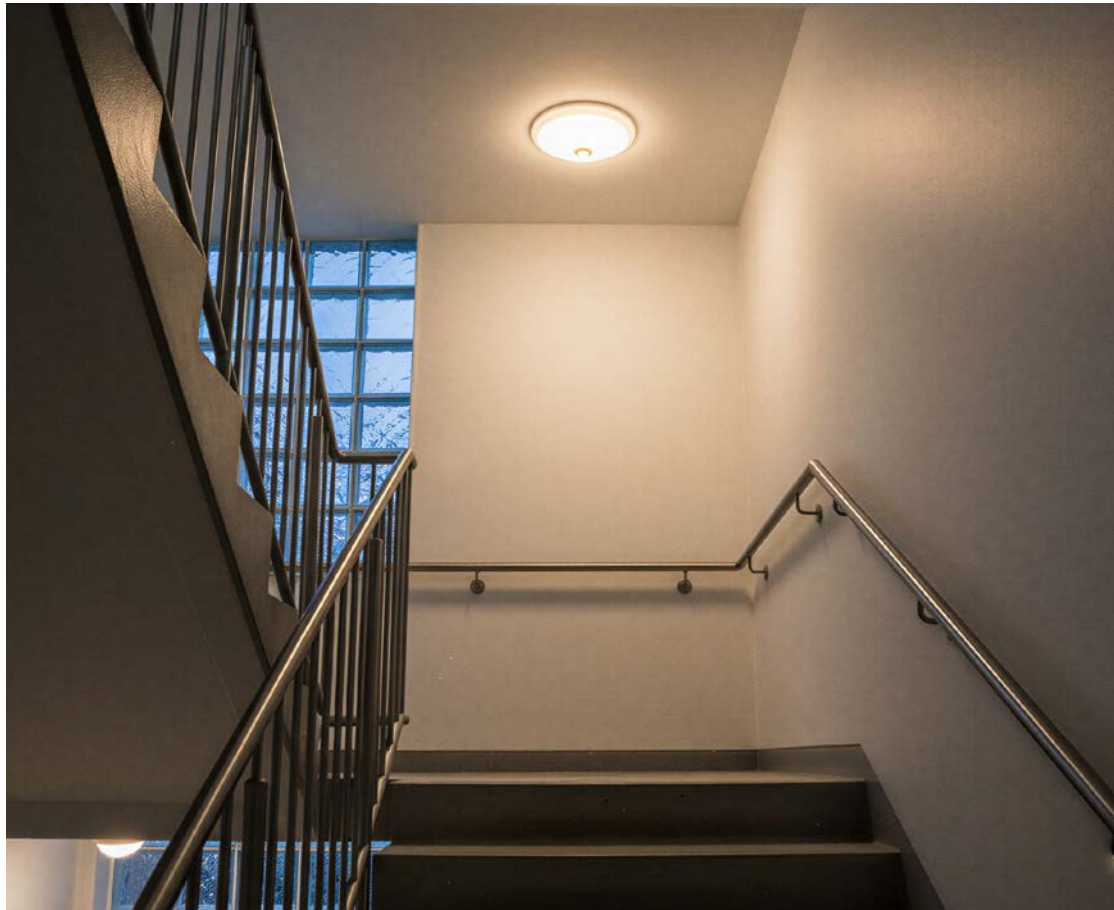

**JUPITER**

# LINDA

## Plafoniera CCT / CCT ceiling light

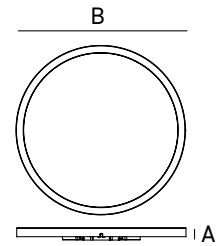

Dimensioni	A	B
1	22	283
2	22	383
3	24	483
4	24	583



DOWN LIGHT



ILLUMINAZIONE INDIRETTA  
INDIRECT LIGHTING



BIEMISSIONE  
DOUBLE EMISSION

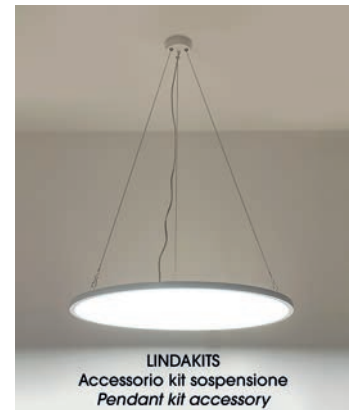

LINDAKITS  
Accessorio kit sospensione  
Pendant kit accessory

- \_ Plafoniera ultrasottile in policarbonato, ideale per interni
- \_ Installazione facilitata con fissaggio a slitta
- \_ Tre modalità di funzionamento: downlight, illuminazione indiretta e biemissione selezionabili tramite interruttore
- \_ Illuminazione indiretta 3000K
- \_ In opzione kit per installazione a sospensione
- \_ Potenza e CCT selezionabili

- \_ Ultra-slim polycarbonate ceiling light, ideal for indoor use
- \_ Easy installation with slide-in mounting
- \_ Three operating modes: downlight, indirect lighting, and bi-emission selectable via wall switch
- \_ 3000K indirect lighting
- \_ Optional suspension-mounting kit
- \_ Power and CCT selectable

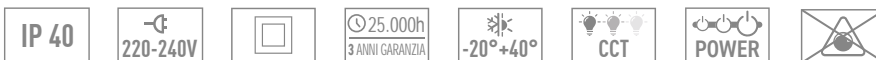

W	K	LUMEN APPARECCHIO lm	LUMEN SORGENTE lm	MISURE	VARIANTE	CODICE	EAN			
16	3000	1600	2300	120° 1	-	LINDA24KP	8031453034535	1/10		
20	4000	2000	3000							
24	6500	2400	3300							
24	3000	2400	3300	120° 2	-	LINDA32KP	8031453034573	1/10		
28	4000	2800	3800							
32	6500	3200	4400							
32	3000	3200	4400	120° 3	-	LINDA40KP	8031453034542	1/5		
36	4000	3600	5000							
40	6500	4000	5500							
40	3000	4000	5500	120° 4	-	LINDA48KP	8031453034580	1/5		
44	4000	4400	6200							
48	6500	4800	6800							
Kit sospensione per plafoniere LINDA / Suspension kit for LINDA ceiling lights						LINDAKITS	8031453034597	1		



LINDA

# COCO

BTL CATEGORIA SCONTO 23

Plafoniera / Ceiling light

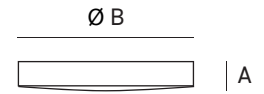

Dimensioni	A	B
1	65	310
2	65	360
3	65	410



- \_ Plafoniera tonda in policarbonato adatta per ambienti interni, ideale per applicazioni a soffitto e parete
- \_ Personalizzabile con anello di colore grigio incluso nella confezione
- \_ Flusso luminoso uniforme

- \_ Round polycarbonate ceiling light suitable for indoor environments, ideal for ceiling and wall applications
- \_ Customizable with grey ring included
- \_ Uniform luminous flux



W	K	LUMEN APPARECCHIO lm	LUMEN SORGENTE lm	MISURE	VARIANTE	CODICE	EAN		
14	3000	950	1700	120° 1	-	<b>COCO162</b>	8031453015237	1/5	A T G E
14	4000	950	1700	120° 1	-	<b>COCO163</b>	8031453015251	1/5	A T G E
17	3000	1200	2000	120° 2	-	<b>COCO212</b>	8031453015275	1/5	A T G E
17	4000	1200	2000	120° 2	-	<b>COCO213</b>	8031453025588	1/5	A T G E
24	3000	1700	2800	120° 3	-	<b>COCO242</b>	8031453025595	1/4	A T G E
24	4000	1700	2800	120° 3	-	<b>COCO243</b>	8031453025601	1/4	A T G E



**COCO**

# RIO

## Plafoniera / Ceiling light

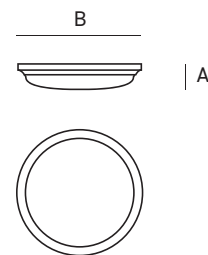

Dimensioni	A	B
1	80	305
2	88	400

- \_ Plafoniera in policarbonato versatile e di facile installazione (ad esempio per bagni, garage, corridoi, scale, etc.)
- \_ Disponibile in due dimensioni

- \_ Versatile, easy-to-install ceiling light with polycarbonate diffuser (e.g. for bathrooms, garages, corridors, stairs, etc.)
- \_ Available in two sizes



W	K	LUMEN APPARECCHIO lm	MISURE	VARIANTE	CODICE	EAN				
12		3000	1000	150°	1	-	<b>4116137</b>	6435200193445	1/6	
12		4000	1000	150°	1	-	<b>4116170</b>	6435200194237	1/6	
20		3000	1600	150°	2	-	<b>4116164</b>	6435200193452	1/6	

# RIO RADAR

BTL CATEGORIA SCONTO 23

Plafoniera con radar / Radar ceiling light

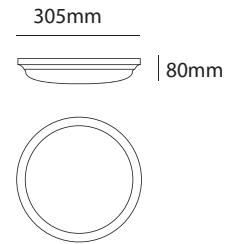

- \_ Plafoniera in policarbonato versatile e di facile installazione (ad esempio per bagni, garage, corridoi, scale, etc.)
- \_ Versione con sensore di movimento a microonde regolabile: - Luce ambiente: 2-50 lux - disabilitato. Distanza di rilevamento: 2-10m - Tempo di accensione: 5sec - 30min
- \_ Altezza di installazione: 2-3m

- \_ Versatile, easy-to-install ceiling light with polycarbonate diffuser (e.g. for bathrooms, garages, corridors, stairs, etc.)
- \_ Version with adjustable microwave movement sensor: - Ambient light level: 2-50 lux - disabled. Movement detection range: 2-10m - Light-on time: 5sec - 30min
- \_ Height of installation: 2-3m



W	K	LUMEN APPARECCHIO lm		VARIANTE	CODICE	EAN			
12	3000	1000	150°	-	4116165	6435200193469	1/6		

# ERIKA ROUND

BTL CATEGORIA SCONTO 23

Plafoniera CCT / CCT ceiling light

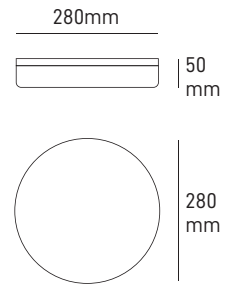
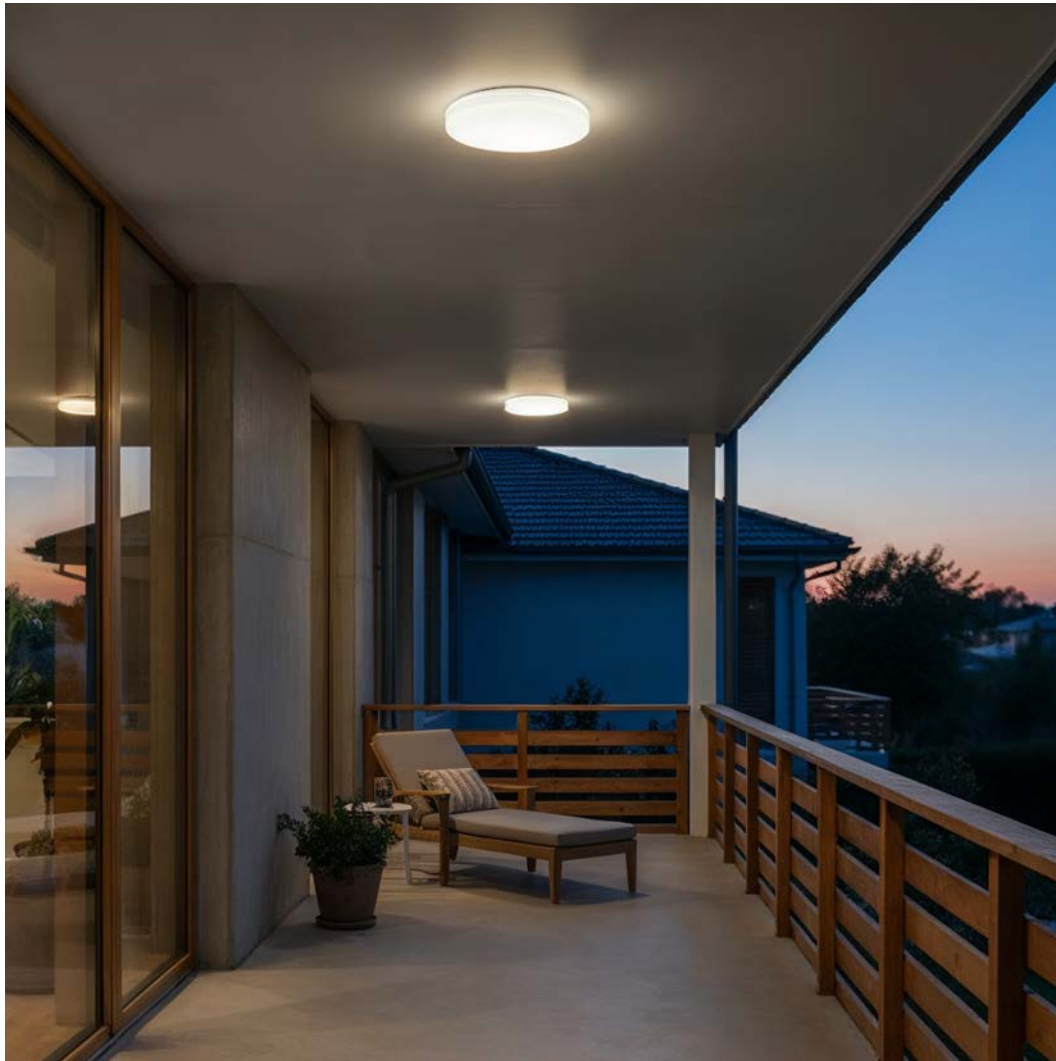

- \_ Plafoniera tonda in policarbonato anti UV, IP54, ideale sia per esterni che per interni
- \_ Di facile installazione a soffitto o a parete grazie ad una staffa di fissaggio in metallo
- \_ CCT selezionabile

- \_ Round anti-UV polycarbonate ceiling light, IP54, ideal for both outdoor and indoor use.
- \_ Easy to install on the ceiling or wall thanks to a metal fixing bracket
- \_ Selectable CCT



W	K	LUMEN APPARECCHIO lm	LUMEN SORGENTE lm		VARIANTE	CODICE	EAN		
24	<input type="checkbox"/> 3000 <input type="checkbox"/> 4200 <input type="checkbox"/> 6500	2400	2700	120°	-	ERIKA24R	8031453025755	1/10	

# ERIKA SQUARED

BTL CATEGORIA SCONTO 23

Plafoniera CCT / CCT ceiling light

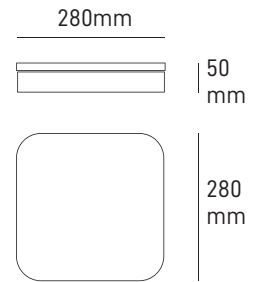

- \_ Plafoniera quadrata in policarbonato anti UV , IP54, ideale sia per esterni che per interni
- \_ Di facile installazione a soffitto o a parete grazie ad una staffa di fissaggio in metallo
- \_ CCT selezionabile

- \_ Squared anti-UV polycarbonate ceiling light , IP54, ideal for both outdoor and indoor use.
- \_ Easy to install on the ceiling or wall thanks to a metal fixing bracket
- \_ Selectable CCT



W	K	LUMEN APPARECCHIO lm	LUMEN SORGENTE lm		VARIANTE	CODICE	EAN		
24	<input type="checkbox"/> 3000 <input type="checkbox"/> 4200 <input type="checkbox"/> 6500	2400	2700	120°	-	ERIKA24Q	8031453025762	1/10	

# NORA ROUND

BTL CATEGORIA SCONTO 23

Plafoniera CCT / CCT ceiling light

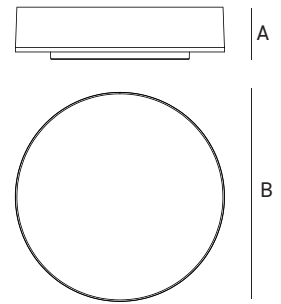

Dimensioni	A	B
1	70	280
2	70	400

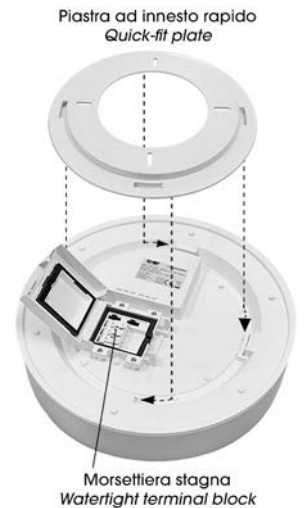

Trasforma l'atmosfera di ogni stanza con l'eleganza minimalista di questa plafoniera il cui design è caratterizzato da linee tese e spigoli vivi.

Transform the atmosphere of any room with the minimalist elegance of this ceiling light, characterized by its clean lines and sharp edges.

- \_ Plafoniera tonda in policarbonato, IP54, ideale sia per esterni che per interni
- \_ Installazione semplificata con base separata e innesto a baionetta
- \_ Potenza selezionabile tramite l'apposito selettore
- \_ CCT selezionabile

- \_ Round polycarbonate ceiling light, IP54, suitable for both outdoor and indoor use
- \_ Simplified installation with separate base and bayonet fitting
- \_ Selectable power via dedicated selector
- \_ Selectable CCT



W	K	LUMEN APPARECCHIO lm	LUMEN SORGENTE lm	MISURE	VARIANTE	CODICE	EAN		
12	3000	1450	1900	125° 1	-	NORA24RK	8031453032364	1/5	A t G D
18	4000	2150	2850						
24	5000	2900	3800						
24	3000	2900	3800	125° 2	-	NORA36RK	8031453034405	1/5	A t G D
30	4000	3600	4750						
36	5000	4400	5700						



**NORA ROUND**

# NORA SQUARED

BTL CATEGORIA SCONTO 23

Plafoniera CCT / CCT ceiling light

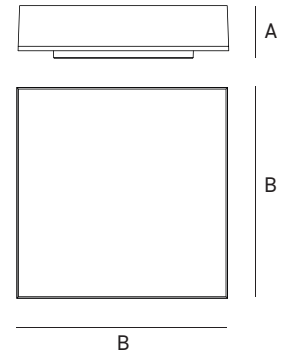

Dimensioni	A	B
1	70	280
2	70	400

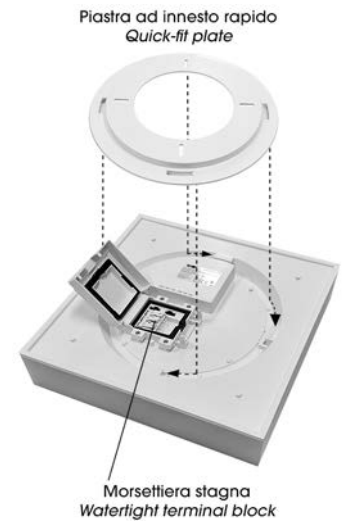

Trasforma l'atmosfera di ogni stanza con l'eleganza minimalista di questa plafoniera il cui design è caratterizzato da linee tese e spigoli vivi.

- \_ Plafoniera quadrata in policarbonato, IP54, ideale sia per esterni che per interni
- \_ Installazione semplificata con base separate e innesto a baionetta
- \_ Potenza selezionabile tramite l'apposito selettore
- \_ CCT selezionabile

*Transform the atmosphere of any room with the minimalist elegance of this ceiling light, characterized by its clean lines and sharp edges.*

- \_ Squared polycarbonate ceiling light, IP54, suitable for both outdoor and indoor use
- \_ Simplified installation with separate base and bayonet fitting
- \_ Selectable power via dedicated selector
- \_ Selectable CCT



W	K	LUMEN APPARECCHIO lm	LUMEN SORGENTE lm	MISURE	VARIANTE	CODICE	EAN		
12	3000	1450	1900	125° 1	-	NORA24QK	8031453032371	1/5	A t G D
18	4000	2150	2850						
24	5000	2900	3800						
24	3000	2900	3800	125° 2	-	NORA36QK	8031453034399	1/5	A t G D
30	4000	3600	4750						
36	5000	4400	5700						



**NORA SQUARED**

# SONO III PIR

Plafoniera PIR / PIR ceiling light

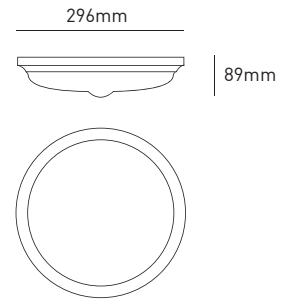

- \_ Plafoniera in policarbonato particolarmente indicata per frequenti accensioni e spegnimenti
- \_ Sensore di presenza PIR con sistema master/slave.
- \_ Pilota fino ad altre due plafoniere SONO III PIR
- \_ Regolazioni del sensore: - Tempo di accensione: 15s - 30min - Distanza di rilevamento: 2-6m - Luminosità ambientale: 2-2000lux
- \_ Altezza di installazione: 2-3 m

- \_ Ceiling light with polycarbonate diffuser particularly recommended for frequent on/off
- \_ PIR presence sensor with master/slave system.
- \_ Drives up to two more SONO III PIR luminaires
- \_ Sensor adjustments: - Light-on time: 15s - 30min - Detection distance: 2-6m - Ambient light level: 2-2000lux
- \_ Installation height: 2-3 m



W	K	LUMEN APPARECCHIO lm		VARIANTE	CODICE	EAN	
15	3500	1500	120°	-	<b>4146957</b>	6435200309181	1/6



**SONO**

# GIADA II

BTL CATEGORIA SCONTO 23

Plafoniera multifunzione ad alta resistenza / High resistance multifunctional ceiling light

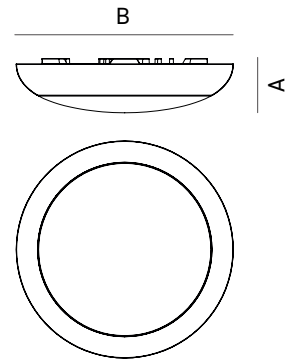

Dimensioni	A	B
1	80	280
2	80	320

- \_ Plafoniera tonda in policarbonato anti UV ideale sia per esterno che per interno
- \_ Protezione all'umidità IP65 e alta resistenza meccanica IK10
- \_ Predisposizione collegamento passante sui lati
- \_ Disponibile variante con modulo emergenza 3h di durata a 150lm
- \_ Disponibile variante con sensore a microonde programmabile mediante dip-switch (sensibilità, livello di luce ambientale, durata, luce di cortesia)
- \_ Potenza e CCT selezionabili
- \_ Cornice bianca in dotazione, opzionale cornice in colore nero

- \_ Round anti-UV polycarbonate ceiling light suitable for both outdoor and indoor use
- \_ IP65 humidity protection and IK10 high mechanical resistance
- \_ Predisposition for through connection on sides
- \_ Available variant with emergency module lasting 3 hours at 150 lumens
- \_ Available variant with microwave sensor programmable via dip-switch (sensitivity, ambient light level, duration, courtesy light)
- \_ Power and CCT selectable
- \_ White frame included, optional black frame available



W	K	LUMEN APPARECCHIO lm	LUMEN SORGENTE lm	MISURE	VARIANTE	CODICE	EAN		
					ON/OFF	<b>GIADAI12K</b>	8031453033835	1/4	A ↑ G D
8	3000	950	1100	120°	EMERGENZA / EMERGENCY <sup>1</sup>	<b>GIADAI12KE</b>	8031453033842	1/4	A ↑ G D
10	4000	1200	1400		SENSORE A MICROONDE / MICROWAVE SENSOR <sup>2</sup>	<b>GIADAI12KS</b>	8031453033859	1/4	A ↑ G D
12	6500	1500	1700		MICROONDE + EMERGENZA / MICROWAVE SENSOR + EMERGENCY <sup>1 2</sup>	<b>GIADAI12KSE</b>	8031453033866	1/4	A ↑ G D
Accessorio GIADA II 280mm Anello decorativo Nero						<b>GIADAI12B</b>	8031453033941	1	
					ON/OFF	<b>GIADAI20K</b>	8031453033873	1/4	A ↑ G D
12	3000	1450	1700	120°	EMERGENZA / EMERGENCY <sup>1</sup>	<b>GIADAI20KE</b>	8031453033880	1/4	A ↑ G D
16	4000	2000	2300		SENSORE A MICROONDE / MICROWAVE SENSOR <sup>2</sup>	<b>GIADAI20KS</b>	8031453033897	1/4	A ↑ G D
20	6500	2500	2800		MICROONDE + EMERGENZA / MICROWAVE SENSOR + EMERGENCY <sup>1 2</sup>	<b>GIADAI20KSE</b>	8031453033903	1/4	A ↑ G D
Accessorio GIADA II 320mm Anello decorativo Nero						<b>GIADAI20B</b>	8031453033934	1	

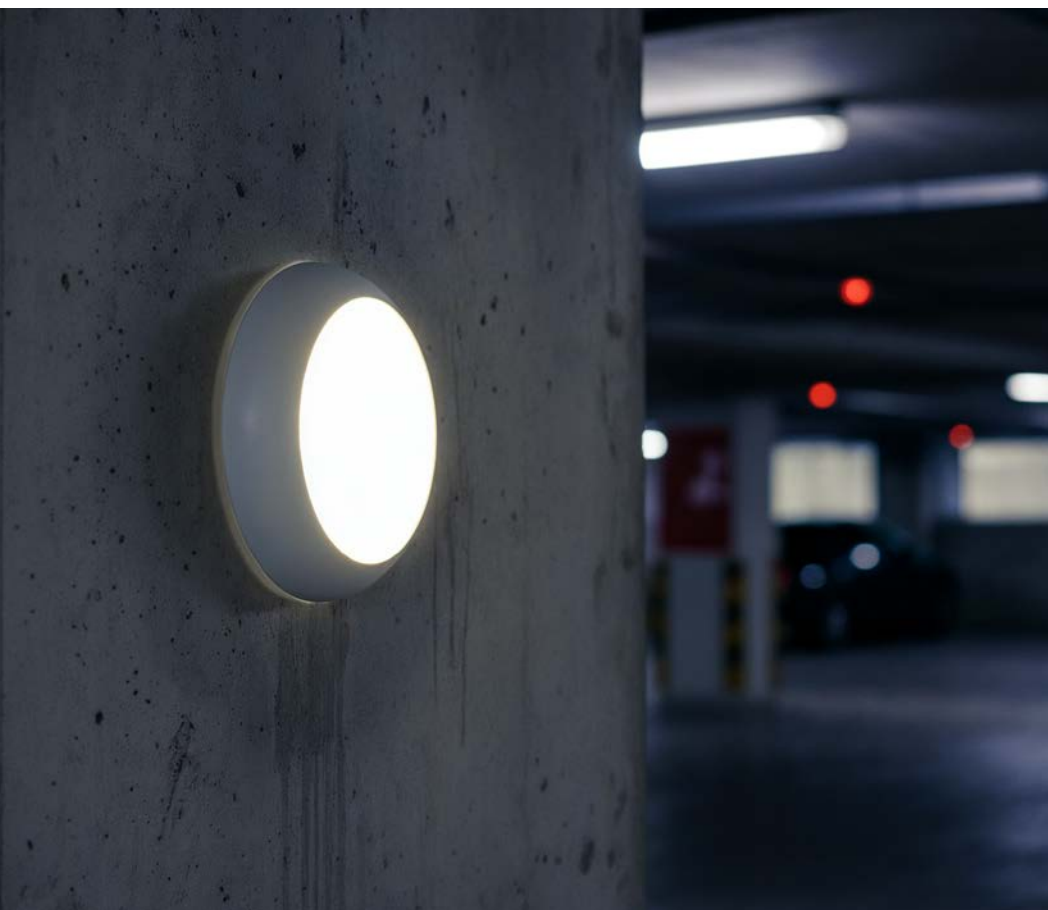

**GIADA II**

# RONDA

BTL CATEGORIA SCONTO 24

Plafoniera CCT / CCT ceiling light

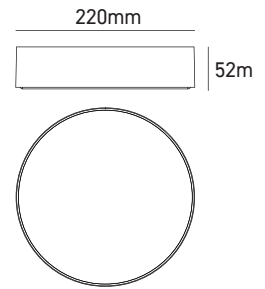

- \_ Plafoniera in alluminio per interni ed esterni
- \_ Modulo LED integrato da 20W
- \_ CCT selezionabile

- \_ Aluminum ceiling light for indoor and outdoor use
- \_ Integrated 20W LED module
- \_ Selectable CCT



W	K	LUMEN APPARECCHIO lm	LUMEN SORGENTE lm		VARIANTE	CODICE	EAN		
20	<input type="checkbox"/> 3000 <input type="checkbox"/> 4000 <input type="checkbox"/> 5000	2000	2800	180°	<input type="checkbox"/> BIANCO / WHITE	<b>RONDA20BK</b>	8031453032395	1/20	
20	<input type="checkbox"/> 3000 <input type="checkbox"/> 4000 <input type="checkbox"/> 5000	1750	2800	180°	<input checked="" type="checkbox"/> ANTRACITE / ANTHRACITE	<b>RONDA20GK</b>	8031453032418	1/20	
20	<input type="checkbox"/> 3000 <input type="checkbox"/> 4000 <input type="checkbox"/> 5000	1700	2800	180°	<input checked="" type="checkbox"/> CORTEN	<b>RONDA20CK</b>	8031453032401	1/20	

# RONDA BIG NEW

BTL CATEGORIA SCONTO 24

Plafoniera CCT / CCT ceiling light

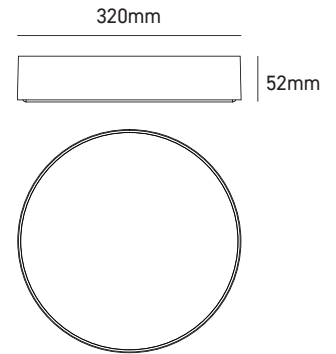

- \_ Plafoniera in alluminio per interni ed esterni
- \_ Modulo LED integrato da 30W
- \_ CCT selezionabile

- \_ Aluminum ceiling light for indoor and outdoor use
- \_ Integrated 30W LED module
- \_ Selectable CCT



W	K	LUMEN APPARECCHIO lm	LUMEN SORGENTE lm		VARIANTE	CODICE	EAN		
30	<input type="checkbox"/> 3000 <input type="checkbox"/> 4000 <input type="checkbox"/> 5000	3500	4000	180°	<input type="checkbox"/> BIANCO / WHITE	<b>RONDA30BK</b>	8031453035778	1/5	
30	<input type="checkbox"/> 3000 <input type="checkbox"/> 4000 <input type="checkbox"/> 5000	3350	4000	180°	<input checked="" type="checkbox"/> ANTRACITE / ANTHRACITE	<b>RONDA30GK</b>	8031453035792	1/5	
30	<input type="checkbox"/> 3000 <input type="checkbox"/> 4000 <input type="checkbox"/> 5000	3400	4000	180°	<input checked="" type="checkbox"/> CORTEN	<b>RONDA30CK</b>	8031453035785	1/5	

# SONJA

BTL CATEGORIA SCONTO 23

Plafoniera / Ceiling light

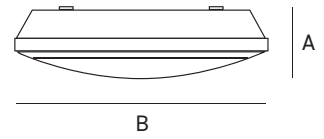

Dimensioni	A	B
1	100	300
2	118	355



Questa plafoniera robusta e di dimensione generosa, illumina ogni ambiente in modo efficiente e pratico. Perfetta per chi cerca qualità e durata.

- \_ Plafoniera tonda in policarbonato anti UV ideale sia per esterno che per interno
- \_ Protezione all'umidità IP65 e alta resistenza meccanica IK10
- \_ Installazione rapida a parete o a soffitto grazie alle clip di fissaggio
- \_ Attacco E27 sorgenti LED max 2x20W per SONJAE27x
- \_ Attacco E27 sorgenti LED max 3x20W per SONJA3E27B

*This sturdy and generously sized ceiling light illuminates any room efficiently and practically. Perfect for those looking for quality and durability.*

- \_ *Round ceiling light in anti-UV PC ideal for both outdoor and indoor use*
- \_ *IP65 humidity protection and IK10 high mechanical resistance*
- \_ *Quick wall or ceiling installation thanks to the fixing clips.*
- \_ *E27 base for LED light sources max 2x20W for SONJAE27x*
- \_ *E27 base for LED light sources max 3x20W for SONJA3E27B*



BASE		MISURE	VARIANTE	CODICE	EAN	
E27	-	1	<input type="checkbox"/> BIANCO / WHITE	<b>SONJAE27B</b>	8031453029432	1/6
E27	-	1	<input checked="" type="checkbox"/> NERO / BLACK	<b>SONJAE27N</b>	8031453031428	1/6
E27	-	2	<input type="checkbox"/> BIANCO / WHITE	<b>SONJA3E27B</b>	8031453032548	1/6

## SONJA OVAL

BTL CATEGORIA SCONTO 23

Plafoniera / Ceiling light

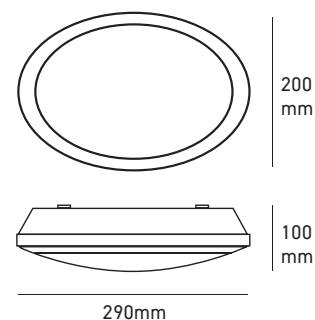

Plafoniera ovale elegante e robusta, perfetta per illuminare ogni ambiente in modo efficace, garantendo durata e versatilità.

- \_ Plafoniera ovale in policarbonato anti UV ideale sia per esterno che per interno
- \_ Protezione all'umidità IP65 e alta resistenza meccanica IK10
- \_ Installazione rapida a parete o a soffitto grazie alle clip di fissaggio
- \_ Attacco E27 per sorgenti LED max 20W

*Elegant and robust oval ceiling light, perfect for effectively illuminating any room, ensuring durability and versatility.*

- \_ *Oval ceiling light in anti-UV PC ideal for both outdoor and indoor use*
- \_ *IP65 humidity protection and IK10 high mechanical resistance*
- \_ *Quick wall or ceiling installation thanks to the fixing clips.*
- \_ *E27 base for LED light sources max 20W*



BASE		VARIANTE	CODICE	EAN	
E27	-	<input type="checkbox"/> BIANCO / WHITE	SONJA1E27B	8031453032524	1/12
E27	-	<input checked="" type="checkbox"/> NERO / BLACK	SONJA1E27N	8031453032531	1/12

# OVIEDO ROUND

BTL CATEGORIA SCONTO 23

Plafoniera CCT / CCT ceiling light

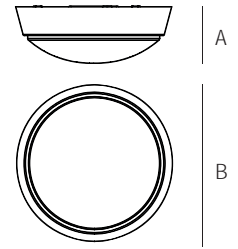

Dimensioni	A	B
1	68	180
2	78	220



- \_ Plafoniera tonda con diffusore in policarbonato ideale sia per esterno che per interno
- \_ Installazione sia a parete che a soffitto
- \_ Disponibile anche in variante con sensore crepuscolare con soglia di intervento sotto i 30lux
- \_ CCT selezionabile
- \_ Anello bianco e nero in dotazione

- \_ Round ceiling light with polycarbonate diffuser, ideal for both outdoor and indoor use
- \_ Wall or ceiling installation
- \_ Available with dusk sensor with intervention below 30lux
- \_ Selectable CCT
- \_ White and black rings included



W	K	LUMEN APPARECCHIO lm	LUMEN SORGENTE lm	MISURE	VARIANTE	CODICE	EAN			
15	3000	1550	2000	120°	1	-	OVIEDO15R	8031453025663	1/20	
	4200									
	6500									
15	3000	1550	2000	120°	1	SENSORE CREPUSCOLARE / DUSK SENSOR *	OVIEDO15RS	8031453025700	1/20	
	4200									
	6500									
24	3000	2350	2900	120°	2	-	OVIEDO24R	8031453025670	1/20	
	4200									
	6500									

# OVIEDO OVAL AGGIORNATO

BTL CATEGORIA SCONTO 23

Plafoniera CCT / CCT ceiling light

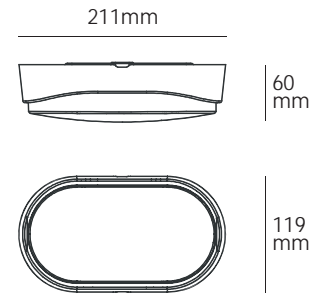

Accessori inclusi  
Accessories included

- Plafoniera ovale con diffusore in policarbonato ideale sia per esterno che per interno
  - Installazione sia a parete che a soffitto
  - Disponibile nelle varianti ON/OFF, con sensore crepuscolare con soglia di intervento 30lux o con sensore PIR
  - CCT selezionabile
  - Anello bianco e nero in dotazione
- *Oval ceiling light with polycarbonate diffuser, ideal for both outdoor and indoor use*
  - *Wall or ceiling installation*
  - *Available in ON/OFF version, with dusk sensor (30lux threshold) or with PIR sensor*
  - *Selectable CCT*
  - *White and black rings included*

IP 65

IK 08

220-240V

<sup>1</sup> AUTOMATIC ON-OFF

<sup>2</sup> PIR

W	K	LUMEN APPARECCHIO lm	LUMEN SORGENTE lm		VARIANTE	CODICE	EAN			
15	<span style="background-color: #ffc000; width: 10px; height: 10px; display: inline-block;"></span> 3000	1550	2000	120°	-	OVIEDO150	8031453025687	1/20		
	<span style="background-color: #fff; width: 10px; height: 10px; display: inline-block;"></span> 4200									
	<span style="background-color: #add8e6; width: 10px; height: 10px; display: inline-block;"></span> 6500									
15	<span style="background-color: #ffc000; width: 10px; height: 10px; display: inline-block;"></span> 3000	1550	2000	120°	SENSORE CREPUSCOLARE / DUSK SENSOR <sup>1</sup>	OVIEDO150S	8031453025717	1/20		
	<span style="background-color: #fff; width: 10px; height: 10px; display: inline-block;"></span> 4200									
	<span style="background-color: #add8e6; width: 10px; height: 10px; display: inline-block;"></span> 6500									
15	<span style="background-color: #ffc000; width: 10px; height: 10px; display: inline-block;"></span> 3000	1550	2000	120°	SENSORE CREPUSCOLARE E MOVIMENTO / DUSK AND PIR SENSOR <sup>1 2</sup>	OVIEDO150PIR	8031453035105	1/20		
	<span style="background-color: #fff; width: 10px; height: 10px; display: inline-block;"></span> 4200									
	<span style="background-color: #add8e6; width: 10px; height: 10px; display: inline-block;"></span> 6500									
18	<span style="background-color: #ffc000; width: 10px; height: 10px; display: inline-block;"></span> 3000	1750	2350	120°	-	OVIEDO180	8031453025694	1/20		
	<span style="background-color: #fff; width: 10px; height: 10px; display: inline-block;"></span> 4200									
	<span style="background-color: #add8e6; width: 10px; height: 10px; display: inline-block;"></span> 6500									

NEW

# BURGOS

BTL CATEGORIA SCONTO 24

Plafoniera CCT / CCT ceiling light

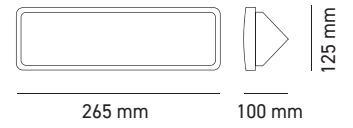

Plafoniera per esterni a led integrato ad alta emissione caratterizzata da luce diffusa a 45°.

- \_ Plafoniera in policarbonato, protezione IP65, ideale sia per esterno che per interno
- \_ Di facile installazione
- \_ CCT selezionabile

Outdoor ceiling light with integrated high-output LED, featuring 45° diffused lighting.

- \_ Polycarbonate ceiling light, IP65, ideal for both outdoor and indoor use
- \_ Easy to install
- \_ Selectable CCT



W	K	LUMEN APPARECCHIO lm	LUMEN SORGENTE lm		VARIANTE	CODICE	EAN		
12	<input type="checkbox"/> 3000 <input type="checkbox"/> 4000 <input type="checkbox"/> 6000	1320	1900	120°	<input type="checkbox"/> BIANCO / WHITE	<b>BURGOS12BK</b>	8031453032555	1/32	
12	<input type="checkbox"/> 3000 <input type="checkbox"/> 4000 <input type="checkbox"/> 6000	1320	1900	120°	<input checked="" type="checkbox"/> NERO / BLACK	<b>BURGOS12NK</b>	8031453032562	1/32	



**BURGOS**





**TECNICO / PANNELLI LED**  
TECHNICAL / LED PANELS

# PANNELLO LED BACKLIT 600X600 ALTA EFFICIENZA

## 600X600 HIGH EFFICIENCY BACKLIT LED PANEL

BTL CATEGORIA  
SCONTO 23

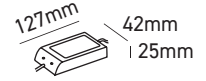
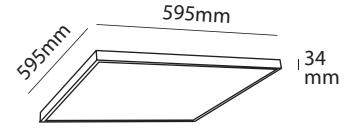

Driver compreso nella confezione  
Driver included

- \_ Pannello LED retroilluminato, non necessita di LGP
- \_ Alta efficienza 140lm/W
- \_ Protezione frontale IP40, posteriore IP20
- \_ Cornice in alluminio verniciato bianco RAL9016
- \_ In opzione driver dimmerabile DALI-Push
- \_ In opzione kit di emergenza con connettore DC
- \_ In opzione kit di montaggio a plafone, sospensione ed incasso

- \_ Backlit LED panel, LGP not required
- \_ 140lm/W high efficiency
- \_ IP40 front / IP20 rear protection
- \_ RAL9016 white painted finish aluminium frame
- \_ Optional: DALI-Push dimmable driver
- \_ Optional: emergency kit with DC connector
- \_ Optional: surface mounting, suspension or recessed KIT



W	K	LUMEN APPARECCHIO lm	LUMEN SORGENTE lm		VARIANTE	CODICE	EAN			
25		4000	3500	4000	120°	-	LD4PAN2553H	8031453027759	1/4	
25		4000	3500	4000	90°	UGR<19 *	LD4PAN2553HU	8031453027766	1/4	

# PANNELLO LED BACKLIT 600X600 ALTA EMISSIONE

## 600X600 HIGH EMISSION BACKLIT LED PANEL

BTL CATEGORIA  
SCONTO 23

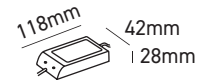
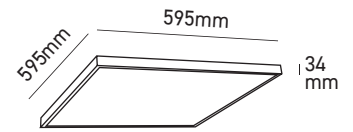

Driver compreso nella confezione  
Driver included

- \_ Pannello LED retroilluminato, non necessita di LGP
- \_ Alta efficienza 170lm/W
- \_ Protezione frontale IP40, posteriore IP20
- \_ Driver Philips a lunga durata: 50.000h
- \_ Cornice in alluminio verniciato bianco RAL9016
- \_ In opzione kit di emergenza con connettore DC
- \_ In opzione kit di montaggio a plafone, sospensione ed incasso

- \_ Backlit LED panel, LGP not required
- \_ 170lm/W high efficiency
- \_ IP40 front / IP20 rear protection
- \_ 50.000h long lifespan Philips driver
- \_ RAL9016 white painted finish aluminium frame
- \_ Optional: emergency kit with DC connector
- \_ Optional: surface mounting, suspension or recessed KIT



W	K	LUMEN APPARECCHIO lm	LUMEN SORGENTE lm		VARIANTE	CODICE	EAN			
36		4000	5000	6250	110°	-	<b>LD4PAN5053</b>	8031453034276	1/4	
36		4000	5000	6500	90°	UGR<19 <sup>2</sup>	<b>LD4PAN5053U</b>	8031453034283	1/4	
36		4000	5000	6250	110°	DALI/PUSH <sup>1</sup>	<b>LD4PAN5053D</b>	8031453034474	1/4	
36		4000	5000	6500	90°	UGR<19 - DALI/PUSH <sup>1 2</sup>	<b>LD4PAN5053UD</b>	8031453034481	1/4	

# PANNELLO LED BACKLIT 600X600

## 600X600 BACKLIT LED PANEL

BTL CATEGORIA  
SCONTO 23

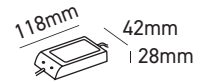
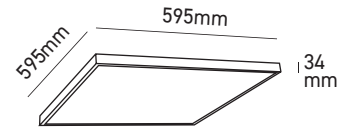
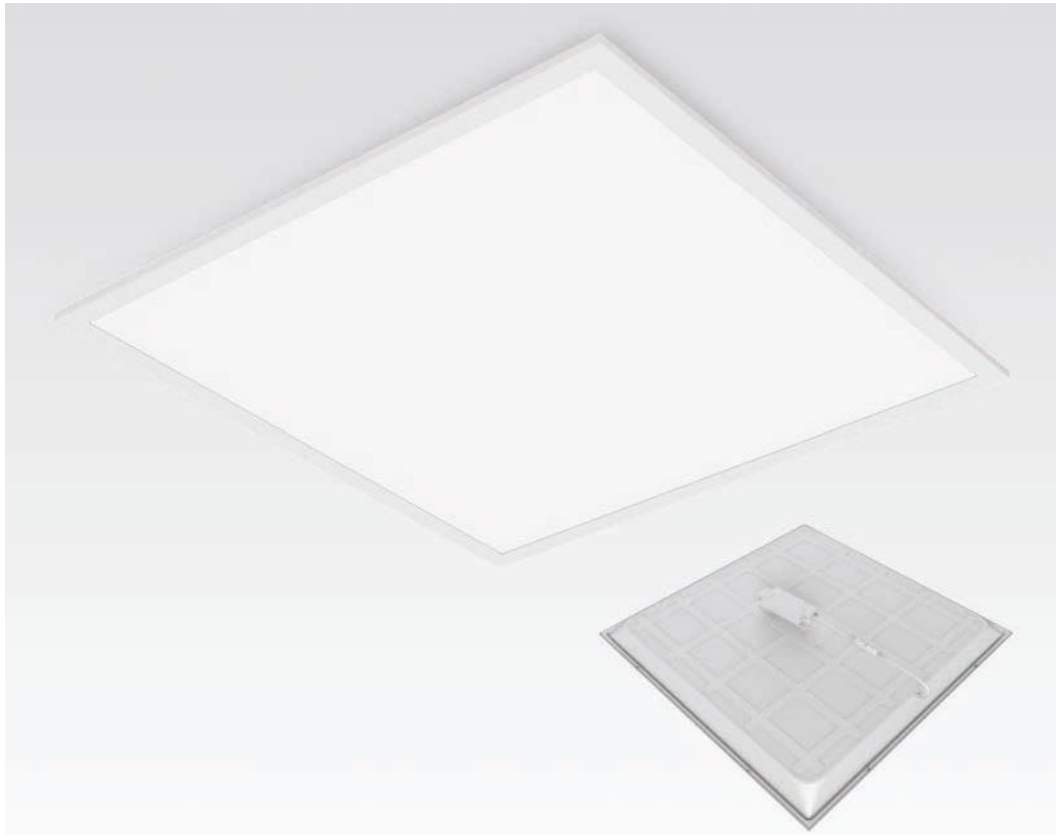

Driver compreso nella confezione  
Driver included

- \_ Pannello LED retroilluminato, non necessita di LGP
- \_ Protezione frontale IP40, posteriore IP20
- \_ Driver Philips a lunga durata: 50.000h
- \_ Cornice in alluminio verniciato bianco RAL9016
- \_ In opzione kit di emergenza con connettore DC
- \_ In opzione kit di montaggio a plafone, sospensione ed incasso

- \_ Backlit LED panel, LGP not required
- \_ IP40 front / IP20 rear protection
- \_ 50.000h long lifespan Philips driver
- \_ RAL9016 white painted finish aluminium frame
- \_ Optional: emergency kit with DC connector
- \_ Optional: surface mounting, suspension or recessed KIT



W	K	LUMEN APPARECCHIO lm	LUMEN SORGENTE lm		VARIANTE	CODICE	EAN		
36	3000	3600	4300	110°	-	LD4PAN3652-2	8031453033330	1/4	A ↑ G E
36	4000	3600	4500	110°	-	LD4PAN3653-2	8031453033347	1/4	A ↑ G E
36	4000	3600	4500	90°	UGR<19 <sup>3</sup>	LD4PAN3653U-2	8031453033354	1/4	A ↑ G E
36	4000	3600	4500	90°	CRI>90 - UGR<19 <sup>2,3</sup>	LD4PAN3653U9-2	8031453034290	1/4	A ↑ G E
36	3000	3600	4300	110°	DALI/PUSH <sup>1</sup>	LD4PAN3652-2D	8031453034238	1/4	A ↑ G E
36	4000	3600	4500	110°	DALI/PUSH <sup>1</sup>	LD4PAN3653-2D	8031453034245	1/4	A ↑ G E
36	4000	3600	4500	90°	UGR<19 - DALI/PUSH <sup>1,3</sup>	LD4PAN3653U-2D	8031453034252	1/4	A ↑ G E
36	4000	3600	4500	90°	CRI>90 - UGR<19 - DALI/PUSH <sup>1,2,3</sup>	LD4PAN3653U9-2D	8031453034443	1/4	A ↑ G E

# PANNELLO LED BACKLIT 600X600 - VALUE 4PACK

## 600X600 BACKLIT LED PANEL - VALUE 4PACK

BTL CATEGORIA  
SCONTO 23

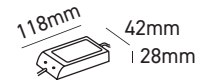
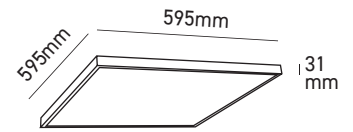

Driver compreso nella confezione  
Driver included



- \_ Pannello LED retroilluminato, non necessita di LGP
- \_ Protezione frontale IP40, posteriore IP20
- \_ Cornice in alluminio verniciato bianco RAL9016
- \_ In opzione driver dimmerabile DALI-Push
- \_ In opzione kit di emergenza con connettore DC
- \_ In opzione kit di montaggio a plafone, sospensione ed incasso
- \_ Confezione da 4 pannelli (1 pezzo corrisponde a 4 pannelli)

- \_ Backlit LED panel, LGP not required
- \_ IP40 front / IP20 rear protection
- \_ RAL9016 white painted finish aluminium frame
- \_ Optional: DALI-Push dimmable driver
- \_ Optional: emergency kit with DC connector
- \_ Optional: surface mounting, suspension or recessed KIT
- \_ Pack of 4 panels (1 piece corresponds to 4 panels)



W	K	LUMEN APPARECCHIO lm	LUMEN SORGENTE lm		VARIANTE	CODICE	EAN			
36		3000	3600	3800	120°	-	LD4PAN3652V-2	8031453033309	1 (4pz)	
36		4000	3600	4100	120°	-	LD4PAN3653V-2	8031453033316	1 (4pz)	
36		4000	3600	4300	90°	UGR<19 *	LD4PAN3653VU-2	8031453033323	1 (4pz)	

# PANNELLO LED BACKLIT 300X1200

## 300X1200 BACKLIT LED PANEL

BTL CATEGORIA  
SCONTO 23

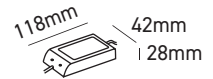
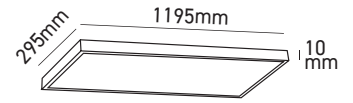

Driver compreso nella confezione  
Driver included

- \_ Pannello LED retroilluminato, non necessita di LGP
- \_ Protezione frontale IP40, posteriore IP20
- \_ Driver Philips a lunga durata: 50.000h
- \_ Cornice in alluminio verniciato bianco RAL9016
- \_ In opzione kit di emergenza con connettore DC
- \_ In opzione kit di montaggio a plafone, sospensione ed incasso

- \_ Backlit LED panel, LGP not required
- \_ IP40 front / IP20 rear protection
- \_ 50.000h long lifespan Philips driver
- \_ RAL9016 white painted finish aluminium frame
- \_ Optional: emergency kit with DC connector
- \_ Optional: surface mounting, suspension or recessed KIT



W	K	LUMEN APPARECCHIO lm	LUMEN SORGENTE lm		VARIANTE	CODICE	EAN		
36	<input type="checkbox"/> 4000	3600	4300	110°	-	LD4PAN3653B-2	8031453034429	1/4	
36	<input type="checkbox"/> 4000	3600	4500	90°	CRI>90 - UGR<19 <sup>23</sup>	LD4PAN3653UB9-2	8031453034306	1/4	
36	<input type="checkbox"/> 4000	3600	4300	110°	DALI/PUSH <sup>1</sup>	LD4PAN3653B-2D	8031453034450	1/4	
36	<input type="checkbox"/> 4000	3600	4500	90°	CRI>90 - UGR<19 - DALI/PUSH <sup>123</sup>	LD4PAN3653UB9-2D	8031453034467	1/4	

# PANNELLO LED EDGELIT 600X600

## 600X600 EDGELIT LED PANEL

BTL CATEGORIA  
SCONTO 23

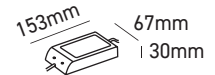
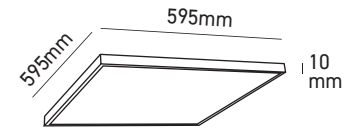

Driver compreso nella confezione  
Driver included

- \_ Pannello LED spessore 10mm ad illuminazione laterale
- \_ LGP in PMMA anti ingiallimento per la versione 45W
- \_ Protezione frontale IP40, posteriore IP20
- \_ Cornice in alluminio verniciato bianco RAL9016
- \_ In opzione driver dimmerabile DALI-Push
- \_ In opzione kit di emergenza con connettore DC
- \_ In opzione kit di montaggio a plafone, sospensione ed incasso

- \_ 10mm-thick LED panel with side lighting
- \_ Anti-yellowing PMMA LGP for the 45W version
- \_ IP40 front / IP20 rear protection
- \_ RAL9016 white painted finish aluminium frame
- \_ Optional: DALI-Push dimmable driver
- \_ Optional: emergency kit with DC connector
- \_ Optional: surface mounting, suspension or recessed KIT



W	K	LUMEN APPARECCHIO lm	LUMEN SORGENTE lm		VARIANTE	CODICE	EAN			
38		3000	3800	5000	110°	-	LD3PAN3852	8031453021740	1/6	
38		4000	3800	5000	110°	-	LD3PAN3853	8031453021757	1/6	
38		6500	3800	5000	110°	-	LD3PAN3851	8031453024697	1/6	
38		4000	3800	5000	90°	UGR<19 <sup>1</sup>	LD3PAN3853U	8031453021771	1/6	
38		3000	3200	4600	90°	CRI>90 - UGR<19 <sup>1 2</sup>	LD3PAN3852U9	8031453022952	1/6	
38		4000	3400	4900	90°	CRI>90 - UGR<19 <sup>1 2</sup>	LD3PAN3853U9	8031453022969	1/6	
45		3000	5000	6800	90°	UGR<19 <sup>1</sup>	LD3PAN4552U	8031453022631	1/6	
45		4000	5000	6900	90°	UGR<19 <sup>1</sup>	LD3PAN4553U	8031453022648	1/6	

# PANNELLO LED EDGELIT 300X1200

## 300X1200 EDGELIT LED PANEL

BTL CATEGORIA  
SCONTO 23

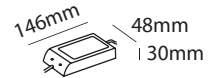
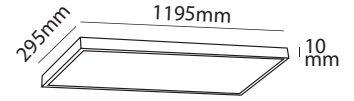

Driver compreso nella confezione  
Driver included

- \_ Pannello LED spessore 10mm ad illuminazione laterale
- \_ Protezione frontale IP40, posteriore IP20
- \_ Cornice in alluminio verniciato bianco RAL9016
- \_ In opzione driver dimmerabile DALI-Push
- \_ In opzione kit di emergenza con connettore DC
- \_ In opzione kit di montaggio a plafone, sospensione ed incasso

- \_ 10mm-thick LED panel with side lighting
- \_ IP40 front / IP20 rear protection
- \_ RAL9016 white painted finish aluminium frame
- \_ Optional: DALI-Push dimmable driver
- \_ Optional: emergency kit with DC connector
- \_ Optional: surface mounting, suspension or recessed KIT



W	K	LUMEN APPARECCHIO lm	LUMEN SORGENTE lm		VARIANTE	CODICE	EAN		
38	<input type="checkbox"/> 4000	3800	5000	110°	-	<b>LD3PAN3853B</b>	8031453021764	1/6	
40	<input type="checkbox"/> 4000	3400	4900	90°	CRI>90 - UGR<19 *	<b>LD3PAN3853UB9</b>	8031453025045	1/6	



**LED DRIVER CORRENTE COSTANTE PER LED PANEL**  
 CONSTANT CURRENT LED DRIVER FOR LED PANEL

Dimensioni DRIVER	A	B	C
1	146	48	30
2	153	57	30
3	136	63	31
4	118	42	28

POTENZA Watt		MISURE mm	VARIANTE	CODICE	EAN	IMBALLO
38		1	-	LD3PAND38	8031453022792	1/10
40		1	-	LD3PAND40	8031453025274	1/10
45		2	-	LD3PAND45	8031453022785	1/10
42 MAX	DIMMABLE	3	1-10V	LD3PAND42D	8031453021801	1/10
36		4	-	LD4PAND36-2	8031453033293	1/10

BTL CATEGORIA SCONTO 23

**KIT MONTAGGIO A SOSPENSIONE**  
 SUSPENDED MOUNTING KIT

CODICE	EAN	IMBALLO
LD3PANCAB	8031453021795	1

Cavo lungo / cable length: 800 mm



CODICE	EAN	IMBALLO
LD4PANCAB	8031453022563	1

Cavo lungo / cable length: 1500 mm

BTL CATEGORIA SCONTO 23

BTL CATEGORIA SCONTO 23

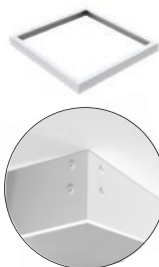
**KIT UNIVERSALE MONTAGGIO A PLAFONE**  
**ASSEMBLAGGIO CON VITI**  
 UNIVERSAL CEILING MOUNTING KIT  
 ASSEMBLY WITH SCREWS

CODICE	MISURE mm	EAN	IMBALLO
LD2PANFRM-2	600x600x55	8031453017682	1
LD2PANFRM-2B	300x1200x55	8031453017705	1

**KIT UNIVERSALE MONTAGGIO A PLAFONE**  
**ASSEMBLAGGIO AD INCASTRO**  
 UNIVERSAL CEILING MOUNTING KIT  
 INTERLOCKING ASSEMBLY

CODICE	MISURE mm	EAN	IMBALLO
LD4PANFRM	600x600x43	8031453022570	1
LD4PANFRMH	600x600x67	8031453027353	1
LD4PANFRMB	300x1200x43	8031453022587	1
LD4PANFRMHB	300x1200x67	8031453034436	1

BTL CATEGORIA SCONTO 23

BTL CATEGORIA SCONTO 23

**KIT MONTAGGIO AD INCASSO CON MOLLE**  
 RECESS MOUNTING KIT WITH SPRINGS

CODICE	EAN	IMBALLO
LD3PANSPG	8031453021818	1

**KIT UNIVERSALE MONTAGGIO AD INCASSO**  
**CON CORNICE**  
 UNIVERSAL RECESSED MOUNTING KIT WITH  
 FRAME

CODICE	MISURE mm	EAN	IMBALLO
LD3PANINK	600x600	8031453022921	1
LD3PANINKB	300x1200	8031453022938	1

	LD3PAN3851 LD3PAN3852 LD3PAN3853 LD3PAN3853U LD3PAN3852U9 LD3PAN3853U9	LD3PAN3853B	LD3PAN3853UB9	LD3PAN4552U LD3PAN4553U	LD4PAN2553H LD4PAN2553HU	LD4PAN3652-2 / D LD4PAN3653-2 / D LD4PAN3653U-2 / D LD4PAN3652V-2 / D LD4PAN3653V-2 / D LD4PAN3653VU-2 / D LD4PAN3653U9-2 / D	LD4PAN3653B-2 / D LD4PAN3653UB9-2 / D	LD4PAN5053 / D LD4PAN5053U / D	
<b>DRIVERS RICAMBIO</b>	LD3PAND38	X	X						
	LD3PAND40			X					
	LD3PAND45				X				
	LD4PAND36-2					X	X	X	
<b>DRIVERS DIM</b>	LD3PAND42D	X	X	X	X				
	MFD-600-42-D				X				
	MFD-1050-42-D	X	X	X	X	X	X	X	
<b>KIT EM</b>	EMK3-60-49-A	X	X	X	X	X	X	X	
<b>KIT SOSPENSIONE</b>	LD3PANCAB	X	X	X	X				
	LD4PANCAB				X	X	X	X	
<b>KIT PLAFONE</b>	LD2PANFRM-2	X			X				
	LD2PANFRM-2B		X	X					
	LD4PANFRM	X			X				
	LD4PANFRMB		X	X					
	LD4PANFRMH	X			X	X	X		X
	LD4PANFRMHB		X	X				X	
<b>KIT INCASSO</b>	LD3PANSPG	X	X	X	X				
	LD3PANINK	X			X	X		X	
	LD3PANINKB		X	X			X		

# DRIVER MULTIFUNZIONE DALI 2/PUSH/0-10V

## DALI 2/PUSH/0-10V MULTIFUNCTION DRIVER

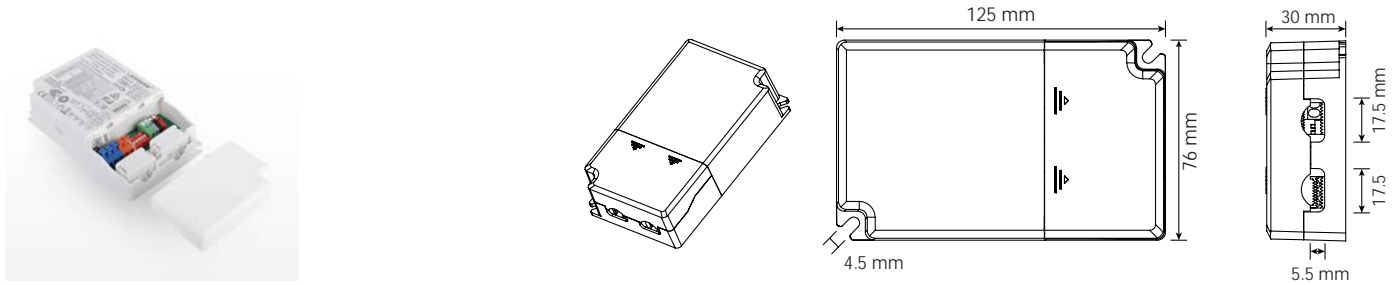

- \_ DRIVER a corrente costante utilizzabile con apparecchi LED dotati di alimentatore esterno (es LED panel o Downlights)
- \_ DRIVER Multifunzione: DALI 2 (IEC 62386-101-102-207), PUSH DIM, 0-10V, 10V PWM
- \_ Flicker-free < 3%
- \_ Corrente di output selezionabile mediante dip-switch
- \_ Marchio ENEC
- \_ Isolamento Classe II, SELV secondo EN 61347
- \_ Tensione in uscita 14-42V
- \_ Vita nominale 50.000 ore
- \_ Range di dimmerazione:
  - DALI 1%-100%
  - Push-DIM 2%-100%
  - 0-10V: 10%-100%
- \_ Fattore di potenza > 0.95 a piena potenza

- \_ Constant current DRIVER usable with LED luminaires equipped with external power supply (e.g. LED panel or Downlights)
- \_ Multifunction DRIVER: DALI 2 control (IEC 62386-101-102-207), PUSH DIM, 0-10V, 10V PWM
- \_ Flicker percentage <3%
- \_ Output current selectable via dip-switch
- \_ ENEC brand
- \_ Class II insulation, SELV according to EN 61347
- \_ Output voltage 14-42V
- \_ Rated lifetime 50,000 hours
- \_ Dimming range:
  - DALI 1% -100%
  - Push-DIM 2% -100%
  - 0-10V: 10% -100%
- \_ Power factor > 0.95 at full power

POTENZA Watt	VARIANTE	CODICE	EAN	IMBALLO
25 max	Dimmable Driver DALI/Push. 250-600mA, 14-42V	MFD-600-42-D	8031453023003	1/10

### DALI SETTINGS

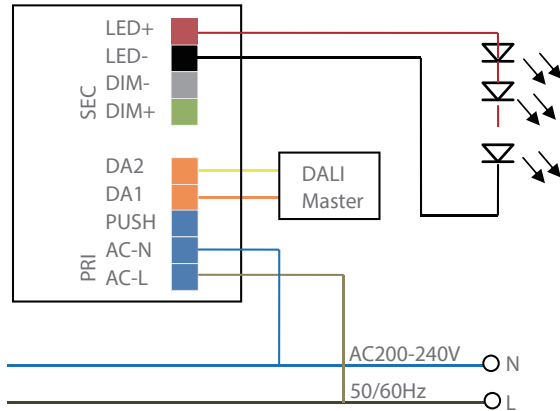

### 0-10V / 10V PWM

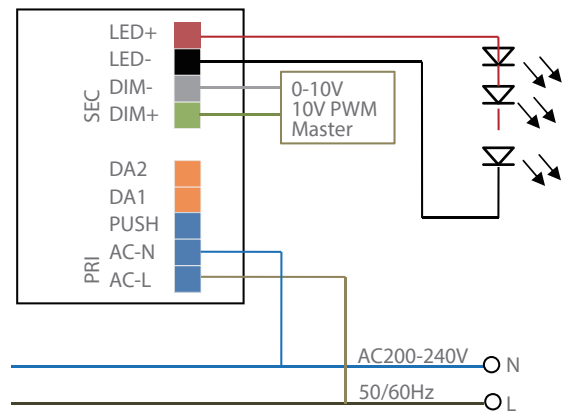

### PUSH

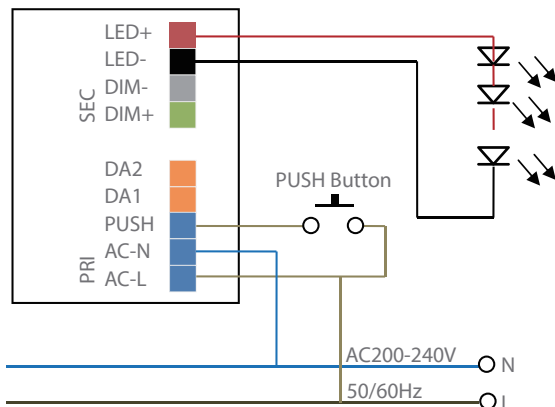

Vo DC	Io DC	Pout	1	2	3
14-42V	250mA	10.5W	OFF	OFF	OFF
	300mA	12.6W	ON	OFF	OFF
	350mA	14.7W	OFF	ON	OFF
	400mA	16.8W	ON	ON	OFF
	450mA	18.9W	OFF	OFF	ON
	500mA	21.0W	ON	OFF	ON
	550mA	23.1W	OFF	ON	ON
	600mA	25.2W	ON	ON	ON

# DRIVER MULTIFUNZIONE DALI 2/PUSH

## DALI 2/PUSH MULTIFUNCTION DRIVER

BTL CATEGORIA SCONTO 23

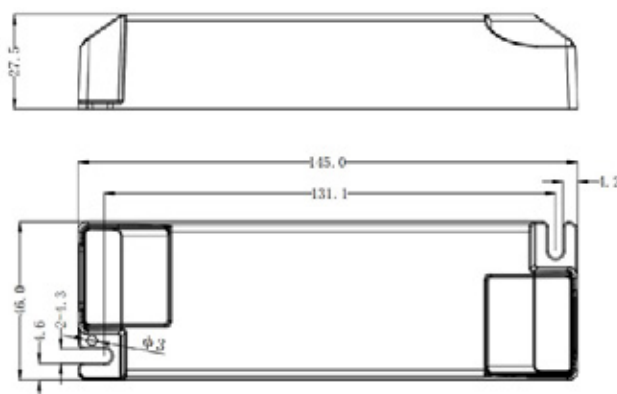

- Driver a corrente costante utilizzabile con apparecchi LED dotati di alimentatore esterno (es LED panel o Downlights)
- Driver multifunzione: DALI 2.0 (IEC 62386-101-102-207), PUSH DIM
- Flicker-free
- Corrente di output selezionabile mediante dip-switch
- Tensione in uscita 9-42V
- Isolamento Classe II, SELV secondo EN 61347
- Vita nominale 50.000 ore
- Range di dimmerazione:
  - DALI 1%-100%
  - Push-DIM 1%-100%
- Fattore di potenza > 0.97 a piena potenza

- Constant current driver suitable with external power supply LED luminaires (e.g. LED panel or Downlights)
- Multifunction driver: DALI 2.0 control (IEC 62386-101-102-207), PUSH DIM
- Flicker free
- Output current selectable via dip-switch
- Output voltage 9-42V
- Class II insulation, SELV according to EN 61347
- Rated lifetime 50,000 hours
- Dimming range:
  - DALI 1% -100%
  - Push-DIM 1% -100%
- Power factor > 0.97 at full power

POTENZA Watt	VARIANTE	CODICE	EAN	IMBALLO
42 max	Dimmable Driver DALI/Push. 700-1050mA, 9-42V	MFD-1050-42-D	8031453034665	1/10

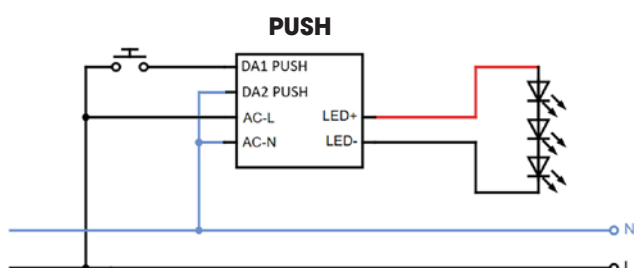
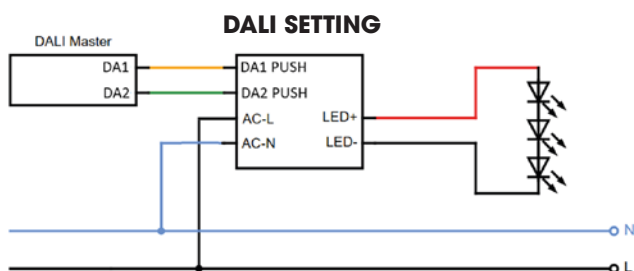

Vo DC	Io DC	Pout	1	2	3
9-42V	700mA	29,4W	ON	ON	ON
	750mA	31,5W	ON	ON	OFF
	800mA	33,6W	ON	OFF	ON
	850mA	35,7W	ON	OFF	OFF
	900mA	37,8W	OFF	ON	ON
	950mA	39,9W	OFF	ON	OFF
9-40V	1000mA	42W	OFF	OFF	ON
	1050mA	42W	OFF	OFF	OFF

# KIT EMERGENZA MULTIFUNZIONE

## MULTIFUNCTIONAL EMERGENCY KIT

BTL CATEGORIA SCONTO 23

NEW

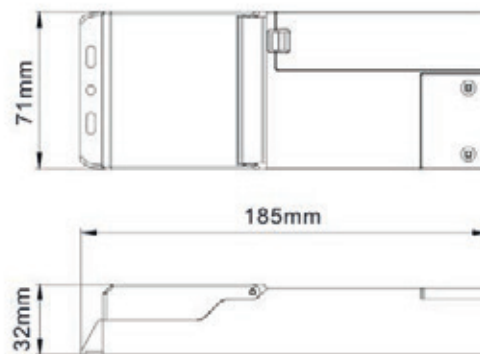
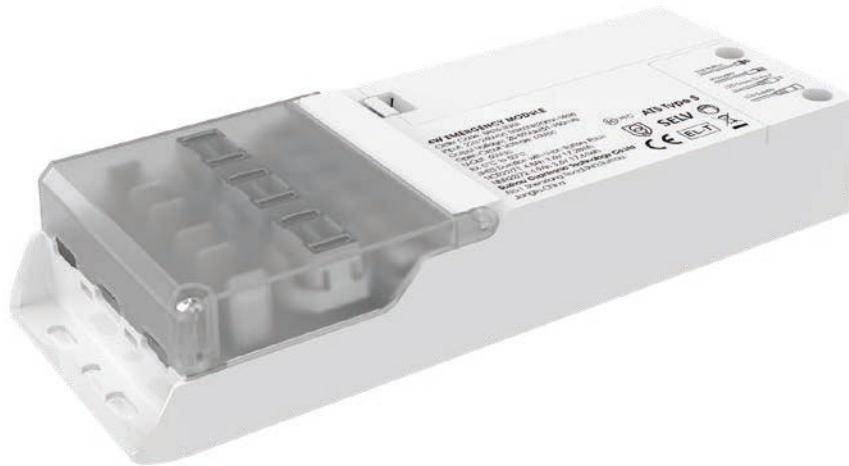

- \_ Fornito con connettori DC per veloce installazione su pannelli LED ed altri dispositivi che ne sono dotati
- \_ Corrente in uscita regolata automaticamente
- \_ Voltaggio in uscita 20-59V
- \_ Durata batteria di circa 3h
- \_ Batteria integrata Li-ION 3,6V 4900mAh

- \_ Supplied with DC connectors for quick installation on LED panels and other devices fitted with them
- \_ Automatically adjusted output current
- \_ Output voltage 20-59V
- \_ Battery life of approximately 3 hours
- \_ Built-in Li-ION 3,6V 4900mAh battery

POTENZA Watt	VARIANTE	CODICE	EAN	IMBALLO
-	EMERGENZA	EMK3-60-49-A	8031453035273	1/40

**COLLEGAMENTO PER CORRENTE DEL DRIVER <2,0A**  
 CONNECTION FOR DRIVER CURRENT <2.0A

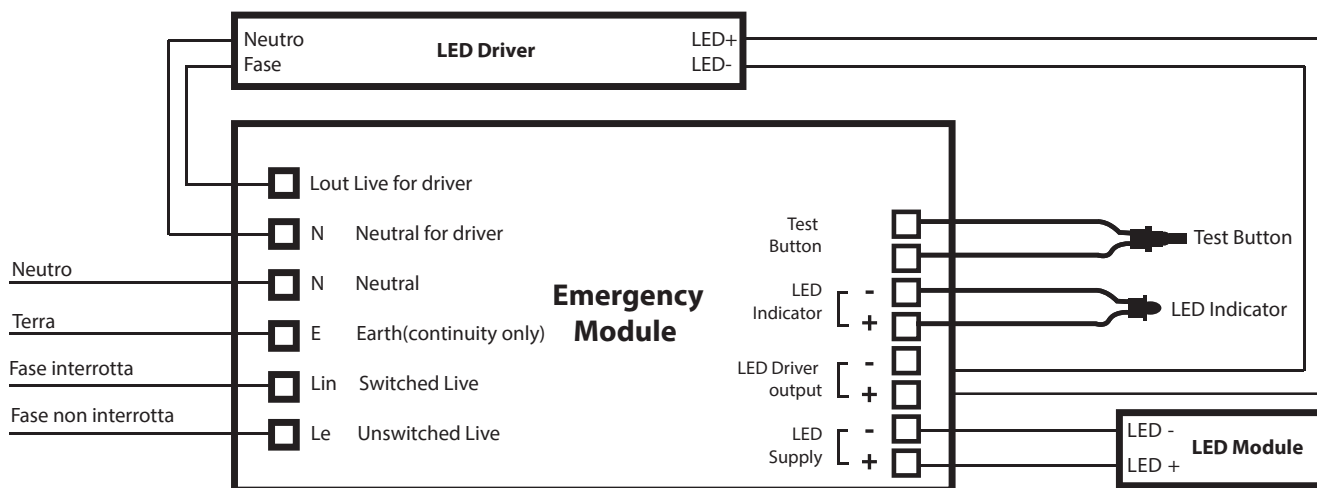

**COLLEGAMENTO PER CORRENTE DEL DRIVER >2,0A**  
 CONNECTION FOR DRIVER CURRENT > 2.0A

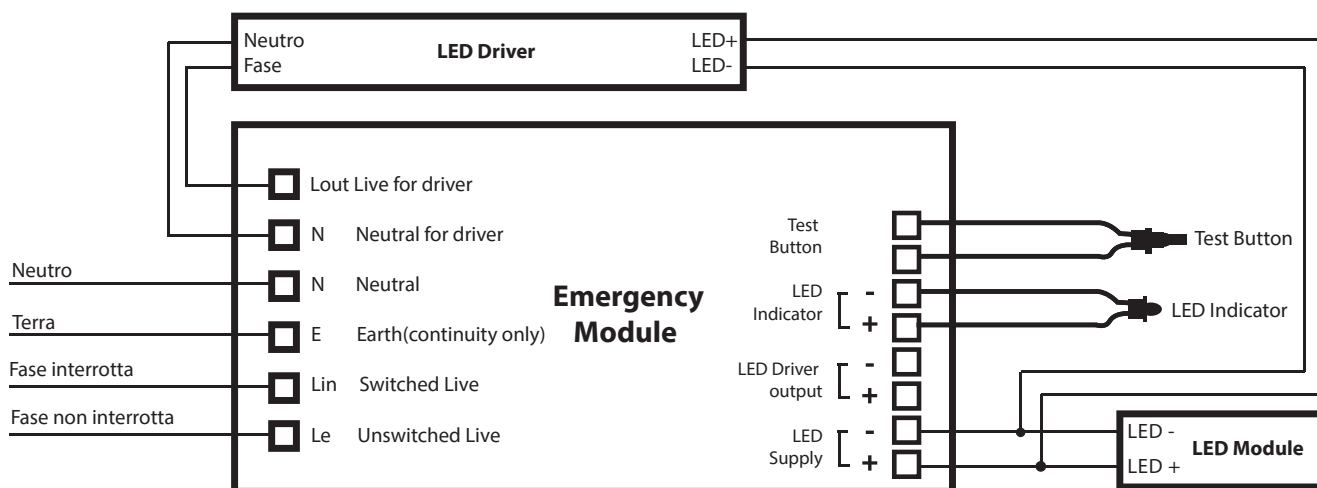





**SHOT**  
BOT LIGHTING

**TECNICO DOWNLIGHT /**  
TECHNICAL DOWNLIGHT

# DOWNLIGHT OSLO ROUND

BTL CATEGORIA SCONTO 23

Con cornice intercambiabile / With interchangeable frame

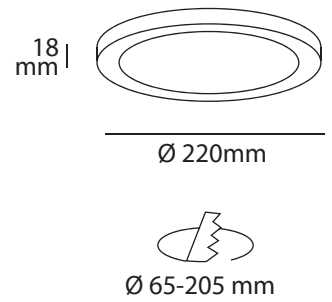

Regolabile  
Adjustable

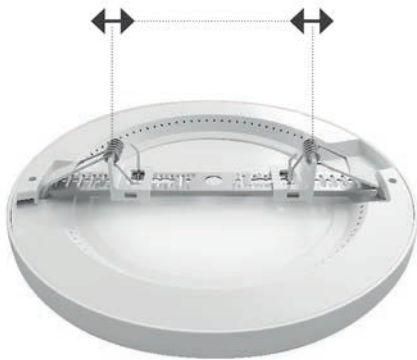

- \_ Pannello ad illuminazione laterale con driver integrato nella cornice, spessore totale 18mm
- \_ Cornice bianca in dotazione, opzionale cornice in colore argento, nero, oro rosa
- \_ Montaggio a superficie diretto, o con staffa a sgancio rapido
- \_ Montaggio ad incasso con staffa regolabile per foro Ø65-205mm
- \_ CCT selezionabile

- \_ Panel with side light source and driver incorporated in the frame, total thickness 18mm
- \_ Supplied with white frame, optional frame in silver, black, pink gold colour
- \_ Direct surface mounted or with quick release mounting bracket
- \_ Recessed with adjustable mounting bracket for Ø65-205mm hole
- \_ Selectable CCT



W	K	LUMEN APPARECCHIO lm	LUMEN SORGENTE lm		VARIANTE	CODICE	EAN		
18	<input type="checkbox"/> 3000 <input checked="" type="checkbox"/> 4000 <input type="checkbox"/> 5700	1600	2200	110°	-	OSLO185XC	8031453022334	1/20	A+ E

ACCESSORI / ACCESSORIES

	ARGENTO / SILVER	OSLO01A	8031453022273	1	-
	NERO / BLACK	OSLO01N	8031453022280	1	-
	ORO ROSA / PINKGOLD	OSLO01R	8031453022297	1	-

# DOWNLIGHT BIG OSLO ROUND

BTL CATEGORIA SCONTO 23

Con cornice intercambiabile / With interchangeable frame

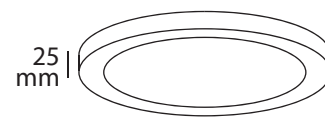

Ø 330mm



Ø 65-310 mm

Regolabile  
Adjustable

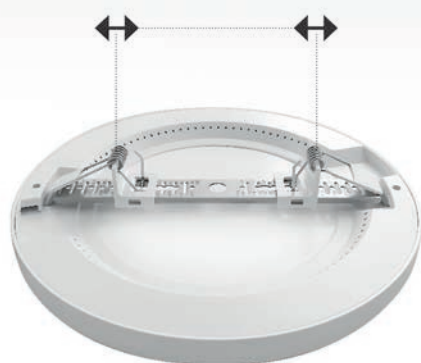

- Pannello ad illuminazione laterale con driver integrato nella cornice, spessore totale 25mm
- Cornice bianca in dotazione, opzionale cornice in colore argento, nero, oro rosa
- Montaggio a superficie diretto, o con staffa a sgancio rapido
- Montaggio ad incasso con staffa regolabile per foro Ø65-310mm
- CCT selezionabile

- Panel with side light source and driver incorporated in the frame, total thickness 25mm
- Supplied with white frame, optional frame in silver, black, pink gold colour
- Direct surface mounted or with quick release mounting bracket
- Recessed with adjustable mounting bracket for Ø65-310mm hole
- Selectable CCT



W	K	LUMEN APPARECCHIO lm	LUMEN SORGENTE lm	Beam Angle	VARIANTE	CODICE	EAN	Box	Energy Class
28	<input type="checkbox"/> 3000 <input type="checkbox"/> 4000 <input type="checkbox"/> 5700	2500	3200	110°	-	OSLO285XC	8031453025236	1/10	A+ G F

ACCESSORI / ACCESSORIES		Color	CODICE	EAN	Quantity	Energy Class
		ARGENTO / SILVER	OSLO11A	8031453025243	1	-
		NERO / BLACK	OSLO11N	8031453025250	1	-
		ORO ROSA / PINKGOLD	OSLO11R	8031453025267	1	-

# DOWNLIGHT OSLO SQUARED

BTL CATEGORIA SCONTO 23

Con cornice intercambiabile / With interchangeable frame

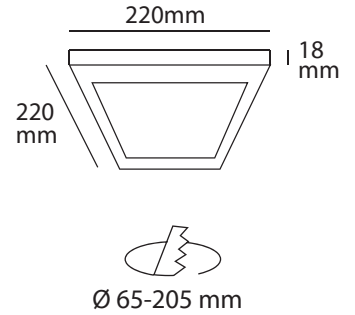

Regolabile  
Adjustable

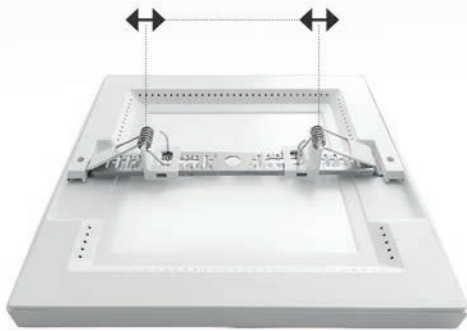

- \_ Pannello ad illuminazione laterale con driver integrato nella cornice, spessore totale 18mm
- \_ Cornice bianca in dotazione, opzionale cornice in colore argento, nero, oro rosa
- \_ Montaggio a superficie diretto, o con staffa a sgancio rapido
- \_ Montaggio ad incasso con staffa regolabile per foro Ø65-205mm
- \_ CCT selezionabile

- \_ Panel with side light source and driver incorporated in the frame, total thickness 18mm
- \_ Supplied with white frame, optional frame in silver, black, pink gold colour
- \_ Direct surface mounted or with quick release mounting bracket
- \_ Recessed with adjustable mounting bracket for Ø65-205mm hole
- \_ Selectable CCT



W	K	LUMEN APPARECCHIO lm	LUMEN SORGENTE lm		VARIANTE	CODICE	EAN		
18	<input type="checkbox"/> 3000 <input type="checkbox"/> 4000 <input type="checkbox"/> 5700	1600	2200	110°	-	<b>OSLO185XQ</b>	8031453022341	1/20	

ACCESSORI / ACCESSORIES					VARIANTE	CODICE	EAN		
					ARGENTO / SILVER	<b>OSLO02A</b>	8031453022303	1	-
					NERO / BLACK	<b>OSLO02N</b>	8031453022310	1	-
					ORO ROSA / PINKGOLD	<b>OSLO02R</b>	8031453022327	1	-



**OSLO SQUARED**

# DOWNLIGHT BODO CCT

BTL CATEGORIA SCONTO 23

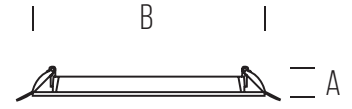

Dimensioni	A	B	Ø
1	36	90	Ø 75
2	46	115	Ø 100
3	48	165	Ø 150
4	50	190	Ø 175
5	50	215	Ø 200

- \_ Apparecchio a LED da incasso in materiale termoplastico con alimentatore integrato
- \_ Leggeri ed ideali per controsoffitti
- \_ Corpo bianco in termoplastica e metallo, con diffusore in termoplastico satinato anti abbagliamento
- \_ Completo di morsetto per un cablaggio semplificato
- \_ CCT selezionabile

- \_ Recessed LED luminaire in thermoplastic material with integrated power supply
- \_ Lightweight and ideal for false ceilings
- \_ White body in thermoplastic and metal, with satin thermoplastic diffuser anti glare
- \_ Complete with terminal for simplified wiring
- \_ Selectable CCT



W	K	LUMEN APPARECCHIO lm	MISURE	VARIANTE	CODICE	EAN			
4	3000 4200 6500	380	100° 1	-	<b>BODO4</b>	8031453025779	1/20	ATG	F
8	3000 4200 6500	780	100° 2	-	<b>BODO8</b>	8031453025786	1/20	ATG	F
16	3000 4200 6500	1700	100° 3	-	<b>BODO16</b>	8031453025793	1/20	ATG	F
20	3000 4200 6500	2150	100° 4	-	<b>BODO20</b>	8031453025809	1/20	ATG	F
24	3000 4200 6500	2650	100° 5	-	<b>BODO24</b>	8031453025816	1/20	ATG	F

# DOWNLIGHT BODO II CCT DIMMERABILE

BTL CATEGORIA SCONTO 23

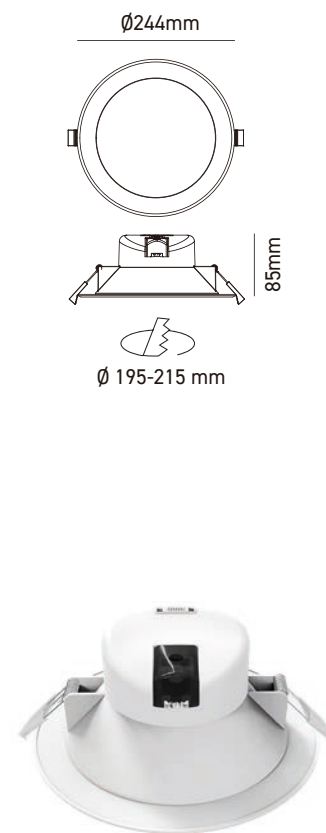

- \_ Apparecchio a LED da incasso in materiale termoplastico con alimentatore integrato
- \_ Protezione frontale IP44, posteriore IP20
- \_ Disponibile modulo emergenza che garantisce 3 ore di autonomia a 350 lumen
- \_ CCT selezionabile

- \_ Recessed LED luminaire in thermoplastic material with integrated power supply
- \_ IP44 front, IP20 rear protection
- \_ Emergency module available, providing 3 hours of autonomy at 350 lumens
- \_ Selectable CCT



W	K	LUMEN SORGENTE lm		VARIANTE	CODICE	EAN		
24	<input type="checkbox"/> 3000 <input type="checkbox"/> 4000 <input type="checkbox"/> 6500	2800	100°	-	<b>BODOII24KD</b>	8031453033958	1/8	
BODO II - KIT EMERGENZA 3h / BODO II - EMERGENCY KIT 3h					<b>BODOIIEM3</b>	8031453033965	1	

# DOWNLIGHT BODO

BTL CATEGORIA SCONTO 23

Downlight orientabile / Adjustable downlight



Dimensioni	A	B	
1	46	85	Ø 75
2	84	140	Ø 125

- \_ Apparecchio a LED da incasso in materiale termoplastico con alimentatore integrato
- \_ Leggeri ed ideali per controsoffitti
- \_ Corpo bianco in termoplastica e metallo, con diffusore in termoplastico satinato
- \_ Versione orientabile
- \_ Completo di morsetto per un cablaggio semplificato

- \_ Recessed LED luminaire in thermoplastic material with integrated power supply
- \_ Lightweight and ideal for false ceilings
- \_ White body in thermoplastic and metal, with satin thermoplastic diffuser
- \_ Adjustable version
- \_ Complete with terminal for simplified wiring



W	K	LUMEN APPARECCHIO lm		MISURE	VARIANTE	CODICE	EAN			
6		3000	425	36°	1	-	<b>BODO620</b>	8031453025823	1/20	
6		4000	425	36°	1	-	<b>BODO630</b>	8031453025830	1/20	
20		3000	1530	36°	2	-	<b>BODO2020</b>	8031453026011	1/20	
20		4000	1530	36°	2	-	<b>BODO2030</b>	8031453026028	1/20	



**BODO**

**GALA** NEW

BTL CATEGORIA SCONTO 23

Downlight CCT

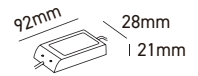
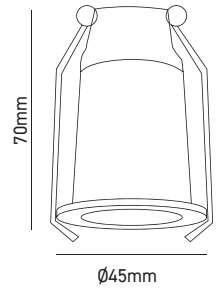

Driver separato compreso nella confezione  
Separate driver included in the package



- \_ Apparecchio a LED da incasso in alluminio verniciato bianco e riflettore verniciato nero
- \_ Basso abbagliamento UGR<16 e alta resa cromatica CRI>90
- \_ Driver Eaglerise separato
- \_ CCT selezionabile tramite selettore sul driver

- \_ Recessed LED downlight in white painted aluminium with a black painted reflector
- \_ Low glare URG<16 and high color rendering index CRI>90
- \_ Separate Eaglerise driver
- \_ CCT selectable via selectors on the external driver

IP 20
220-240V
3 ANNI GARANZIA
25.000h
CCT
UGR <16
CRI >90

W	K	LUMEN APPARECCHIO lm	LUMEN SORGENTE lm		VARIANTE	CODICE	EAN		
6	<input type="checkbox"/> 3000 <input type="checkbox"/> 4000 <input type="checkbox"/> 6500	400	600	24°	-	<b>GALA6B</b>	8031453035525	1/30	<b>A t G F</b>

**GROV** **NEW**

BTL CATEGORIA SCONTO 23

Downlight CCT

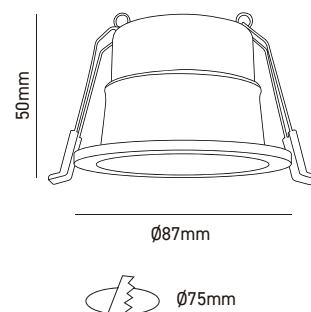

- \_ Apparecchio a LED da incasso in metallo con alimentatore integrato
- \_ Protezione frontale IP65, posteriore IP20
- \_ Basso abbagliamento UGR<19
- \_ Completo di morsetto per un cablaggio semplificato
- \_ Disponibile nei colori bianco o nero
- \_ CCT selezionabile

- \_ Recessed metal LED downlight with built-in driver
- \_ IP65 front, IP20 rear protection
- \_ Low glare URG<16
- \_ Complete with terminal block for simplified wiring
- \_ Available in white or black finish
- \_ Selectable CCT

IP 65/20
220-240V
25.000h 3 ANNI GARANZIA
CCT
UGR <19

W	K	LUMEN APPARECCHIO lm	LUMEN SORGENTE lm	◡	VARIANTE	CODICE	EAN	📦	🌱
8	<input type="checkbox"/> 3000 <input type="checkbox"/> 4000 <input type="checkbox"/> 6500	750	1000	38°	<input type="checkbox"/> BIANCO / WHITE	<b>GROV8B</b>	8031453035464	1/30	A+ G E
8	<input type="checkbox"/> 3000 <input type="checkbox"/> 4000 <input type="checkbox"/> 6500	700	1000	38°	<input checked="" type="checkbox"/> NERO / BLACK	<b>GROV8N</b>	8031453035471	1/30	A+ G E





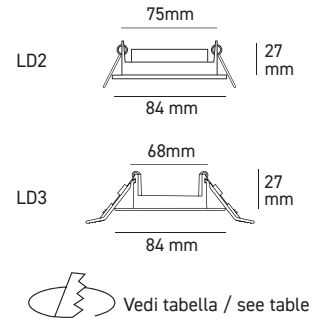
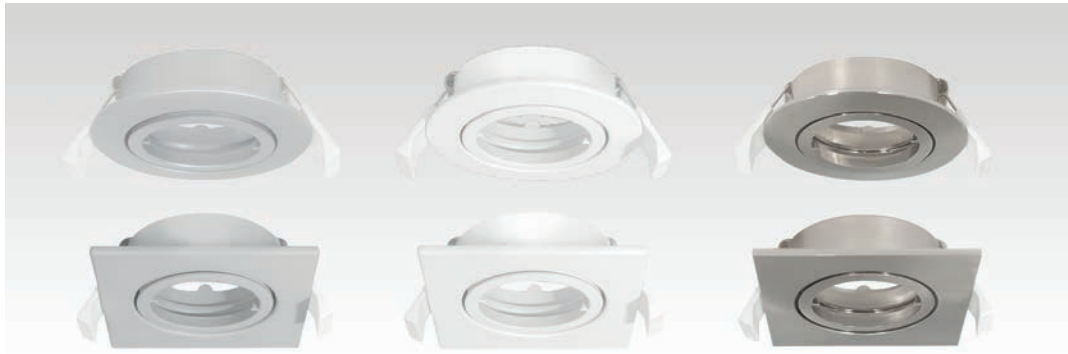



## ANELLI DI FISSAGGIO ORIENTABILI ADJUSTABLE FIXING RINGS

BTL CATEGORIA  
SCONTO 23



\_ Faretto orientabile per montaggio ad incasso, realizzato in fusione di alluminio  
\_ Alloggia lampade alogene e LED diametro 50mm con base GU10-G4 (portalampada non fornito)

\_ Recessed adjustable spotlight, made from die-cast aluminium  
\_ Houses 50mm diameter halogen and LED bulbs with GU10 - G4 base (lampholder not supplied)

VARIANTE	 $\varnothing$ mm	CODICE	EAN	
 CIRCOLARE ARGENTO / CIRCULAR SILVER	75	LD2SPTA01A	8031453020712	1/100
 CIRCOLARE BIANCO / CIRCULAR WHITE	75	LD2SPTA01B	8031453020729	1/100
 CIRCOLARE SPAZZOLATO / CIRCULAR BRUSHED	75	LD2SPTA01S	8031453020736	1/100
 QUADRATO ARGENTO / SILVER SQUARE	68 - 75	LD3SPTA02A	8031453025977	1/100
 QUADRATO BIANCO / WHITE SQUARE	75	LD2SPTA02B	8031453020750	1/100
 QUADRATO SPAZZOLATO / BRUSHED SQUARE	68 - 75	LD3SPTA02S	8031453025991	1/100

## ANELLO DI FISSAGGIO FISSO CON VETRO FRONTALE IP65 IP65 FIXING RING WITH FRONT GLASS

BTL CATEGORIA  
SCONTO 23



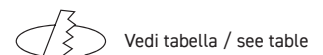
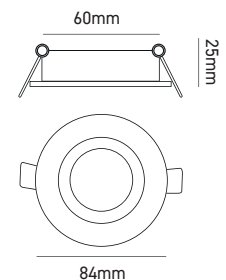

IP 65



\_ Faretto per montaggio ad incasso, realizzato in fusione di alluminio  
\_ Alloggia lampade alogene e LED diametro 50mm con base GU10-G4 (portalampada non fornito)  
\_ Vetro di protezione per garantire l'indice di protezione IP65

\_ Recessed spotlight, made from die-cast aluminium  
\_ Houses 50mm diameter halogen and LED bulbs with GU10 - G4 base (lampholder not supplied)  
\_ IP65 protection ensured by front glass

VARIANTE	 $\varnothing$ mm	CODICE	EAN	
 CIRCOLARE BIANCO IP65 / CIRCULAR WHITE IP65	60 - 76	LD3SPTA91B	8031453026004	1/100

## ANELLI DI FISSAGGIO ORIENTABILI PER GU10 ADJUSTABLE FIXING RINGS FOR GU10

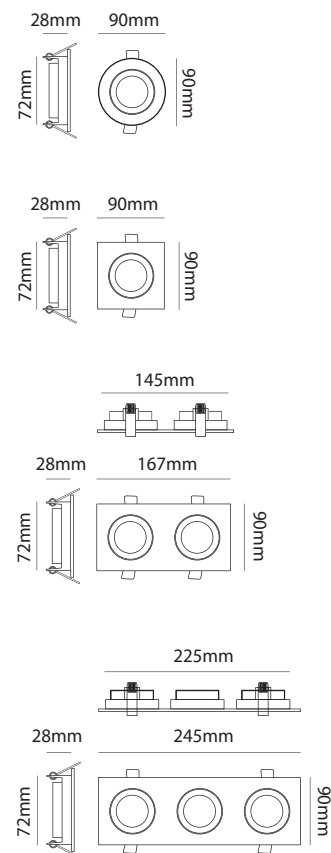

BTL CATEGORIA SCONTO 23



- \_ Faretto orientabile per montaggio ad incasso, realizzato in fusione di alluminio
- \_ Alloggia lampade alogene e LED diametro 50mm con base GU10-G4 (portalamпада non fornito)
- \_ Disponibile in versione uno, due o tre slot

- \_ Recessed adjustable spotlight, made from die-cast aluminium
- \_ Houses 50mm diameter halogen and LED bulbs with GU10 - G4 base (lampholder not supplied)
- \_ One, two or three slot available

IP 20

VARIANTE	 $\varnothing$ mm	CODICE	EAN	
<input type="checkbox"/> ROTONDO BIANCO 1 SLOT / WHITE ROUND 1 SLOT	72-80	<b>LD4SPTB01B</b>	8031453033750	1/100
<input checked="" type="checkbox"/> ROTONDO NERO 1 SLOT / BLACK ROUND 1 SLOT	72-80	<b>LD4SPTB01N</b>	8031453033767	1/100
<input type="checkbox"/> QUADRATO BIANCO 1 SLOT / WHITE SQUARE 1 SLOT	72-80	<b>LD4SPTA01B</b>	8031453031602	1/100
<input checked="" type="checkbox"/> QUADRATO NERO 1 SLOT / BLACK SQUARE 1 SLOT	72-80	<b>LD4SPTA01N</b>	8031453031619	1/100
<input type="checkbox"/> QUADRATO BIANCO 2 SLOT / WHITE SQUARE 2 SLOTS	75x150	<b>LD4SPTA02B</b>	8031453031626	1/50
<input checked="" type="checkbox"/> QUADRATO NERO 2 SLOT / BLACK SQUARE 2 SLOTS	75x150	<b>LD4SPTA02N</b>	8031453031633	1/50
<input type="checkbox"/> QUADRATO BIANCO 3 SLOT / WHITE SQUARE 3 SLOTS	75x230	<b>LD4SPTA03B</b>	8031453031640	1/50
<input checked="" type="checkbox"/> QUADRATO NERO 3 SLOT / BLACK SQUARE 3 SLOTS	75x230	<b>LD4SPTA03N</b>	8031453031657	1/50





**SHOT**  
BOT LIGHTING

**TECNICO** / TECHNICAL  
TRACK LIGHTS

# BERNA

BTL CATEGORIA SCONTO 23

Sospensione da binario / Track pendant

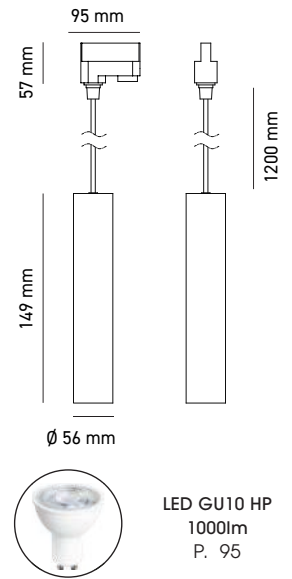

- \_ Sospensione tubolare con corpo pressofuso in alluminio
- \_ Adattatore per binario 3 fasi
- \_ Lunghezza cavo 120cm
- \_ GU10 max 7W
- \_ Verniciatura a polveri resistente ai raggi UV

- \_ Tubular pendant with die-cast aluminum body
- \_ 3-phase track adapter
- \_ Cable length 120cm
- \_ GU10 max 7W
- \_ UV-resistant powder coating



BASE		VARIANTE	CODICE	EAN	
GU10	-	<input type="checkbox"/> BIANCO / WHITE	<b>BERNAB</b>	8031453027858	1/20
GU10	-	<input checked="" type="checkbox"/> NERO / BLACK	<b>BERNAN</b>	8031453027841	1/20

## ZURIGO

BTL CATEGORIA SCONTO 23

## Lampada a sospensione / Pendant lamp

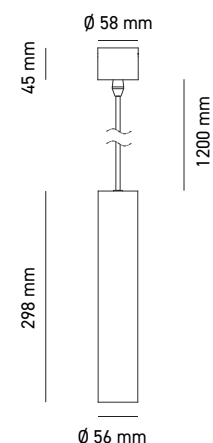

LED GU10 HP  
1000lm  
P. 95



- \_ Sospensione tubolare con corpo pressofuso in alluminio
- \_ Attacco da soffitto con rosone
- \_ Lunghezza cavo 120cm
- \_ GU10 max 7W
- \_ Verniciatura a polveri resistente ai raggi UV

- \_ Tubular pendant with die-cast aluminum body
- \_ Ceiling attachment with canopy
- \_ Cable length 120cm
- \_ GU10 max 7W
- \_ UV-resistant powder coating



BASE		VARIANTE	CODICE	EAN	
GU10	-	□ BIANCO / WHITE	ZURIGOB	8031453027872	1/20
GU10	-	■ NERO / BLACK	ZURIGON	8031453027865	1/20
GU10	-	■ CORTEN	ZURIGOC	8031453028039	1/20

# GRAZ

BTL CATEGORIA SCONTO 23

Proiettore da binario / Tracklight

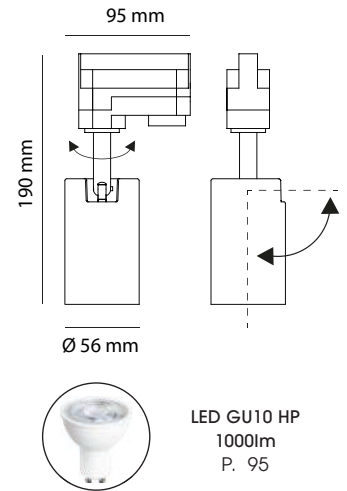

- \_ Faretto da binario con corpo pressofuso in alluminio
- \_ Adattatore per binario 3 fasi
- \_ Orientabile a 360°
- \_ GU10 max 7W
- \_ Verniciatura a polveri resistente ai raggi UV

- \_ Track spotlight with die-cast aluminum body
- \_ 3-phase track adapter
- \_ 360° adjustable
- \_ GU10 max 7W
- \_ UV-resistant powder coating



BASE		VARIANTE	CODICE	EAN	
GU10	-	<input type="checkbox"/> BIANCO / WHITE	<b>GRAZB</b>	8031453027810	1/24
GU10	-	<input checked="" type="checkbox"/> NERO / BLACK	<b>GRAZN</b>	8031453027803	1/24

## LINZ

BTL CATEGORIA SCONTO 23

## Faretto spot / Spotlight

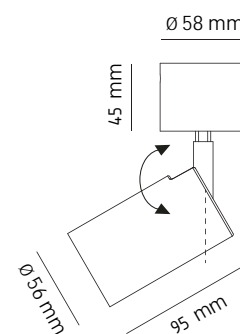

LED GU10 HP  
1000lm  
P. 95



- \_ Faretto spot con corpo pressofuso in alluminio
- \_ Attacco da soffitto con rosone
- \_ Orientabile a 360°
- \_ GU10 max 7W
- \_ Verniciatura a polveri resistente ai raggi UV

- \_ Spotlight with die-cast aluminum body
- \_ Ceiling attachment with canopy
- \_ 360° adjustable
- \_ GU10 max 7W
- \_ UV-resistant powder coating



BASE		VARIANTE	CODICE	EAN	
GU10	-	<input type="checkbox"/> BIANCO / WHITE	LINZB	8031453027834	1/24
GU10	-	<input checked="" type="checkbox"/> NERO / BLACK	LINZN	8031453027827	1/24
GU10	-	<input checked="" type="checkbox"/> CORTEN	LINZC	8031453028022	1/24

# WELS

Proiettore da binario / Tracklight

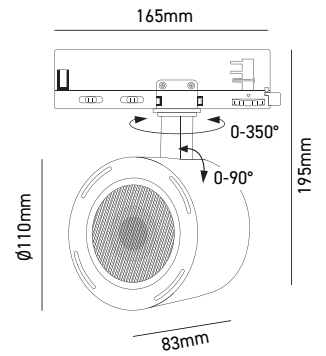

- \_ Proiettore da binario in alluminio
- \_ Possibilità di regolare il fascio da 24° a 60° in modo continuo ruotando la ghiera
- \_ Basso abbagliamento UGR<13 e alta resa cromatica CRI>92
- \_ Potenza e CCT selezionabili

- \_ Aluminium tracklight
- \_ Adjustable beam angle from 24° to 60° by rotating the ring
- \_ Low glare with UGR < 13 and high color rendering index CRI > 92
- \_ Power and CCT selectable

IP 20
175-265V
5 ANNI GARANZIA
50.000h
CCT
POWER
UGR <13
CRI >92

W	K	LUMEN APPARECCHIO lm	LUMEN SORGENTE lm	△	VARIANTE	CODICE	EAN	📦	🌱
30	2700	2000	3300		☐ BIANCO / WHITE	<b>WELS40B</b>	8031453034559	1/10	A+ G F
34	3000	2200	3500	24-60°					
40	4000	2500	4200						
30	2700	2000	3300		■ NERO / BLACK	<b>WELS40N</b>	8031453034566	1/10	A+ G F
34	3000	2200	3500	24-60°					
40	4000	2500	4200						



WELS

Proiettore da binario / Tracklight

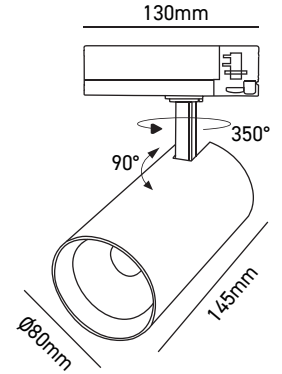

- \_ Proiettore da binario in alluminio
- \_ Driver Philips con dip-switch per selezione della potenza
- \_ Disponibile in 4 fasci 15°, 24°, 36° e 60°
- \_ Alta resa cromatica CRI>90
- \_ CCT selezionabile tramite selettore sul corpo della lampada

- \_ Aluminium tracklight
- \_ Philips driver with dip-switch for power selection
- \_ Available in 4 beam angles: 15°, 24°, 36° and 60°
- \_ High color rendering index CRI>90
- \_ CCT selectable via selector on the lamp body

IP 20
175-265V

50.000h  
5 ANNI GARANZIA
-20°+40°
 CCT
 POWER

CRI > 90

W	K	LUMEN APPARECCHIO lm	LUMEN SORGENTE lm		VARIANTE	CODICE	EAN		
36		4000	4900	15°	<input type="checkbox"/> BIANCO / WHITE	<b>PERG421B</b>	8031453035532	1/10	
38	2700	4200	5100						
40	3000	4500	5400						
42	4000	4700	5600						
36		4000	4900	24°	<input type="checkbox"/> BIANCO / WHITE	<b>PERG422B</b>	8031453035549	1/10	
38	2700	4200	5100						
40	3000	4500	5400						
42	4000	4700	5600						
36		4000	4900	36°	<input type="checkbox"/> BIANCO / WHITE	<b>PERG423B</b>	8031453035556	1/10	
38	2700	4200	5100						
40	3000	4500	5400						
42	4000	4700	5600						
36		4000	4900	60°	<input type="checkbox"/> BIANCO / WHITE	<b>PERG424B</b>	8031453035563	1/10	
38	2700	4200	5100						
40	3000	4500	5400						
42	4000	4700	5600						
36		4000	4900	15°	<input checked="" type="checkbox"/> NERO / BLACK	<b>PERG421N</b>	8031453035587	1/10	
38	2700	4200	5100						
40	3000	4500	5400						
42	4000	4700	5600						
36		4000	4900	24°	<input checked="" type="checkbox"/> NERO / BLACK	<b>PERG422N</b>	8031453035594	1/10	
38	2700	4200	5100						
40	3000	4500	5400						
42	4000	4700	5600						
36		4000	4900	36°	<input checked="" type="checkbox"/> NERO / BLACK	<b>PERG423N</b>	8031453035600	1/10	
38	2700	4200	5100						
40	3000	4500	5400						
42	4000	4700	5600						
36		4000	4900	60°	<input checked="" type="checkbox"/> NERO / BLACK	<b>PERG424N</b>	8031453035617	1/10	
38	2700	4200	5100						
40	3000	4500	5400						
42	4000	4700	5600						



Proiettore da binario dimmerabile DALI 2 / DALI 2 dimmable tracklight

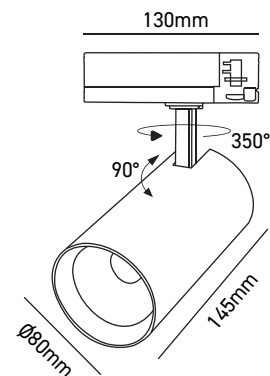

- \_ Proiettore da binario in alluminio
- \_ Driver Eaglerise dimmerabile DALI 2/PUSH
- \_ Disponibile in 4 fasci 15°, 24°, 36° e 60°
- \_ Alta resa cromatica CRI>90
- \_ CCT selezionabile tramite selettore sul corpo della lampada

- \_ Aluminium tracklight
- \_ DALI 2/PUSH dimmable Eaglerise driver
- \_ Available in 4 beam angles: 15°, 24°, 36° and 60°
- \_ High color rendering index CRI>90
- \_ CCT selectable via selector on the lamp body

IP 20
175-265V

50.000h  
5 ANNI GARANZIA
-20°+40°
  
CCT

CRI > 90

W	K	LUMEN APPARECCHIO lm	LUMEN SORGENTE lm		VARIANTE	CODICE	EAN		
42	<span style="background-color: #e67e22; width: 10px; height: 10px; display: inline-block;"></span> 2700	4700	5600	15°	<input type="checkbox"/> BIANCO / WHITE	<b>PERG421BDALI</b>	8031453035822	1/10	
	<span style="background-color: #f1c40f; width: 10px; height: 10px; display: inline-block;"></span> 3000								
	<input type="checkbox"/> 4000								
42	<span style="background-color: #e67e22; width: 10px; height: 10px; display: inline-block;"></span> 2700	4700	5600	24°	<input type="checkbox"/> BIANCO / WHITE	<b>PERG422BDALI</b>	8031453035846	1/10	
	<span style="background-color: #f1c40f; width: 10px; height: 10px; display: inline-block;"></span> 3000								
	<input type="checkbox"/> 4000								
42	<span style="background-color: #e67e22; width: 10px; height: 10px; display: inline-block;"></span> 2700	4700	5600	36°	<input type="checkbox"/> BIANCO / WHITE	<b>PERG423BDALI</b>	8031453035860	1/10	
	<span style="background-color: #f1c40f; width: 10px; height: 10px; display: inline-block;"></span> 3000								
	<input type="checkbox"/> 4000								
42	<span style="background-color: #e67e22; width: 10px; height: 10px; display: inline-block;"></span> 2700	4700	5600	60°	<input type="checkbox"/> BIANCO / WHITE	<b>PERG424BDALI</b>	8031453035884	1/10	
	<span style="background-color: #f1c40f; width: 10px; height: 10px; display: inline-block;"></span> 3000								
	<input type="checkbox"/> 4000								
42	<span style="background-color: #e67e22; width: 10px; height: 10px; display: inline-block;"></span> 2700	4700	5600	15°	<input checked="" type="checkbox"/> NERO / BLACK	<b>PERG421NDALI</b>	8031453035839	1/10	
	<span style="background-color: #f1c40f; width: 10px; height: 10px; display: inline-block;"></span> 3000								
	<input type="checkbox"/> 4000								
42	<span style="background-color: #e67e22; width: 10px; height: 10px; display: inline-block;"></span> 2700	4700	5600	24°	<input checked="" type="checkbox"/> NERO / BLACK	<b>PERG422NDALI</b>	8031453035853	1/10	
	<span style="background-color: #f1c40f; width: 10px; height: 10px; display: inline-block;"></span> 3000								
	<input type="checkbox"/> 4000								
42	<span style="background-color: #e67e22; width: 10px; height: 10px; display: inline-block;"></span> 2700	4700	5600	36°	<input checked="" type="checkbox"/> NERO / BLACK	<b>PERG423NDALI</b>	8031453035877	1/10	
	<span style="background-color: #f1c40f; width: 10px; height: 10px; display: inline-block;"></span> 3000								
	<input type="checkbox"/> 4000								
42	<span style="background-color: #e67e22; width: 10px; height: 10px; display: inline-block;"></span> 2700	4700	5600	60°	<input checked="" type="checkbox"/> NERO / BLACK	<b>PERG424NDALI</b>	8031453035891	1/10	
	<span style="background-color: #f1c40f; width: 10px; height: 10px; display: inline-block;"></span> 3000								
	<input type="checkbox"/> 4000								

# PERG FOOD NEW

BTL CATEGORIA SCONTO 23

## Proiettore da binario food / Food tracklight

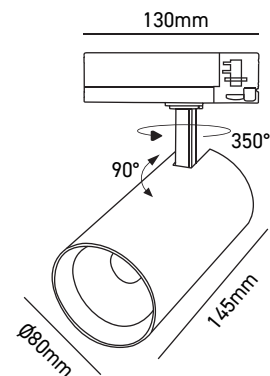
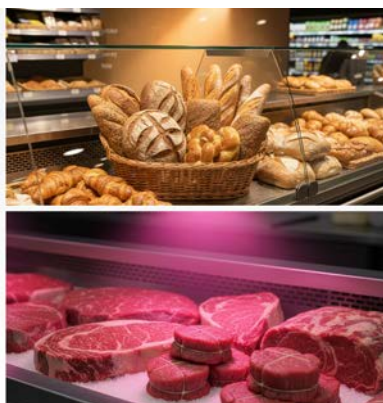

- \_ Proiettore da binario in alluminio
- \_ Tonalità di luce selezionabile tramite selettore sul corpo della lampada tra colore dedicato per carni e per prodotti da forno mediante selettore
- \_ Driver Philips con dip-switch per selezione della potenza
- \_ Disponibile in 4 fasci 15°, 24°, 36° e 60°
- \_ \* I valori di flusso luminoso (lumen) tra sorgenti a luce bianca (es. 4000K) e sorgenti a luce speciale (es. spettro "Food") non sono direttamente comparabili. Per ulteriori informazioni consultare la scheda tecnica.

- \_ Aluminium tracklight
- \_ Selectable light colour via selector on the lamp body: dedicated setting for meat or bakery products
- \_ Philips driver with dip-switch for power selection
- \_ Available with 4 beam angle options: 15°, 24°, 36° and 60°
- \_ \* Luminous flux values (lumens) for white-light sources (e.g. 4000K) and special-light sources (e.g. "Food" spectrum) are not directly comparable. For further information, please refer to the technical data sheet.

IP 20

175-265V

50.000h  
5 ANNI GARANZIA

-20°+40°

POWER



W	K	LUMEN SORGENTE lm	△	VARIANTE	CODICE	EAN	📦
36		2100*	15°	☐ BIANCO / WHITE	PERG421BFOOD	8031453035631	1/10
38	☐ BREAD	2200*					
40	☑ MEAT	2300*					
42		2400*					
36		2100*	24°	☐ BIANCO / WHITE	PERG422BFOOD	8031453035655	1/10
38	☐ BREAD	2200*					
40	☑ MEAT	2300*					
42		2400*					
36		2100*	36°	☐ BIANCO / WHITE	PERG423BFOOD	8031453035679	1/10
38	☐ BREAD	2200*					
40	☑ MEAT	2300*					
42		2400*					
36		2100*	60°	☐ BIANCO / WHITE	PERG424BFOOD	8031453035693	1/10
38	☐ BREAD	2200*					
40	☑ MEAT	2300*					
42		2400*					
36		2100*	15°	☑ NERO / BLACK	PERG421NFOOD	8031453035648	1/10
38	☐ BREAD	2200*					
40	☑ MEAT	2300*					
42		2400*					
36		2100*	24°	☑ NERO / BLACK	PERG422NFOOD	8031453035662	1/10
38	☐ BREAD	2200*					
40	☑ MEAT	2300*					
42		2400*					
36		2100*	36°	☑ NERO / BLACK	PERG423NFOOD	8031453035686	1/10
38	☐ BREAD	2200*					
40	☑ MEAT	2300*					
42		2400*					
36		2100*	60°	☑ NERO / BLACK	PERG424NFOOD	8031453035709	1/10
38	☐ BREAD	2200*					
40	☑ MEAT	2300*					
42		2400*					



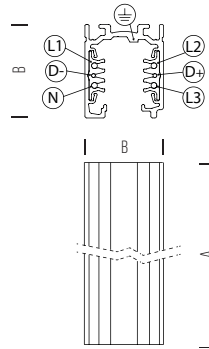
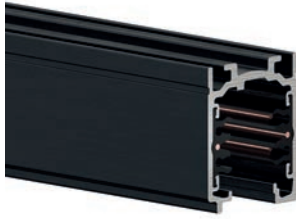



## BINARIO A 6 CONDUTTORI EUROSTANDARD PLUS EUROSTANDARD PLUS 6 CONDUCTORS TRACK



Dimensioni	A	B	C
1	37,8	31,4	1000
2	37,8	31,4	2000
3	37,8	31,4	3000

IP 20



DESCRIZIONE	VARIANTE	MATERIALE	MISURE mm	CODICE	
BINARIO A 6 CONDUTTORI EUROSTANDARD PLUS METRI 1	 NERO / BLACK	ALLUMINIO / ALUMINUM	1	9000-1/B-ST	1
BINARIO A 6 CONDUTTORI EUROSTANDARD PLUS METRI 1	 BIANCO / WHITE	ALLUMINIO / ALUMINUM	1	9000-1/W-ST	1
BINARIO A 6 CONDUTTORI EUROSTANDARD PLUS METRI 2	 NERO / BLACK	ALLUMINIO / ALUMINUM	2	9000-2/B-ST	1
BINARIO A 6 CONDUTTORI EUROSTANDARD PLUS METRI 2	 BIANCO / WHITE	ALLUMINIO / ALUMINUM	2	9000-2/W-ST	1
BINARIO A 6 CONDUTTORI EUROSTANDARD PLUS METRI 3	 NERO / BLACK	ALLUMINIO / ALUMINUM	3	9000-3/B-ST	1
BINARIO A 6 CONDUTTORI EUROSTANDARD PLUS METRI 3	 BIANCO / WHITE	ALLUMINIO / ALUMINUM	3	9000-3/W-ST	1

## TAPPO DI CHIUSURA PER BINARIO CON VITE DI BLOCCO END CAP FOR TRACK WITH LOCKING SCREW

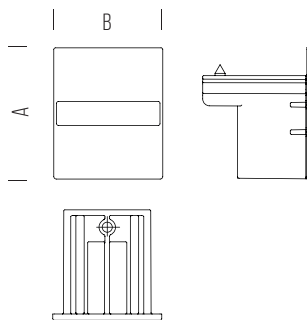

Dimensioni	A	B
1	37,8	31,4

IP 20



DESCRIZIONE	VARIANTE	MATERIALE	MISURE mm	CODICE	
TAPPO DI CHIUSURA PER BINARIO CON VITE DI BLOCCO	 NERO / BLACK	POLICARBONATO / POLYCARBONATE	1	9004/B	1
TAPPO DI CHIUSURA PER BINARIO CON VITE DI BLOCCO	 BIANCO / WHITE	POLICARBONATO / POLYCARBONATE	1	9004/W	1

**GIUNTO A L POLARITA' ESTERNA**

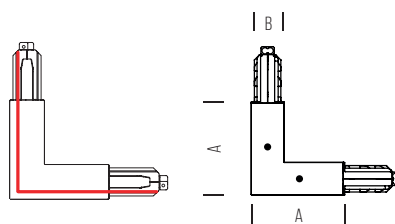

L-FEED - EXTERNAL POLARITY



Dimensioni	A	B
1	89,7	25,4

IP 20



DESCRIZIONE	VARIANTE	MATERIALE	MISURE mm	CODICE	
GIUNTO A L POLARITÀ ESTERNA	 NERO / BLACK	POLICARBONATO / POLYCARBONATE	1	9012/B	1
GIUNTO A L POLARITÀ ESTERNA	 BIANCO / WHITE	POLICARBONATO / POLYCARBONATE	1	9012/W	1

**GIUNTO A L POLARITA' INTERNA**

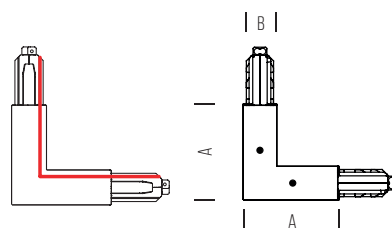

L-FEED - INTERNAL POLARITY



Dimensioni	A	B
1	89,7	25,4

IP 20



DESCRIZIONE	VARIANTE	MATERIALE	MISURE mm	CODICE	
GIUNTO A L POLARITÀ INTERNA	 NERO / BLACK	POLICARBONATO / POLYCARBONATE	1	9011/B	1
GIUNTO A L POLARITÀ INTERNA	 BIANCO / WHITE	POLICARBONATO / POLYCARBONATE	1	9011/W	1

**TESTATA DI ALIMENTAZIONE POLARITA' DESTRA**

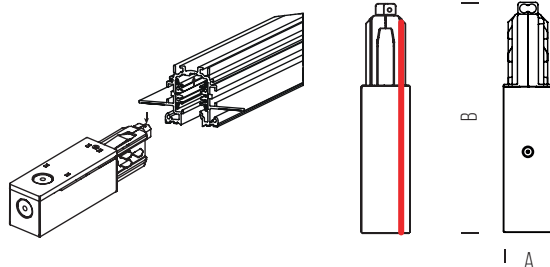

END-FEED - RIGHT



Dimensioni	A	B
1	95	31,4

IP 20



DESCRIZIONE	VARIANTE	MATERIALE	MISURE mm	CODICE	
TESTATA DI ALIMENTAZIONE POLARITÀ DESTRA	 NERO / BLACK	POLICARBONATO / POLYCARBONATE	1	9001/B	1
TESTATA DI ALIMENTAZIONE POLARITÀ DESTRA	 BIANCO / WHITE	POLICARBONATO / POLYCARBONATE	1	9001/W	1

## TESTATA DI ALIMENTAZIONE POLARITA' SINISTRA END-FEED - LEFT

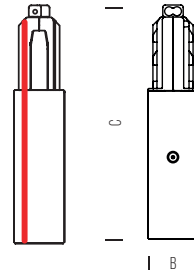
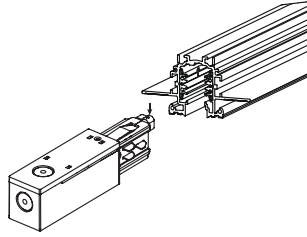
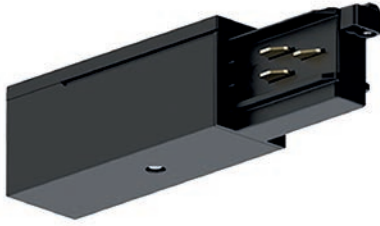

Dimensioni	A	B
1	95	31,4

IP 20



DESCRIZIONE	VARIANTE	MATERIALE	MISURE mm	CODICE	
TESTATA DI ALIMENTAZIONE POLARITÀ SINISTRA	■ NERO / BLACK	POLICARBONATO / POLYCARBONATE	1	9002/B	1
TESTATA DI ALIMENTAZIONE POLARITÀ SINISTRA	□ BIANCO / WHITE	POLICARBONATO / POLYCARBONATE	1	9002/W	1

## GIUNTO PASSANTE PER BINARIO JOINTING CONNECTOR

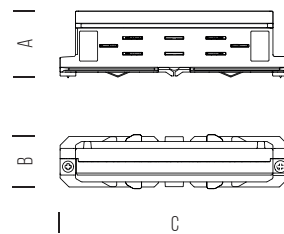
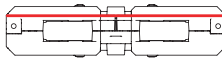

Dimensioni	A	B	C
1	32,6	25,4	114,7
2	37,8	31,4	114,7

IP 20



DESCRIZIONE	VARIANTE	MATERIALE	MISURE mm	CODICE	
GIUNTO PASSANTE PER BINARIO	■ NERO / BLACK	POLICARBONATO / POLYCARBONATE	1	9003/B	1
GIUNTO PASSANTE PER BINARIO	□ BIANCO / WHITE	POLICARBONATO / POLYCARBONATE	2	9003/W	1

**GIUNTO DIRETTO CON ALIMENTAZIONE DAL CENTRO**

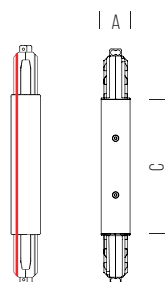

MIDDLE FEED FOR 2 CIRCUITS APPLICATION



Dimensioni	A	B	C
1	37,8	25,4	148

IP 20



DESCRIZIONE	VARIANTE	MATERIALE	MISURE mm	CODICE	
GIUNTO DIRETTO CON ALIMENTAZIONE DAL CENTRO	 NERO / BLACK	POLICARBONATO / POLYCARBONATE	1	9010/B	1
GIUNTO DIRETTO CON ALIMENTAZIONE DAL CENTRO	 BIANCO / WHITE	POLICARBONATO / POLYCARBONATE	1	9010/W	1

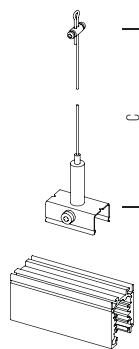

**KIT COMPLETO PER FISSAGGIO A SOSPENSIONE BINARIO**

COMPLETE SUSPENSION KIT FOR TRACK



Dimensioni	C
1	1500
2	3000
3	5000

IP 20

DESCRIZIONE	VARIANTE	MATERIALE	MISURE mm	CODICE	
KIT COMPLETO PER FISSAGGIO A SOSPENSIONE BINARIO - 1,5 M	 ACCIAIO / STEEL	ACCIAIO / STEEL	1	9000-KIT1-1.5	1
KIT COMPLETO PER FISSAGGIO A SOSPENSIONE BINARIO - 3 M	 ACCIAIO / STEEL	ACCIAIO / STEEL	2	9000-KIT1-3	1
KIT COMPLETO PER FISSAGGIO A SOSPENSIONE BINARIO - 5 M	 ACCIAIO / STEEL	ACCIAIO / STEEL	3	9000-KIT1-5	1





**SHOT**  
BOT LIGHTING

**TECNICO / STRISCE LED**  
TECHNICAL / LED STRIP

# HD LED STRIP IP20 24V

AGGIORNATO

BTL CATEGORIA SCONTO 23

Striscia LED / LED Strip



- \_ Striscia LED adesiva ad alta potenza
- \_ Alta densità di LED per metro
- \_ Lunghezza rotolo 5 metri (tagliabile in corrispondenza dei punti marcati sulla striscia)
- \_ Accessori di connessione su richiesta

- \_ High power adhesive LED strip
- \_ Very high density of LEDs per meter
- \_ Roll length 5 meters (can be cut at the points marked on the strip)
- \_ Connection accessories on request

IP 20
24V DC
III
25.000h  
3 ANNI GARANZIA
-20°+40°
⚠
CRI > 90

	W/m	K	LUMEN lm/m		DIMENSIONE L x W x H mm	NUMERO LED/m	CUT SIZE mm	CODICE	EAN		
NEW	12	2700	1500	120°	5000 x 8 x 1,8	210	33	STR241592720-210	8031453035730	1/10	A ↑ G E
NEW	12	3000	1500	120°	5000 x 8 x 1,8	210	33	STR241593020-210	8031453035747	1/10	A ↑ G E
NEW	12	4000	1550	120°	5000 x 8 x 1,8	210	33	STR241594020-210	8031453035754	1/10	A ↑ G E
NEW	12	6500	1550	120°	5000 x 8 x 1,8	210	33	STR241596520-210	8031453035761	1/10	A ↑ G E
	20	3000	1900	120°	5000 x 10 x 1,4	240	25	STR242093020-240	8031453028251	1/10	A ↑ G F
	20	4000	2000	120°	5000 x 10 x 1,4	240	25	STR242094020-240	8031453028268	1/10	A ↑ G F

# COLOR STRIP IP20 24V

BTL CATEGORIA SCONTO 23

Striscia LED / LED Strip

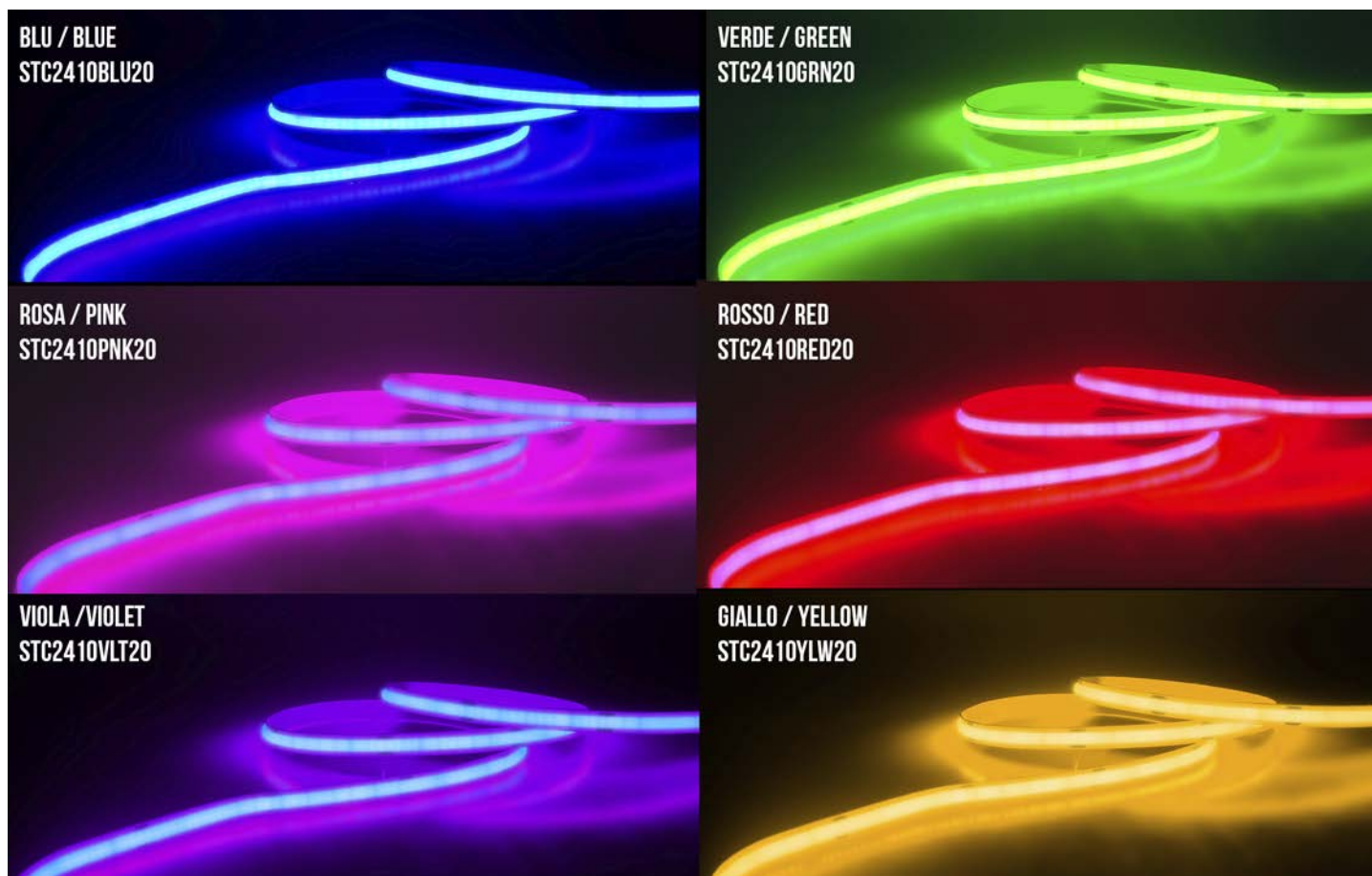

- \_ Striscia LED colorata
- \_ Lunghezza rotolo 5 metri (tagliabile in corrispondenza dei punti)
- \_ Ottimo effetto decorativo con colori brillanti e uniformi grazie alla tecnologia dot free COB
- \_ Accessori di connessione su richiesta
- \_ \* I valori di flusso luminoso (lumen) tra sorgenti a luce bianca (es. 4000K) e sorgenti a luce speciale (es. spettro "Food") non sono direttamente comparabili. Per ulteriori informazioni consultare la scheda tecnica.

- \_ Colored LED strip
- \_ Roll length 5 meters (can be cut at the points marked on the strip)
- \_ Excellent decorative effect with bright and uniform colors thanks to the dot free COB technology
- \_ Connection accessories on request
- \_ \* Luminous flux values (lumens) for white-light sources (e.g. 4000K) and special-light sources (e.g. "Food" spectrum) are not directly comparable. For further information, please refer to the technical data sheet.



W/m	LUMEN lm/m		DIMENSIONE L x W x H mm	CUT SIZE mm	VARIANTE	CODICE	EAN	
10	100*	180°	5000 x 8 x 1,8	50	BLU / BLUE	<b>STC2410BLU20</b>	8031453028275	1/2
10	750*	180°	5000 x 8 x 1,8	50	VERDE / GREEN	<b>STC2410GRN20</b>	8031453028282	1/2
10	500*	180°	5000 x 8 x 1,8	50	ROSA / PINK	<b>STC2410PNK20</b>	8031453028299	1/2
10	200*	180°	5000 x 8 x 1,8	50	ROSSO / RED	<b>STC2410RED20</b>	8031453028305	1/2
10	300*	180°	5000 x 8 x 1,8	50	VIOLA / VIOLET	<b>STC2410VLT20</b>	8031453028312	1/2
10	500*	180°	5000 x 8 x 1,8	50	GIALLO / YELLOW	<b>STC2410YLW20</b>	8031453028329	1/2

# SMD LED STRIP IP20 24V

Striscia LED / LED Strip



- \_ Striscia LED adesiva ad alta potenza
- \_ Lunghezza rotolo 5 metri (tagliabile in corrispondenza dei punti marcati sulla striscia)
- \_ Accessori di connessione su richiesta
- \_ High power adhesive LED strip
- \_ Roll length 5 meters (can be cut at the points marked on the strip)
- \_ Connection accessories on request



W/m	K	LUMEN lm/m		DIMENSIONE L x W x H mm	NUMERO LED/m	CUT SIZE mm	CODICE	EAN			
5,1	2200	450	120°	5000 x 8 x 1,4	60	100	<b>STR240592220</b>	8031453026578	1/10		<b>G</b>
5,1	2700	480	120°	5000 x 8 x 1,4	60	100	<b>STR240592720</b>	8031453026585	1/10		<b>F</b>
5,1	3000	480	120°	5000 x 8 x 1,4	60	100	<b>STR240593020</b>	8031453026592	1/10		<b>F</b>
5,1	4000	510	120°	5000 x 8 x 1,4	60	100	<b>STR240594020</b>	8031453026608	1/10		<b>F</b>
5,1	6500	510	120°	5000 x 8 x 1,4	60	100	<b>STR240596520</b>	8031453026615	1/10		<b>F</b>
10,5	2200	860	120°	5000 x 8 x 1,4	120	50	<b>STR241092220</b>	8031453026660	1/10		<b>G</b>
10,5	2700	930	120°	5000 x 8 x 1,4	120	50	<b>STR241092720</b>	8031453026677	1/10		<b>G</b>
10,5	3000	930	120°	5000 x 8 x 1,4	120	50	<b>STR241093020</b>	8031453026684	1/10		<b>G</b>
10,5	4000	1000	120°	5000 x 8 x 1,4	120	50	<b>STR241094020</b>	8031453026691	1/10		<b>F</b>
10,5	6500	1000	120°	5000 x 8 x 1,4	120	50	<b>STR241096520</b>	8031453026707	1/10		<b>F</b>
15,5	2700	1300	120°	5000 x 8 x 1,4	120	50	<b>STR241592720</b>	8031453026752	1/10		<b>G</b>
15,5	3000	1300	120°	5000 x 8 x 1,4	120	50	<b>STR241593020</b>	8031453026769	1/10		<b>G</b>
15,5	4000	1500	120°	5000 x 8 x 1,4	120	50	<b>STR241594020</b>	8031453026776	1/10		<b>F</b>
15,5	6500	1500	120°	5000 x 8 x 1,4	120	50	<b>STR241596520</b>	8031453026783	1/10		<b>F</b>
17	2700	1850	120°	5000 x 8 x 1,4	120	50	<b>STR242092720</b>	8031453026837	1/10		<b>F</b>
17	3000	1850	120°	5000 x 8 x 1,4	120	50	<b>STR242093020</b>	8031453026844	1/10		<b>F</b>
17	4000	2000	120°	5000 x 8 x 1,4	120	50	<b>STR242094020</b>	8031453026851	1/10		<b>F</b>
17	6500	2000	120°	5000 x 8 x 1,4	120	50	<b>STR242096520</b>	8031453026868	1/10		<b>F</b>

# HD LED STRIP IP54 24V

Striscia LED / LED Strip

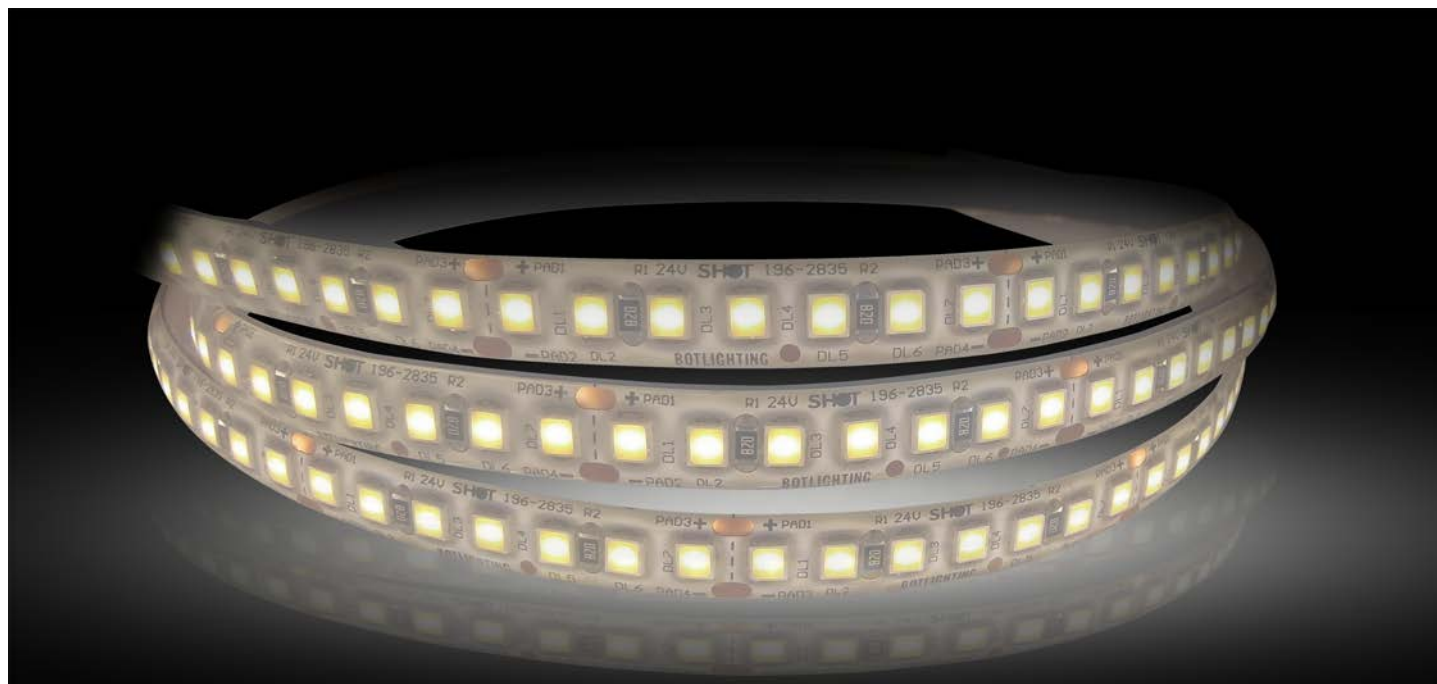

- \_ Striscia LED adesiva ad alta potenza
  - \_ Alta densità di LED per metro
  - \_ Lunghezza rotolo 5 metri (tagliabile in corrispondenza dei punti marcati sulla striscia)
  - \_ Grado di protezione IP54 (non adatta per usi esterni)
  - \_ Accessori di connessione su richiesta
- \_ High power adhesive LED strip
  - \_ Very high density of LEDs per meter
  - \_ Roll length 5 meters (can be cut at the points marked on the strip)
  - \_ Degree of protection IP54 (not suitable for outdoor use)
  - \_ Connection accessories on request

IP 54

24V DC

III

25.000h  
3 ANNI GARANZIA

-20°+40°

CRI > 90

W/m	K	LUMEN lm/m		DIMENSIONE L x W x H mm	NUMERO LED/m	CUT SIZE mm	CODICE	EAN			
14,5	2700	1350	120°	5000 x 8 x 2	196	36	<b>STR241592754</b>	8031453031336	1/10		
14,5	3000	1350	120°	5000 x 8 x 2	196	36	<b>STR241593054</b>	8031453031343	1/10		
14,5	4000	1450	120°	5000 x 8 x 2	196	36	<b>STR241594054</b>	8031453031350	1/10		
14,5	6500	1500	120°	5000 x 8 x 2	196	36	<b>STR241596554</b>	8031453031367	1/10		
17,5	2700	1700	120°	5000 x 8 x 2	196	36	<b>STR242092754</b>	8031453031374	1/10		
17,5	3000	1700	120°	5000 x 8 x 2	196	36	<b>STR242093054</b>	8031453031381	1/10		
17,5	4000	1850	120°	5000 x 8 x 2	196	36	<b>STR242094054</b>	8031453031398	1/10		
17,5	6500	2000	120°	5000 x 8 x 2	196	36	<b>STR242096554</b>	8031453031404	1/10		

# SMD LED STRIP IP54 24V

Striscia LED / LED Strip



- Striscia LED adesiva ad alta potenza
- Lunghezza rotolo 5 metri (tagliabile in corrispondenza dei punti marcati sulla striscia)
- Grado di protezione IP54 (non adatta per usi esterni)
- Accessori di connessione su richiesta
- High power adhesive LED strip
- Roll length 5 meters (can be cut at the points marked on the strip)
- Degree of protection IP54 (not suitable for outdoor use)
- Connection accessories on request

IP 54

24V DC

III

25.000h  
3 ANNI GARANZIA

-20°+40°

△

CRI  
> 90

W/m	K	LUMEN lm/m	△	DIMENSIONE L x W x H mm	NUMERO LED/m	CUT SIZE mm	CODICE	EAN	📦	🌱
5,1	2700	450	120°	5000 x 8 x 2,5	60	100	<b>STR240592754</b>	8031453026622	1/10	A ↑ G <b>G</b>
5,1	3000	450	120°	5000 x 8 x 2,5	60	100	<b>STR240593054</b>	8031453026639	1/10	A ↑ G <b>G</b>
5,1	4000	480	120°	5000 x 8 x 2,5	60	100	<b>STR240594054</b>	8031453026646	1/10	A ↑ G <b>F</b>
5,1	6500	510	120°	5000 x 8 x 2,5	60	100	<b>STR240596554</b>	8031453026653	1/10	A ↑ G <b>F</b>
10,5	2700	860	120°	5000 x 8 x 2,5	120	50	<b>STR241092754</b>	8031453026714	1/10	A ↑ G <b>G</b>
10,5	3000	860	120°	5000 x 8 x 2,5	120	50	<b>STR241093054</b>	8031453026721	1/10	A ↑ G <b>G</b>
10,5	4000	930	120°	5000 x 8 x 2,5	120	50	<b>STR241094054</b>	8031453026738	1/10	A ↑ G <b>G</b>
10,5	6500	1000	120°	5000 x 8 x 2,5	120	50	<b>STR241096554</b>	8031453026745	1/10	A ↑ G <b>F</b>

## SMD LED STRIP IP67 24V

BTL CATEGORIA SCONTO 23

Striscia LED / LED Strip



- \_ Striscia LED adesiva ad alta potenza
  - \_ Lunghezza rotolo 5 metri (tagliabile in corrispondenza dei punti marcati sulla striscia)
  - \_ Il rivestimento in silicone garantisce l'indice di protezione IP67 e la resistenza ai raggi UV
  - \_ Accessori di connessione su richiesta
- \_ High power adhesive LED strip
  - \_ Roll length 5 meters (can be cut at the points marked on the strip)
  - \_ The silicone coating guarantees the IP67 protection index and resistance to UV rays
  - \_ Connection accessories on request



W/m	K	LUMEN lm/m		DIMENSIONE L x W x H mm	NUMERO LED/m	CUT SIZE mm	CODICE	EAN		
15,5	2700	1250	120°	5000 x 10,5 x 5	120	50	<b>STR241592767</b>	8031453026790	1/10	
15,5	3000	1250	120°	5000 x 10,5 x 5	120	50	<b>STR241593067</b>	8031453026806	1/10	
15,5	4000	1450	120°	5000 x 10,5 x 5	120	50	<b>STR241594067</b>	8031453026813	1/10	
15,5	6500	1450	120°	5000 x 10,5 x 5	120	50	<b>STR241596567</b>	8031453026820	1/10	
17	2700	1800	120°	5000 x 10,5 x 5	120	50	<b>STR242092767</b>	8031453026875	1/10	
17	3000	1800	120°	5000 x 10,5 x 5	120	50	<b>STR242093067</b>	8031453026882	1/10	
17	4000	1950	120°	5000 x 10,5 x 5	120	50	<b>STR242094067</b>	8031453026899	1/10	
17	6500	1950	120°	5000 x 10,5 x 5	120	50	<b>STR242096567</b>	8031453026905	1/10	

# CSP LED STRIP IP20 24V

Striscia LED / LED Strip



- \_ Striscia LED adesiva ad alta potenza
- \_ Lunghezza rotolo 5 metri (tagliabile in corrispondenza dei punti marcati sulla striscia)
- \_ Luce confortevole ed uniforme grazie alla tecnologia 3D SMD LED
- \_ Temperatura di colore regolabile tramite controller (venduto separatamente)
- \_ Accessori di connessione su richiesta

- \_ High power adhesive LED strip
- \_ Roll length 5 meters (can be cut at the points marked on the strip)
- \_ Comfortable and uniform light thanks to 3D SMD LED technology
- \_ Color temperature adjustable via controller (sold separately)
- \_ Connection accessories on request



W/m	K	LUMEN lm/m		DIMENSIONE L x W x H mm	NUMERO LED/m	CUT SIZE mm	CODICE	EAN		
12	2100 6500	1150	180°	5000 x 10 x 1,8	-	71	<b>STC2412CCT20</b>	4060574775076	1/2	
Controller per LED Strip - Dip Switch							<b>STCCON1</b>	4060574370011	1/2	-
Controller per LED Strip - Tuya Wi-Fi							<b>STCCON2</b>	4060574370172	1/2	-

## COB LED STRIP IP20 24V

BTL CATEGORIA SCONTO 23

Striscia LED / LED Strip



- \_ Striscia LED adesiva ad alta potenza
- \_ Lunghezza rotolo 5 metri (tagliabile in corrispondenza dei punti marcati sulla striscia)
- \_ Luce confortevole ed uniforme dot free grazie alla tecnologia COB
- \_ Accessori di connessione su richiesta

- \_ High power adhesive LED strip
- \_ Roll length 5 meters (can be cut at the points marked on the strip)
- \_ Comfortable and uniform dot free light thanks to COB technology
- \_ Connection accessories on request



W/m	K	LUMEN lm/m		DIMENSIONE L x W x H mm	NUMERO LED/m	CUT SIZE mm	CODICE	EAN		
10	2100	600	180°	5000 x 8 x 1,8	-	50	<b>STC241092120</b>	8031453026912	1/2	
10	2700	750	180°	5000 x 8 x 1,8	-	50	<b>STC241092720</b>	8031453026929	1/2	
10	3000	800	180°	5000 x 8 x 1,8	-	50	<b>STC241093020</b>	8031453026936	1/2	
10	4000	850	180°	5000 x 8 x 1,8	-	50	<b>STC241094020</b>	8031453026943	1/2	
10	6000	900	180°	5000 x 8 x 1,8	-	50	<b>STC241096020</b>	8031453026950	1/2	

# COB LED STRIP IP20 48V

Striscia LED / LED Strip



- Striscia LED adesiva ad alta potenza
- Lunghezza rotolo 5/10 metri (tagliabile in corrispondenza dei punti marcati sulla striscia)
- Luce confortevole ed uniforme grazie alla tecnologia 3D SMD LED
- Accessori di connessione su richiesta

- High power adhesive LED strip
- Roll length 5/10 meters (can be cut at the points marked on the strip)
- Comfortable and uniform light thanks to 3D SMD LED technology
- Connection accessories on request



W/m	K	LUMEN lm/m		DIMENSIONE L x W x H mm	NUMERO LED/m	CUT SIZE mm	CODICE	EAN		
15	2700	1200	180°	5000 x 10 x 1,8	-	83	<b>STC481592720</b>	8031453026967	1/2	
15	2700	1200	180°	10000 x 10 x 1,8	-	83	<b>STC481592720-10</b>	8031453027001	1/2	
15	3000	1275	180°	5000 x 10 x 1,8	-	83	<b>STC481593020</b>	8031453026974	1/2	
15	3000	1275	180°	10000 x 10 x 1,8	-	83	<b>STC481593020-10</b>	8031453027018	1/2	
15	4000	1350	180°	5000 x 10 x 1,8	-	83	<b>STC481594020</b>	8031453026981	1/2	
15	4000	1350	180°	10000 x 10 x 1,8	-	83	<b>STC481594020-10</b>	8031453027025	1/2	
15	6000	1425	180°	5000 x 10 x 1,8	-	83	<b>STC481596020</b>	8031453026998	1/2	
15	6000	1425	180°	10000 x 10 x 1,8	-	83	<b>STC481596020-10</b>	8031453027032	1/2	

## COB LED STRIP IP65 48V

BTL CATEGORIA SCONTO 23

Striscia LED / LED Strip



- Striscia LED adesiva ad alta potenza
- Lunghezza rotolo 5/10 metri (non tagliabile)
- Luce confortevole ed uniforme dot free grazie alla tecnologia COB
- Accessori di connessione su richiesta
- La tecnologia Nano Coating garantisce l'indice di protezione IP65, dissipazione ottimizzata e resistente ai raggi UV

- High power adhesive LED strip
- Roll length 5/10 meters (not cuttable)
- Comfortable and uniform dot free light thanks to COB technology
- Connection accessories on request
- The Nano Coating technology guarantees the IP65 protection index, optimized dissipation and UV resistant



W/m	K	LUMEN lm/m		DIMENSIONE L x W x H mm	NUMERO LED/m	CUT SIZE mm	CODICE	EAN		
15	3000	1275	180°	5000 x 10 x 1,8	-	-	<b>STC481593065</b>	4060574754699	1/2	
15	3000	1275	180°	10000 x 10 x 1,8	-	-	<b>STC481593065-10</b>	4060574754811	1/2	
15	4000	1350	180°	5000 x 10 x 1,8	-	-	<b>STC481594065</b>	4060574754705	1/2	
15	4000	1350	180°	10000 x 10 x 1,8	-	-	<b>STC481594065-10</b>	4060574754828	1/2	

### TECNOLOGIA NANO COATING

#### NANO COATING TECHNOLOGY





IP 20

## DRIVER PER STRIP LED 12V

### 12V LED DRIVER

BTL CATEGORIA SCONTO 23

DESCRIZIONE	POTENZA MAX W	DIMENSIONI mm	CODICE	EAN		
Led driver 12V DC	15	45 x 123 x 19	LD1STRD15	8031453001889	1/10	
Led driver 12V DC	30	52 x 166 x 24	LD1STRD30	8031453001896	1/10	
Led driver 12V DC	60	52 x 180 x 30	LD1STRD60	8031453001902	1/10	

## DRIVER PER STRIP LED 24V

### 24V LED DRIVER

BTL CATEGORIA SCONTO 23

IP 20

DESCRIZIONE	POTENZA MAX W	DIMENSIONI mm	CODICE	EAN		
Led driver 24V DC	6	23 x 82 x 43	LD2STRD06	8031453019419	1/100	
Led driver 24V DC	15	19 x 123 x 45	LD2STRD15	8031453019426	1/10	
Led driver 24V DC	30	32 x 153 x 41	LD2STRD30	8031453019297	1/10	
Led driver 24V DC	60	30 x 180 x 52	LD2STRD60	8031453019303	1/10	
Led driver 24V DC	75	30 x 180 x 52	LD2STRD75	8031453019310	1/10	
Led driver 24V DC	120	40 x 300 x 30	LD2STRD120	8031453026561	1/10	

## DRIVER 24V IP67 NEW

### 24V IP67 LED DRIVER

BTL CATEGORIA SCONTO 23

IP 67

DESCRIZIONE	POTENZA MAX W	DIMENSIONI mm	CODICE	EAN		
LED Driver 24V 35Wmax IP67 compreso di connettore stagno IP68 a due vie	35	182 x 30 x 20	DRV243567	8031453035051	1/50	

## DRIVER PER STRIP LED 48V

### 48V STRIP DRIVER

BTL CATEGORIA SCONTO 23

IP 20

DESCRIZIONE	POTENZA MAX W	DIMENSIONI mm	CODICE	EAN		
Led driver 48V DC	75	52 x 180 x 30	LD3STRD75	8031453026547	1/10	
Led driver 48V DC	120	40 x 300 x 30	LD3STRD120	8031453026554	1/10	
Led driver 48V DC	150	30 x 322,5 x 21,5	LD3STRD150	4060574351034	1	

# DIMMER PER STRIP LED

## LED STRIP DIMMER

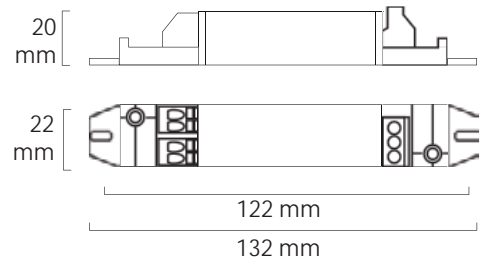

- \_ Regolatore di luminosità per driver LED in tensione 12-48Vdc
- \_ Push dimming
- \_ DALI
- \_ Dimming 1-10V
- \_ Flicker free
- \_ Tensione di alimentazione 12-48Vdc
- \_ Massima corrente d'uscita 6A

- \_ 12-48Vdc LED driver dimmer
- \_ Push dimming (slow, fast profile, up/down)
- \_ DALI
- \_ 1-10V dimming
- \_ Flicker free
- \_ Input voltage 12-48Vdc
- \_ Maximum output current 6A



POTENZA Watt	VARIANTE	CODICE	EAN	
72W@12V 144W@24V 288W@48V	Dali / push / 1-10V	DL-D/PMINI12-48	8031453032289	1/40

### DIMMING SET

Dimming	Jumper position		
	1	2	3
1-10V	ON	ON	-
Push	-	ON	ON
DALI	-	-	-



Set jumper on pin 1 and 2 position for 1-10V



Set jumper on pin 2 and 3 position for Push



None jumper on pin 1, 2 and 3 position for DALI

Schema di collegamento DALI  
Wiring diagram DALI

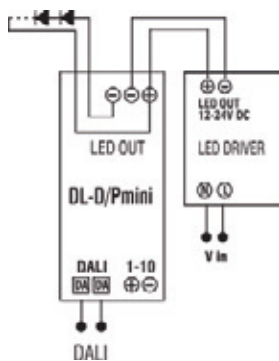

Schema di collegamento Push  
Wiring diagram Push

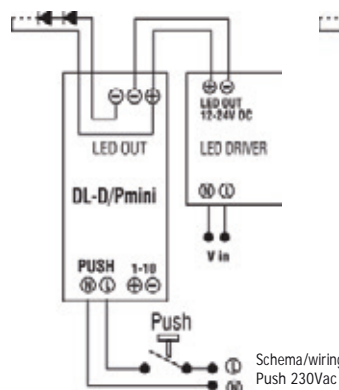

Schema di collegamento trimmer, 1/10V  
Wiring diagram trimmer, 1/10V

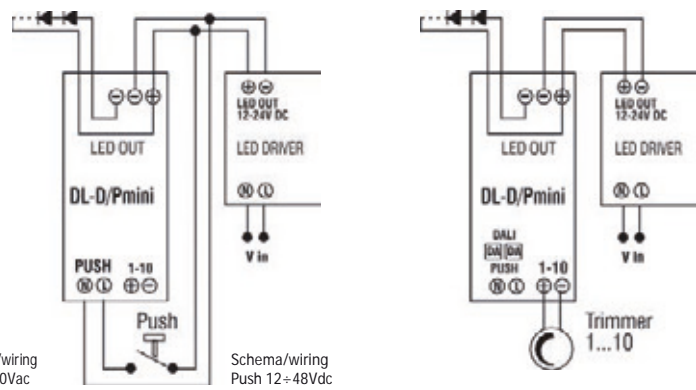

## PROFILO SLIM - 2m

### SLIM PROFILE - 2m

BTL CATEGORIA SCONTO 23

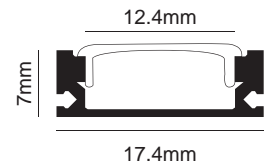



DESCRIZIONE	VARIANTE	MATERIALE	CODICE	EAN	
PROFILO SLIM IN ALLUMINIO PER LED STRIP - LUNGHEZZA 2M	ARGENTO / SILVER	ALLUMINIO / ALUMINUM	STP101A	8031453027049	1 *
PROFILO SLIM IN ALLUMINIO PER LED STRIP - LUNGHEZZA 2M	BIANCO / WHITE	ALLUMINIO / ALUMINUM	STP101B	8031453027056	1 *
PROFILO SLIM IN ALLUMINIO PER LED STRIP - LUNGHEZZA 2M	NERO /BLACK	ALLUMINIO / ALUMINUM	STP101N	8031453027063	1 *
CAPS PER PROFILO STP101 - 5 TAPPI CON FORO + 5 SENZA FORO	BIANCO / WHITE	PLASTICA / PLASTIC	STPC101B	8031453027667	1 *
CAPS PER PROFILO STP101 - 5 TAPPI CON FORO + 5 SENZA FORO	NERO /BLACK	PLASTICA / PLASTIC	STPC101N	8031453027674	1 *

## PROFILO SLIM DA INCASSO - 2m

### RECESSED SLIM PROFILE - 2m

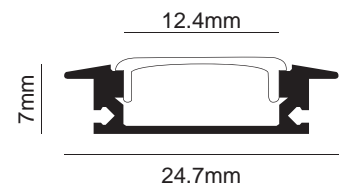
BTL CATEGORIA SCONTO 23



DESCRIZIONE	VARIANTE	MATERIALE	CODICE	EAN	
PROFILO DA INCASSO IN ALLUMINIO PER LED STRIP - LUNGHEZZA 2M	ARGENTO / SILVER	ALLUMINIO / ALUMINUM	STP201A	8031453027070	1 *
PROFILO DA INCASSO IN ALLUMINIO PER LED STRIP - LUNGHEZZA 2M	BIANCO / WHITE	ALLUMINIO / ALUMINUM	STP201B	8031453027094	1 *
PROFILO DA INCASSO IN ALLUMINIO PER LED STRIP - LUNGHEZZA 2M	NERO /BLACK	ALLUMINIO / ALUMINUM	STP201N	8031453027100	1 *
CAPS PER PROFILO STP201 - 5 TAPPI CON FORO + 5 SENZA FORO	BIANCO / WHITE	PLASTICA / PLASTIC	STPC201B	8031453027681	1 *
CAPS PER PROFILO STP201 - 5 TAPPI CON FORO + 5 SENZA FORO	NERO /BLACK	PLASTICA / PLASTIC	STPC201N	8031453027698	1 *

## DISSIPATORE - 2m

### HEATSINK - 2m

BTL CATEGORIA SCONTO 23



DESCRIZIONE	VARIANTE	MATERIALE	CODICE	EAN	
DISSIPATORE IN ALLUMINIO PER LED STRIP - LUNGHEZZA 2M	ARGENTO / SILVER	ALLUMINIO / ALUMINUM	STP102A	8031453027377	1 *

\* Profili forniti con tappi e diffusore - ordine minimo 4 pezzi / Profiles supplied with caps and diffuser - minimum order 4 pcs

## PROFILO INCASSO - 2m

### RECESSED PROFILE - 2m

BTL CATEGORIA SCONTO 23

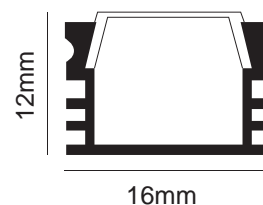



DESCRIZIONE	VARIANTE	MATERIALE	CODICE	EAN	
PROFILO DA INCASSO IN ALLUMINIO PER LED STRIP - LUNGHEZZA 2M	ARGENTO / SILVER	ALLUMINIO / ALUMINUM	STP202A	8031453027087	1 *
CAPS PER PROFILO STP202 - 5 TAPPI CON FORO + 5 SENZA FORO	BIANCO / WHITE	PLASTICA / PLASTIC	STPC202B	8031453027704	1 *

## PROFILO ANGOLARE - 2m

### CORNER PROFILE - 2m

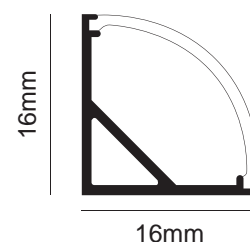
BTL CATEGORIA SCONTO 23



DESCRIZIONE	VARIANTE	MATERIALE	CODICE	EAN	
PROFILO ANGOLARE IN ALLUMINIO PER LED STRIP - LUNGHEZZA 2M	ARGENTO / SILVER	ALLUMINIO / ALUMINUM	STP301A	8031453027117	1 *
CAPS PER PROFILO STP301 - 5 TAPPI CON FORO + 5 SENZA FORO	BIANCO / WHITE	PLASTICA / PLASTIC	STPC301B	8031453027711	1 *

## PROFILO PER CARTONGESSO - 2m

### PLASTERBOARD PROFILE - 2m

BTL CATEGORIA SCONTO 23

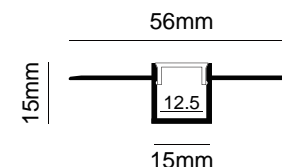
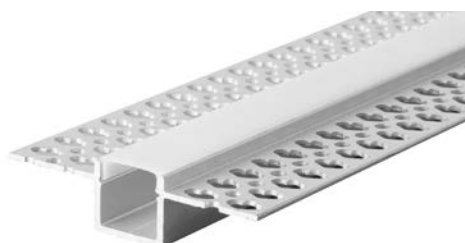

DESCRIZIONE	VARIANTE	MATERIALE	CODICE	EAN	
PROFILO PER CARTONGESSO IN ALLUMINIO PER LED STRIP - LUNGHEZZA 2M	ARGENTO / SILVER	ALLUMINIO / ALUMINUM	STP401A	8031453027124	1 **
CAPS PER PROFILO STP401 - 10 TAPPI CON FORO	BIANCO / WHITE	PLASTICA / PLASTIC	STPC401B	8031453027728	1 **

\* Profili forniti con tappi e diffusore - ordine minimo 4 pezzi / Profiles supplied with caps and diffuser - minimum order 4 pcs

\*\* Profili forniti con tappi e diffusore - ordine minimo 2 pezzi / Profiles supplied with caps and diffuser - minimum order 2 pcs

## COMPATIBILITA' ACCESSORI STRISCE

### STRIP ACCESSORIES COMPATIBILITY

	STR IP20	STR IP54	STR IP67	STC CCT	STC IP20 24V	STC IP20 48V	STC IP65
STCCA21					X		
STCCA22						X*	X*
STCCA3				X			
STRCA20	X						
STRCA54		X					
STRCA67			X				
STCCON1				X			
STCCON2				X			

\*Non è garantito il grado di protezione IP della striscia dopo il taglio e con l'uso dei connettori se non effettuato a regola d'arte.

\*The IP protection degree of the strip after cutting and with the use of the connectors is not guaranteed if not carried out in a workmanlike manner.

BTL CATEGORIA SCONTO 23

BTL CATEGORIA SCONTO 23

#### CAVETTI DI ALIMENTAZIONE PER LED STRIP COB

##### COB LED STRIP POWER CABLES

CODICE	DESCRIZIONE	EAN		
STCCA21	8 MM - 2 CAVI / 2 CABLES	8031453027629	5	
STCCA22	10 MM - 2 CAVI / 2 CABLES	8031453027636	5	

#### CAVETTI DI ALIMENTAZIONE PER LED STRIP SMD

##### SMD LED STRIP POWER CABLES

CODICE	DESCRIZIONE	EAN		
STRCA20	8 MM - 2 CAVI / 2 CABLES	8031453027599	5	
STRCA54	8 MM - 2 CAVI / 2 CABLES	8031453027605	5	
STRCA67	10,5 MM - 2 CAVI / 2 CABLES	8031453027612	5	

BTL CATEGORIA SCONTO 23

#### ACCESSORI PER STRISCIA CSP

##### CSP STRIP ACCESSORIES

CODICE	DESCRIZIONE	EAN		
STCCON1	CONTROLLER PER LED STRIP - DIP SWITCH	4060574370011	1	
STCCON2	CONTROLLER PER LED STRIP - TUYA WI-FI	4060574370172	1	
STCCA3	10 MM - 3 CAVI / 3 CABLES	8031453027643	5	

\_ L'utilizzo dei caps di isolamento e dei cavi di interconnessione non garantiscono il grado IP iniziale delle strisce, pertanto si consiglia in abbinata a tali accessori di attuare degli accorgimenti tali (isolamento con silicone o altri sistemi) da poter considerare l'installazione di grado IP adeguato al luogo dove viene realizzata.

\_ The use of insulation caps and interconnection cables do not guarantee the initial IP degree of the strips, therefore it is recommended in combination with these accessories to implement such precautions (insulation with silicone or other systems). The IP degree must be suitable for the place where the installation is made.







**TECNICO / MODULI LED**  
TECHNICAL / LED MODULES

# MOD-A CCT

BTL CATEGORIA SCONTO 23

Modulo LED circolare magnetico CCT / CCT magnetic circular LED module

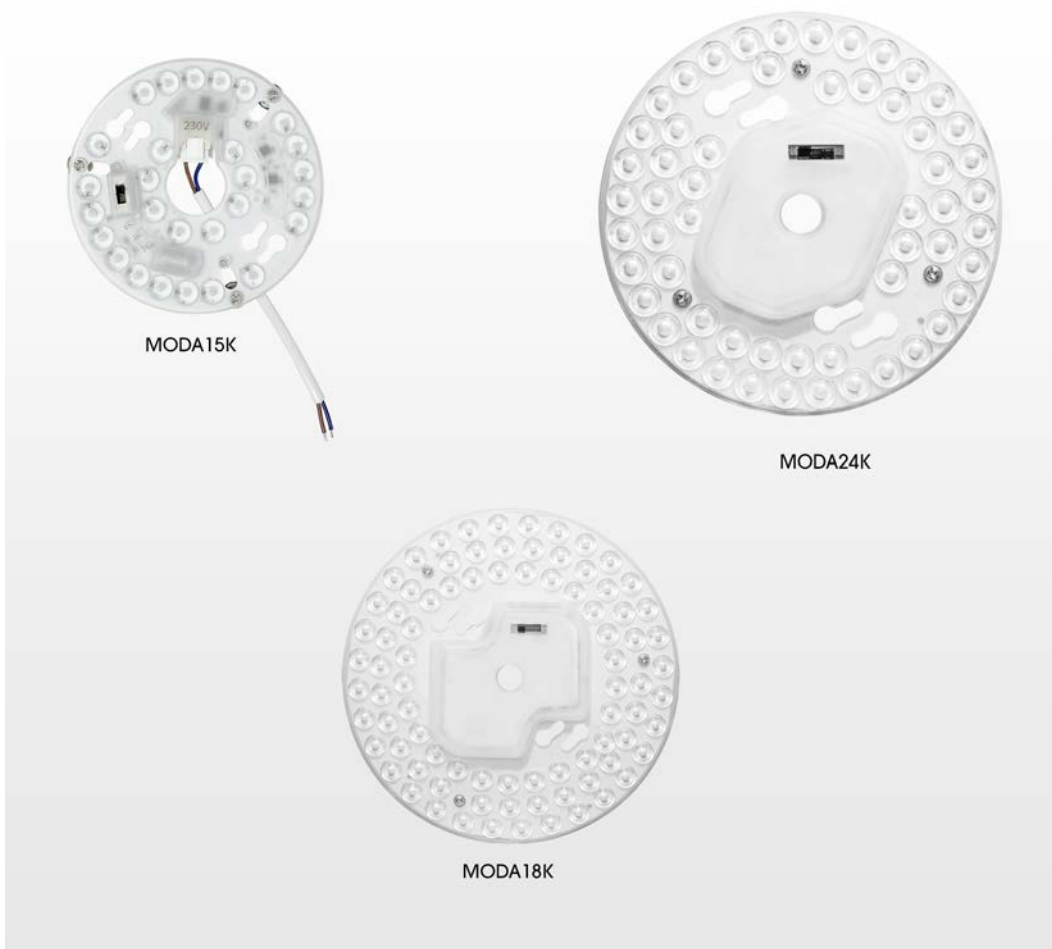

- \_ Modulo a LED con alimentatore incorporato per retrofit su plafoniere esistenti
- \_ Installazione rapida grazie a supporti magnetici, necessita solo del collegamento dell'alimentazione (isolamento classe II)
- \_ Disponibili diverse misure e potenze per adattarsi ai diversi apparecchi esistenti
- \_ CCT selezionabile

- \_ LED module with built-in driver to retrofit existing ceiling light fixtures
- \_ Quick installation thanks to magnetic supports, only requires connection to the power supply (insulation class II)
- \_ Various sizes and power outputs available to adapt to different existing luminaires
- \_ Selectable CCT



W	K	LUMEN SORGENTE lm		VARIANTE	CODICE	EAN		
15	<input type="checkbox"/> 3000 <input type="checkbox"/> 4000 <input type="checkbox"/> 6000	1500	180°	-	<b>MODA15K</b>	8031453032654	1/10	
18	<input type="checkbox"/> 3000 <input type="checkbox"/> 4000 <input type="checkbox"/> 6000	1800	180°	-	<b>MODA18K</b>	8031453032661	1/10	
24	<input type="checkbox"/> 3000 <input type="checkbox"/> 4000 <input type="checkbox"/> 6000	2400	180°	-	<b>MODA24K</b>	8031453032678	1/10	

# MOD-B

Modulo LED circolare magnetico / Magnetic circular LED module

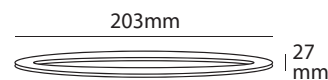

- \_ Modulo a LED con alimentatore incorporato per retrofit su plafoniere esistenti
- \_ Installazione rapida grazie a supporti magnetici, necessita solo del collegamento dell'alimentazione (isolamento classe II)
- \_ Versione con foro centrale, ideale per sostituzione in plafoniere con foro passante

- \_ LED module with built-in driver to retrofit existing ceiling light fixtures.
- \_ Quick installation thanks to magnetic supports, only requires connection to the power supply (insulation class II)
- \_ Central hole version, suitable for retrofit in pass-through hole fixtures



W	K	LUMEN APPARECCHIO lm		VARIANTE	CODICE	EAN		
20	3000	2200	160°	-	<b>MODB202B</b>	8031453021726	1/10	
20	4000	2300	160°	-	<b>MODB203B</b>	8031453021733	1/10	

# MOD-C CCT

Modulo LED circolare magnetico CCT / CCT magnetic circular LED module



Dimensioni	A	B
1	22	215
2	22	285

MODC34K

MODC24K

- \_ Modulo a LED con alimentatore incorporato per retrofit su plafoniere esistenti
- \_ Installazione rapida grazie a supporti magnetici, necessita solo del collegamento dell'alimentazione (isolamento classe II)
- \_ Disponibili diverse misure e potenze per adattarsi ai diversi apparecchi esistenti
- \_ CCT selezionabile

- \_ LED module with built-in driver to retrofit existing ceiling light fixtures.
- \_ Quick installation thanks to magnetic supports, only requires connection to the power supply (insulation class II)
- \_ Various sizes and power outputs available to adapt to different existing luminaires
- \_ Selectable CCT



W	K	LUMEN SORGENTE lm	MISURE	VARIANTE	CODICE	EAN			
24	<input type="checkbox"/> 3000 <input type="checkbox"/> 4000 <input type="checkbox"/> 6000	2800	180° 1	-	<b>MODC24K</b>	8031453033972	1/30		
34	<input type="checkbox"/> 3000 <input type="checkbox"/> 4000 <input type="checkbox"/> 6000	4200	180° 2	-	<b>MODC34K</b>	8031453033989	1/15		



# MODULO LED SLIM

## SLIM LED MODULE

BTL CATEGORIA SCONTO 23

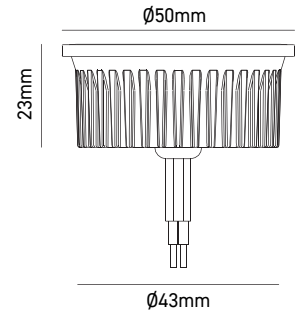

Adatto per anelli di fissaggio orientabili  
vedi pagina

Suitable for adjustable fixing rings  
see page

190-191

- \_ Adatto a anellini per sorgenti GU10
- \_ Spessore ridotto per installazioni in spazi con altezza limitata
- \_ Disponibili in due fasci di emissione e in variante dimmerabile
- \_ CCT selezionabile

- \_ Suitable for rings for GU10 light sources
- \_ Reduced thickness for installations in spaces with limited height.
- \_ Available in two beam angles and in a dimmable version
- \_ Selectable CCT



W	K	LUMEN APPARECCHIO lm	Beam Angle	VARIANTE	CODICE	EAN	Box	Energy Class	Warning
4,8	3000 4000 6500	610	38°	-	LD4SPT063K	8031453033682	10/200	A t G E	
4,8	3000 4000 6500	610	38°	DIMMERABILE / DIMMABLE *	LD4SPT063KD	8031453033699	10/200	A t G E	
5,0	3000 4000 6500	500	100°	-	LD4SPT065K	8031453033705	10/200	A t G F	
5,0	3000 4000 6500	500	100°	DIMMERABILE / DIMMABLE *	LD4SPT065KD	8031453033712	10/200	A t G F	

# MODULO LED 12-24V IP65

NEW

BTL CATEGORIA SCONTO 23

## IP65 12-24V LED MODULE

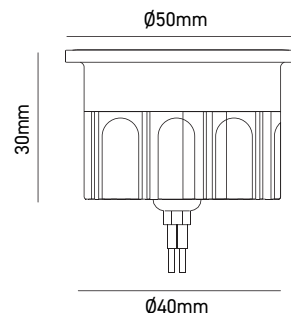

Adatto per anelli di fissaggio orientabili  
vedi pagina

Suitable for adjustable fixing rings  
see page

190-191

- \_ Adatto a anellini per sorgenti GU10
- \_ Spessore ridotto per installazioni in spazi con altezza limitata
- \_ Disponibili in due fasci di emissione
- \_ 12-24V DC e IP65 ideali per installazioni in ambienti umidi (bagni, lavanderie, ecc..)

- \_ Suitable for GU10 light sources
- \_ Reduced thickness for installations in spaces with limited height
- \_ Available in two beam angles
- \_ 12-24V DC and IP65 ideal for installations in humid environments (bathrooms, laundries, etc.)



W	K	LUMEN APPARECCHIO lm	Beam Angle	VARIANTE	CODICE	EAN	Box	Energy Class
5,5	2700	600	38°	-	MOD0632DC	8031453034955	10/200	A+G F
5,5	3000	600	38°	-	MOD0633DC	8031453034962	10/200	A+G F
5,5	2700	600	100°	-	MOD0652DC	8031453034979	10/200	A+G F
5,5	3000	600	100°	-	MOD0653DC	8031453034986	10/200	A+G F

# SEGOVIA LED

BTL CATEGORIA SCONTO 24

Accessorio / Accessory

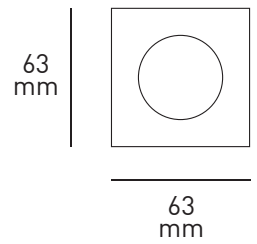

Per SEGOVIA1  
vedi pagina

For SEGOVIA1  
see page

372

- \_ Modulo LED flicker-free per SEGOVIA
- \_ Disponibile in versione 3000K e 4000K
- \_ Installazione veloce, fissaggio con viti, piastra dissipante e lente in dotazione

- \_ Flicker-free LED module for SEGOVIA
- \_ Available in versions 3000K and 4000K
- \_ Quick installation, screw fastening, heat sink and lens supplied



W	K	LUMEN APPARECCHIO lm		VARIANTE	CODICE	EAN			
10		3000	1100	180°	-	SEGOVIAMOD2	8031453020910	1	
10		4000	1250	180°	-	SEGOVIAMOD3	8031453020927	1	

# LAGOS LED

BTL CATEGORIA SCONTO 24

Accessorio / Accessory



Per LAGOS1 - LAGOS2  
vedi pagina

For LAGOS1 - LAGOS2  
see page

374-376

\_ Modulo LED flicker-free per LAGOS  
\_ CCT selezionabile

\_ Flicker-free LED module for LAGOS  
\_ Selectable CCT



W	K	LUMEN APPARECCHIO lm		VARIANTE	CODICE	EAN		
9	<input type="checkbox"/> 3000 <input type="checkbox"/> 4000 <input type="checkbox"/> 5500	1000	180°	-	LAGOSMODK	8031453032272	1	





**TECNICO / REGLETTE E  
SISTEMI COMPONENTI**  
TECHNICAL / REGLETTE AND  
MODULAR SYSTEMS

# EVA

Plafoniera flat LED CCT / CCT flat LED ceiling light

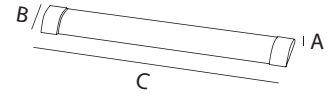

Dimensioni	A	B	C
1	25	75	600
2	25	75	1200
3	25	75	1500

- \_ Plafoniera sigillata in policarbonato
- \_ Design extra slim
- \_ Alta efficienza fino a 110 lm/W
- \_ Lunga durata grazie ai suoi materiali resistenti alla polvere e corrosione
- \_ Applicazione a soffitto o a parete
- \_ CCT selezionabile

- \_ Polycarbonate sealed ceiling light
- \_ Extra slim design
- \_ High efficiency up to 110 lm/W
- \_ Long life thanks to its dust and corrosion resistant materials
- \_ Ceiling or wall application
- \_ Selectable CCT



W	K	LUMEN APPARECCHIO lm	LUMEN SORGENTE lm	▲	MISURE	VARIANTE	CODICE	EAN			
18	<input type="checkbox"/> 3000 <input type="checkbox"/> 4500 <input type="checkbox"/> 6500	2200	2600	120°	1	-	<b>EVA18K</b>	8031453028466	1/18		<b>D</b>
36	<input type="checkbox"/> 3000 <input type="checkbox"/> 4500 <input type="checkbox"/> 6500	4300	4600	120°	2	-	<b>EVA36K</b>	8031453028473	1/18		<b>E</b>
45	<input type="checkbox"/> 3000 <input type="checkbox"/> 4500 <input type="checkbox"/> 6500	5400	6500	120°	3	-	<b>EVA45K</b>	8031453028480	1/18		<b>D</b>

# LED T5 BAR

Sistema modulare di barre LED / LED Modular system



Dimensioni	A	B	C
1	34	23	300
2	34	23	572
3	34	23	1178

Compreso cavo di alimentazione da 150mm.

Including 150mm power cable.

Barre di potenze differenti possono essere connesse tra loro per una potenza complessiva di 220W.

Bars of different wattages can be connected to each other. Total power must not exceed 220W.

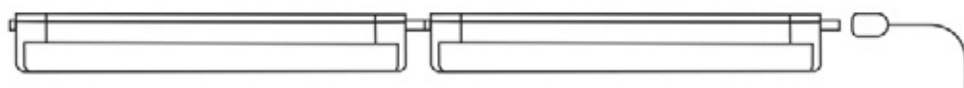

- Gamma completa di reglette a led in policarbonato con connettore integrato per giunzione diretta ed effetto lineare continuo
- Disponibili in tre misure e tre potenze
- Per ogni variante di misura e potenza, disponibile in versione 3000K e 4000K

- Complete range of polycarbonate LED light bars with an integrated connector for direct linking and continuous linear effect
- Available in three sizes and three power levels
- For each size and power variant, available in 3000K and 4000K versions



W	K	LUMEN APPARECCHIO lm	LUMEN SORGENTE lm	MISURE	VARIANTE	CODICE	EAN		
5	3000	450	500	120°	1	LD4BAR03052	8031453032579	1/25	
5	4000	500	550	120°	1	LD4BAR03053	8031453032586	1/25	
9	3000	810	900	120°	2	LD4BAR06092	8031453032593	1/25	
9	4000	900	1000	120°	2	LD4BAR06093	8031453032609	1/25	
18	3000	1650	1800	120°	3	LD4BAR12182	8031453032616	1/25	
18	4000	1800	2000	120°	3	LD4BAR12183	8031453032623	1/25	

# YGS - Switch Fisico

Reglette LED CCT con selettore / CCT LED reglette with selector

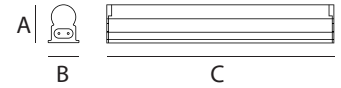

Dimensioni	A	B	C
1	34	23	300
2	34	23	572
3	34	23	880
4	34	23	1178
5	34	23	1478

Compreso cavo di alimentazione da 1,5m e cavo di interconnessione da 15cm.

Including 1,5m power cable and 15cm interconnection cable.

Barre di potenze differenti possono essere connesse tra loro per una potenza complessiva di 220W.

Bars of different wattages can be connected to each other. Total power must not exceed 220W.

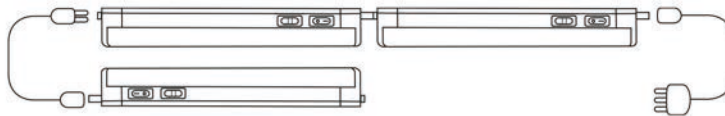

- Gamma completa di reglette a led in policarbonato con interruttore per sostituzione delle tradizionali reglette T5
- Disponibili in cinque potenze e misure
- CCT selezionabile

- Complete range of polycarbonate LED reglette with switch to replace conventional T5 reglette
- Available in five power outputs and sizes
- Selectable CCT



W	K	LUMEN APPARECCHIO lm	LUMEN SORGENTE lm	MISURE	VARIANTE	CODICE	EAN		
5	<input type="checkbox"/> 3000 <input type="checkbox"/> 4000 <input type="checkbox"/> 6500	570	630	120° 1	-	<b>YGS05KB</b>	8031453032098	1/25	
9	<input type="checkbox"/> 3000 <input type="checkbox"/> 4000 <input type="checkbox"/> 6500	1000	1150	120° 2	-	<b>YGS09KB</b>	8031453032104	1/25	
14	<input type="checkbox"/> 3000 <input type="checkbox"/> 4000 <input type="checkbox"/> 6500	1600	1800	120° 3	-	<b>YGS14KB</b>	8031453032111	1/25	
18	<input type="checkbox"/> 3000 <input type="checkbox"/> 4000 <input type="checkbox"/> 6500	2100	2300	120° 4	-	<b>YGS18KB</b>	8031453032128	1/25	
22	<input type="checkbox"/> 3000 <input type="checkbox"/> 4000 <input type="checkbox"/> 6500	2600	2850	120° 5	-	<b>YGS22KB</b>	8031453032135	1/25	

# YGQ - Switch Fisico

Reglette LED CCT con selettore / CCT LED reglette with selector

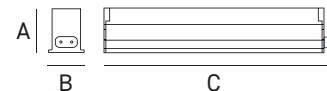

Dimensioni	A	B	C
1	30,5	23	300
2	30,5	23	572
3	30,5	23	880
4	30,5	23	1178
5	30,5	23	1478

Compreso cavo di alimentazione da 1,5m e cavo di interconnessione da 15cm.

Including 1,5m power cable and 15cm interconnection cable.

Barre di potenze differenti possono essere connesse tra loro per una potenza complessiva di 220W.

Bars of different wattages can be connected to each other. Total power must not exceed 220W.

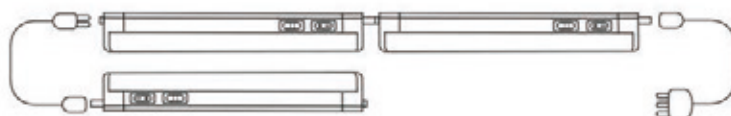

- Gamma completa di reglette a led in policarbonato con interruttore per sostituzione delle tradizionali reglette T5
- Disponibili in cinque potenze e misure
- CCT selezionabile

- Complete range of polycarbonate LED reglette with switch to replace conventional T5 reglette
- Available in five power outputs and sizes
- Selectable CCT



W	K	LUMEN APPARECCHIO lm	LUMEN SORGENTE lm	MISURE	VARIANTE	CODICE	EAN		
5	<input type="checkbox"/> 3000 <input type="checkbox"/> 4000 <input type="checkbox"/> 6500	500	550	120° 1	-	YGQ05KB	8031453032906	1/25	
9	<input type="checkbox"/> 3000 <input type="checkbox"/> 4000 <input type="checkbox"/> 6500	900	1000	120° 2	-	YGQ09KB	8031453032913	1/25	
14	<input type="checkbox"/> 3000 <input type="checkbox"/> 4000 <input type="checkbox"/> 6500	1400	1550	120° 3	-	YGQ14KB	8031453032920	1/25	
18	<input type="checkbox"/> 3000 <input type="checkbox"/> 4000 <input type="checkbox"/> 6500	1800	2000	120° 4	-	YGQ18KB	8031453032937	1/25	
22	<input type="checkbox"/> 3000 <input type="checkbox"/> 4000 <input type="checkbox"/> 6500	2200	2450	120° 5	-	YGQ22KB	8031453032944	1/25	

# YGR - Switch Fisico

BTL CATEGORIA SCONTO 23

Reglette CCT regolabile / CCT adjustable reglette

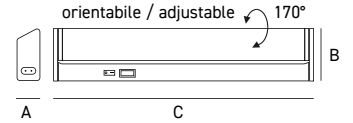

Dimensioni	A	B	C
1	24	61	297
2	24	61	545

Compreso cavo di alimentazione da 1,5m e cavo di interconnessione da 15cm.

Including 1,5m power cable and 15cm interconnection cable.

Barre di potenze differenti possono essere connesse tra loro per una potenza complessiva di 220W.

Bars of different wattages can be connected to each other. Total power must not exceed 220W.

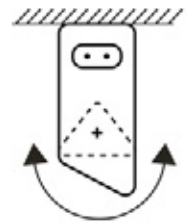
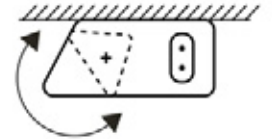
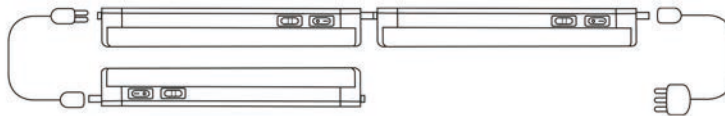

- \_ Gamma di reglette a led in policarbonato con connettore integrato per giunzione diretta
- \_ Disponibili in due potenze e misure
- \_ Diffusore orientabile
- \_ CCT selezionabile

- \_ Range of polycarbonate LED battens with integrated connector for direct joining
- \_ Available in two power levels and sizes
- \_ Adjustable diffuser
- \_ Selectable CCT



W	K	LUMEN APPARECCHIO lm	LUMEN SORGENTE lm	MISURE	VARIANTE	CODICE	EAN			
4	3000	400	550	120°	1	-	YGR04K	8031453033736	1/25	A t G D
	4000									
	6500									
8	3000	900	1100	120°	2	-	YGR08K	8031453033743	1/25	A t G D
	4000									
	6500									



**YGR**



**YGG**

# YGB

BTL CATEGORIA SCONTO 23

## Sottopensile CCT / CCT cabinet light

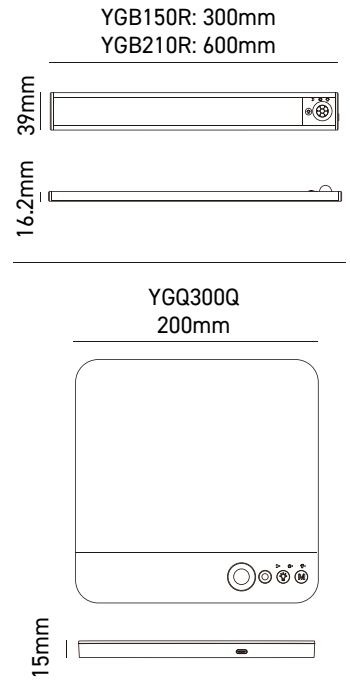

- \_ Sottopensile ricaricabile con sensore di presenza
- \_ Attacco magnetico diretto o tramite piastra magnetica adesiva in dotazione
- \_ Tre modalità di funzionamento: rilevamento di presenza e luminosità ambientale, rilevamento di presenza, sempre acceso
- \_ Intensità luminosa regolabile senza soluzione di continuità
- \_ Batteria al litio
- \_ Cavo di ricarica USB-C da 1m incluso

- \_ Rechargeable cabinet light with presence sensor
- \_ Direct magnetic attachment or via included adhesive magnetic plate
- \_ Three operating modes: presence and ambient light detection, presence detection only, always on
- \_ Stepless dimmable light intensity
- \_ Lithium battery
- \_ 1m USB-C charging cable included



W	K	LUMEN SORGENTE lm		VARIANTE	CODICE	EAN	
1.5	<input type="checkbox"/> 3000 <input type="checkbox"/> 4000 <input type="checkbox"/> 6500	150	120°	-	<b>YGB150R</b>	8031453034504	1/65
2.2	<input type="checkbox"/> 3000 <input type="checkbox"/> 4000 <input type="checkbox"/> 6500	300	120°	-	<b>YGB210R</b>	8031453034511	1/40
3.5	<input type="checkbox"/> 3000 <input type="checkbox"/> 4000 <input type="checkbox"/> 6500	400	120°	-	<b>YGB300Q</b>	8031453034528	1/50







**SHOT**  
BOT LIGHTING

**TECNICO / PLAFONIERE STAGNE**  
TECHNICAL / TRI-PROOF

# PLAFONIERA STAGNA VUOTA PER TUBI LED

## EMPTY SILM LED TRI-PROOF FOR LED TUBES

BTL CATEGORIA SCONTO 24

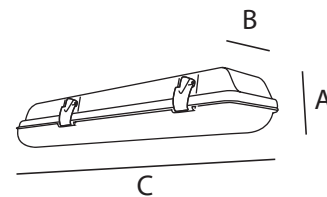

Dimensioni	A	B	C
1	76,5	65	660
2	76,5	65	1262
3	76,5	65	1562
4	76,5	95	660
5	76,5	95	1262
6	76,5	95	1562

- \_ Plafoniera stagna in materiale termoplastico ad alta resistenza meccanica con schermo in policarbonato, da utilizzare esclusivamente con tubi a Led
- \_ Fornita senza tubi
- \_ Disponibili in 6 diverse misure

- \_ Triproof ceiling light in thermoplastic material with high mechanical resistance, with polycarbonate screen, to be used exclusively with LED tubes
- \_ Without tubes
- \_ Available in 6 different sizes



VARIANTE	MISURE	CODICE	EAN	
PER UN TUBO / FOR ONE TUBE	1	<b>LD0WPF106</b>	8031453025502	1/15
PER UN TUBO / FOR ONE TUBE	2	<b>LD0WPF112</b>	8031453025519	1/15
PER UN TUBO / FOR ONE TUBE	3	<b>LD0WPF115</b>	8031453025526	1/15
PER DUE TUBI / FOR TWO TUBES	4	<b>LD0WPF206</b>	8031453025533	1/10
PER DUE TUBI / FOR TWO TUBES	5	<b>LD0WPF212</b>	8031453025540	1/10
PER DUE TUBI / FOR TWO TUBES	6	<b>LD0WPF215</b>	8031453025557	1/10

# PLAFONIERA STAGNA A LED SLIM

## SLIM LED TRI-PROOF

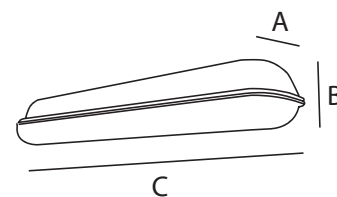

Dimensioni	A	B	C
1	78	80	650
2	78	80	1250
3	78	80	1550

- \_ Plafoniera stagna in policarbonato e ganci in acciaio inox
- \_ Design slim
- \_ Alta efficienza fino a 140 lm/W
- \_ Lunga durata grazie ai suoi materiali resistenti all'acqua, polvere e corrosione

- \_ Tri-proof in polycarbonate with stainless steel hooks
- \_ Slim design
- \_ High efficiency up to 140 lm/W
- \_ Resistant to water, dust and corrosion



W	K	LUMEN APPARECCHIO lm	LUMEN SORGENTE lm	MISURE	MISURE	VARIANTE	CODICE	EAN		
18	4000	2500	2700	120°	1	ON/OFF	<b>LD2WPF183</b>	8031453024482	1/8	
30	4000	4200	4500	120°	2	ON/OFF	<b>LD2WPF303</b>	8031453024499	1/6	
45	4000	6600	7200	120°	3	ON/OFF	<b>LD2WPF453</b>	8031453026509	1/6	
65	4000	9100	9800	120°	3	ON/OFF	<b>LD2WPF653</b>	8031453024512	1/6	
81	4000	11000	12400	120°	3	ON/OFF	<b>LD2WPF813</b>	8031453026523	1/6	

# PLAFONIERA STAGNA A LED SLIM - PASSANTE

## SLIM LED TRI-PROOF - PASS THROUGH

BTL CATEGORIA SCONTO 24

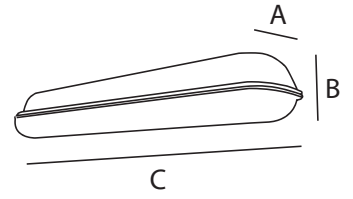

Dimensioni	A	B	C
1	78	80	1250
2	78	80	1550

- \_ Plafoniera stagna in policarbonato e ganci in acciaio inox
- \_ Design slim
- \_ Alta efficienza fino a 140 lm/W
- \_ Lunga durata grazie ai suoi materiali resistenti all'acqua, polvere e corrosione
- \_ Collegamento passante per collegare tra di loro fino a 33 pezzi di LD2WPF303L o 22 pezzi di LD2WPF453L per un totale complessivo di 1000W
- \_ Tri-proof in polycarbonate with stainless steel hooks
- \_ Slim design
- \_ High efficiency up to 140 lm/W
- \_ Resistant to water, dust and corrosion
- \_ Pass through connection in order to connect up to 33 pieces of LD2WPF303L or 22 pieces of LD2WPF453L for a total of 1000W



W	K	LUMEN APPARECCHIO lm	LUMEN SORGENTE lm	MISURE	VARIANTE	CODICE	EAN		
30	4000	4200	4500	120°	PASSANTE / PASS-THROUGH	<b>LD2WPF303L</b>	8031453024529	1/6	
45	4000	6600	7200	120°	PASSANTE / PASS-THROUGH	<b>LD2WPF453L</b>	8031453031732	1/6	

# PLAFONIERA STAGNA A LED SLIM - EMERGENZA

BTL CATEGORIA SCONTO 24

## SLIM LED TRI-PROOF - EMERGENCY

AGGIORNATO

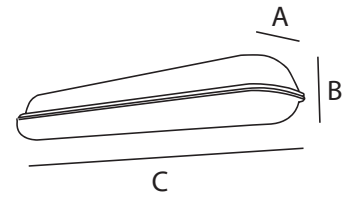

Dimensioni	A	B	C
1	78	80	1250
2	78	80	1550

- \_ Plafoniera stagna in policarbonato e ganci in acciaio inox
- \_ Design slim
- \_ Alta efficienza fino a 140 lm/W
- \_ Lunga durata grazie ai suoi materiali resistenti all'acqua, polvere e corrosione
- \_ Autonomia in emergenza 3h
- \_ Tempo di ricarica 24h
- \_ Lumen in emergenza 300lm

- \_ Tri-proof in polycarbonate with stainless steel hooks
- \_ Slim design
- \_ High efficiency up to 140 lm/W
- \_ Resistant to water, dust and corrosion
- \_ Emergency autonomy period 3h
- \_ Charging time 24h
- \_ Emergency lumen output 300lm



W	K	LUMEN APPARECCHIO lm	LUMEN SORGENTE lm		MISURE	VARIANTE	CODICE	EAN			
30	<input type="checkbox"/> 4000	4200	4500	120°	1	EMERGENZA / EMERGENCY	<b>LD2WPF303E</b>	8031453024543	1/6		
45	<input type="checkbox"/> 4000	6700	7200	120°	2	EMERGENZA / EMERGENCY	<b>LD2WPF453E</b>	8031453026516	1/6		
65	<input type="checkbox"/> 4000	9100	9800	120°	2	EMERGENZA / EMERGENCY	<b>LD2WPF653E</b>	8031453034757	1/6		NEW
81	<input type="checkbox"/> 4000	11000	12400	120°	2	EMERGENZA / EMERGENCY	<b>LD2WPF813E</b>	8031453034764	1/6		NEW

# PLAFONIERA STAGNA A LED SLIM - RADAR

## SLIM LED TRI-PROOF - RADAR

BTL CATEGORIA SCONTO 24

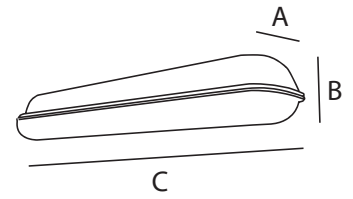
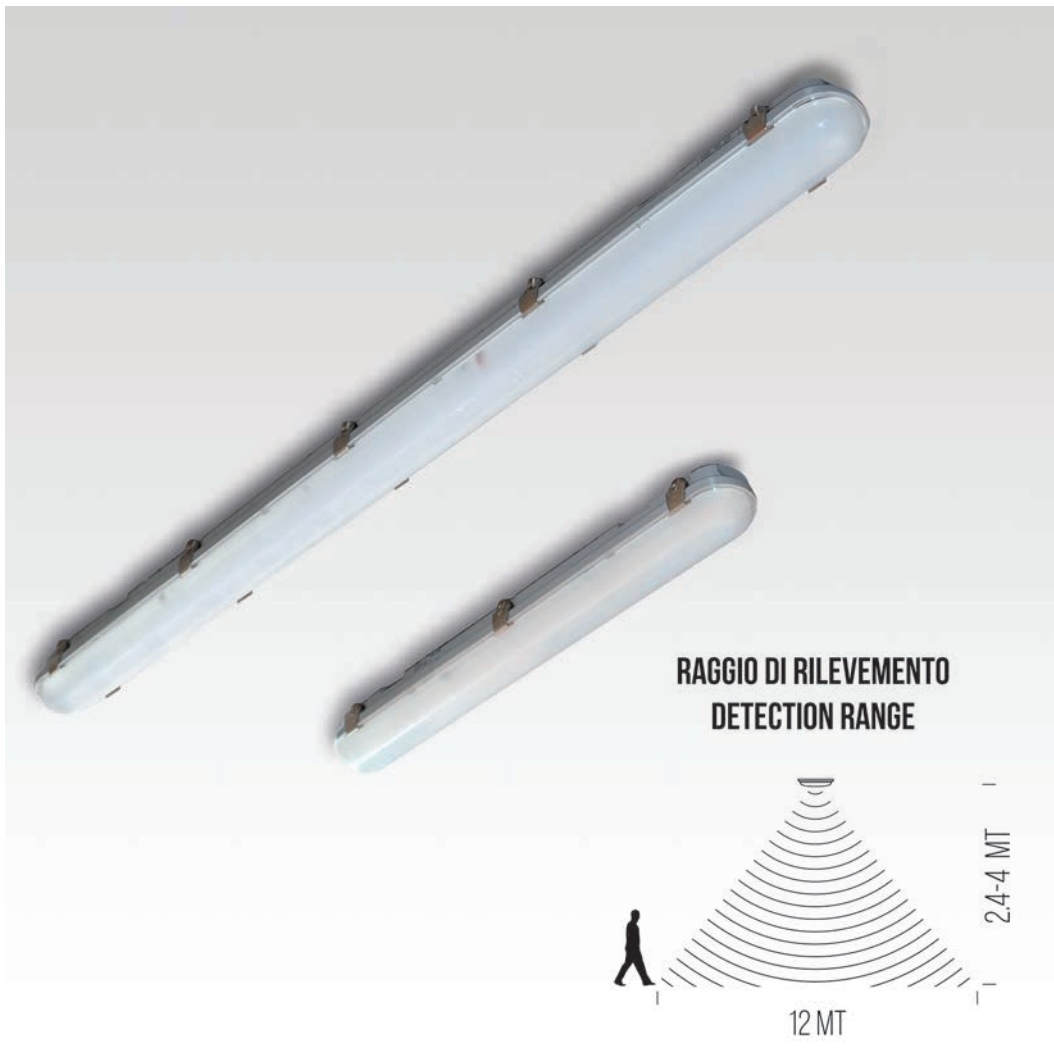

Dimensioni	A	B	C
1	78	80	650
2	78	80	1250
3	78	80	1550

- Plafoniera stagna in policarbonato e ganci in acciaio inox
- Design slim
- Alta efficienza fino a 140 lm/W
- Lunga durata grazie ai suoi materiali resistenti all'acqua, polvere e corrosione
- Sensore microonde programmabile mediante dip-switch (sensibilità, livello di luce ambiente, tempo di accensione)

- Tri-proof in polycarbonate with stainless steel hooks
- Slim design
- High efficiency up to 140 lm/W
- Resistant to water, dust and corrosion
- Option version with microwave sensor programmable by dip-switch (sensitivity, ambient light level, light switch-on time)



W	K	LUMEN APPARECCHIO lm	LUMEN SORGENTE lm	120°	MISURE	VARIANTE	CODICE	EAN	1/8	1/6	1/6
18	4000	2500	2700	120°	1	SENSORE A MICROONDE / MICROWAVE SENSOR	<b>LD2WPF183MW</b>	8031453024680	1/8	A ↑ G	D
30	4000	4200	4500	120°	2	SENSORE A MICROONDE / MICROWAVE SENSOR	<b>LD2WPF303MW</b>	8031453024574	1/6	A ↑ G	D
45	4000	6600	7200	120°	3	SENSORE A MICROONDE / MICROWAVE SENSOR	<b>LD2WPF453MW</b>	8031453027247	1/6	A ↑ G	C
65	4000	9100	9800	120°	3	SENSORE A MICROONDE / MICROWAVE SENSOR	<b>LD2WPF653MW</b>	8031453024598	1/6	A ↑ G	D
81	4000	11000	12400	120°	3	SENSORE A MICROONDE / MICROWAVE SENSOR	<b>LD2WPF813MW</b>	8031453027254	1/6	A ↑ G	D

# PLAFONIERA STAGNA A LED SLIM LD3

## LD3 SLIM LED TRI-PROOF

BTL CATEGORIA SCONTO 24

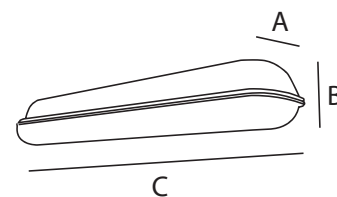

Dimensioni	A	B	C
1	66	68	600
2	66	68	1200
3	66	68	1500

- Plafoniera stagna sigillata in policarbonato
- Design slim
- Alta efficienza fino a 140 lm/W
- Lunga durata grazie ai suoi materiali resistenti all'acqua, polvere e corrosione

- Sealed tri-proof in polycarbonate
- Slim design
- High efficiency up to 140 lm/W
- Resistant to water, dust and corrosion



W	K	LUMEN APPARECCHIO lm	LUMEN SORGENTE lm	MISURE	MISURE	VARIANTE	CODICE	EAN		
18	4000	2100	2500	120°	1	-	LD3WPF183	8031453026455	1/12	
36	6500	4300	5000	120°	2	-	LD3WPF361	8031453026479	1/12	
36	4000	4300	5000	120°	2	-	LD3WPF363	8031453026462	1/12	
52	6500	6200	7200	120°	3	-	LD3WPF521	8031453026493	1/9	
52	4000	6200	7200	120°	3	-	LD3WPF523	8031453026486	1/9	





**SHOT**  
BOT LIGHTING

**TECNICO** / TECHNICAL  
HIGH BAY

# HIGH BAY LED 150

BTL CATEGORIA SCONTO 24

Proiettore High bay LED 150W / High power LED high bay 150W

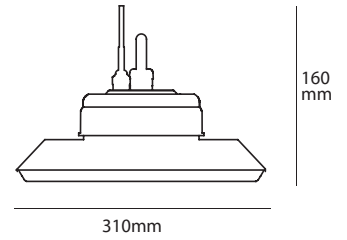

- \_ Proiettore per applicazioni industriali ideale per la sostituzione degli apparecchi tradizionali a scarica da 250W e 400W in ambienti come magazzini, capannoni o grandi superfici in genere.
- \_ Corpo in alluminio verniciato di colore nero
- \_ Alta efficienza 150 lm/W
- \_ Anello per montaggio a sospensione

- \_ Floodlight for industrial applications, ideal for replacing traditional 250W and 400W high pressure discharge lamps in large surface environments such as warehouses, industrial sheds.
- \_ Painted die-cast aluminium body
- \_ High efficiency 150 lm/W
- \_ Ring for suspension mounting



W	K	LUMEN APPARECCHIO lm	LUMEN SORGENTE lm		VARIANTE	CODICE	EAN		
150	4000	21000	22500	90°	-	LD3HB150N	8031453026097	1	

## HIGH BAY LED 200

BTL CATEGORIA SCONTO 24

Proiettore High bay LED 200W / High power LED high bay 200W

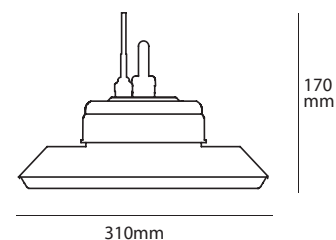

- \_ Proiettore per applicazioni industriali ideale per la sostituzione degli apparecchi tradizionali a scarica da 250W e 400W in ambienti come magazzini, capannoni o grandi superfici in genere
- \_ Corpo in alluminio verniciato di colore nero
- \_ Alta efficienza 150 lm/W
- \_ Anello per montaggio a sospensione

- \_ Floodlight for industrial applications, ideal for replacing traditional 250W and 400W high pressure discharge lamps in large surface environments such as warehouses, industrial sheds.
- \_ Painted die-cast aluminium body
- \_ High efficiency 150 lm/W
- \_ Ring for suspension mounting



W	K	LUMEN APPARECCHIO lm	LUMEN SORGENTE lm		VARIANTE	CODICE	EAN		
200	4000	28000	31000	90°	-	LD3HB200N	8031453026103	1	

# SS DOB HIGH BAY

Proiettore High Bay LED DOB / DOB LED High Bay

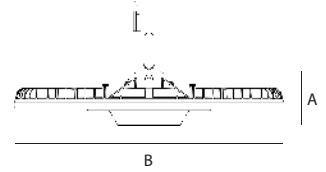

Dimensioni	A	B
1	83	240
2	83	285
3	83	315

- \_ Proiettore per applicazioni industriali ideale per la sostituzione degli apparecchi tradizionali a scarica in ambienti come magazzini, capannoni o grandi superfici in genere
- \_ Corpo in alluminio verniciato bianco RAL9003 (solo nella versione 100W) o grigio RAL9007
- \_ Alta efficienza fino a 130 lm/W
- \_ High bay a LED con tecnologia Driver On Board (DOB)
- \_ Protezione dalle sovratensioni di 4kV linea-linea
- \_ Protezione dalle sovratensioni di 6kV linea-terra

- \_ Floodlight for industrial applications, ideal for replacing traditional high pressure discharge lamps in large surface environments such as warehouses, industrial sheds.
- \_ White RAL9003 (only on 100W version) or gray RAL9007 aluminium body
- \_ High efficiency up to 130 lm/W
- \_ LED high bay with 'Driver On Board' (DOB) technology
- \_ Overvoltage protection of 4kV line-line
- \_ Overvoltage protection of 6kV line-earth



W	K	LUMEN APPARECCHIO lm	LUMEN SORGENTE lm	MISURE	VARIANTE	CODICE	EAN		
100	4000	13000	13400	110° 1	BIANCO / WHITE	LD4HB100B	8031453032173	1	A T G E
100	4000	13000	13400	110° 1	ANTRACITE / ANTHRACITE	LD4HB100G	8031453032180	1	A T G E
150	4000	19500	20000	110° 2	ANTRACITE / ANTHRACITE	LD4HB150G	8031453032197	1	A T G E
200	4000	26000	26300	110° 3	ANTRACITE / ANTHRACITE	LD4HB200G	8031453032203	1	A T G E
STAFFA PER SS DOB HIGH BAY / BRACKET FOR SS DOB HIGH BAY						LD4HBKIT	8031453032210	1	

## HIGH BAY MULTI POTENZA

NEW

BTL CATEGORIA SCONTO 24

Proiettore High Bay multi potenza dimmerabile / Dimmable multi power LED High Bay

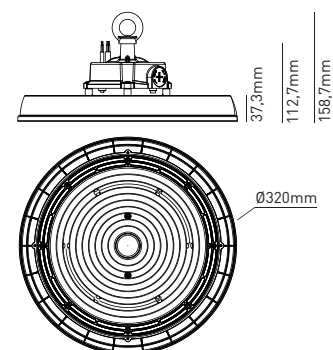

- \_ Proiettore per applicazioni industriali ideale per la sostituzione degli apparecchi tradizionali a scarica in ambienti come magazzini, capannoni o grandi superfici in genere
- \_ Alta efficienza fino a 160 lm/W
- \_ Protezione dalle sovratensioni di 6kV linea-linea
- \_ Protezione dalle sovratensioni di 6kV linea-terra
- \_ Dimmerabile 0-10V, range di dimmerazione 1-100%
- \_ Anello per montaggio a sospensione

- \_ Floodlight for industrial applications, ideal for replacing traditional high pressure discharge lamps in large surface environments such as warehouses, industrial sheds
- \_ High efficiency up to 160 lm/W
- \_ Overvoltage protection of 6kV line-line
- \_ Overvoltage protection of 6kV line-earth
- \_ 0-10V dimmable, 1-100% dimming range
- \_ Ring for suspension mounting



W	K	LUMEN APPARECCHIO lm	LUMEN SORGENTE lm		VARIANTE	CODICE	EAN		
100	4000	17000	18000	90°	-	LD5HB200N5D	8031453035419	1	
150		25000	26000						
200		33000	34000						
100	4000	17000	18000	120°	-	LD5HB200NXD	8031453035426	1	
150		25000	26000						
200		33000	34000						





**SHOT**  
BOT LIGHTING

**TECNICO / PROIETTORI**  
TECHNICAL / FLOODLIGHTS

# ORLANDO 10

BTL CATEGORIA SCONTO 24

Proiettore a Led slim / Slim Led floodlight

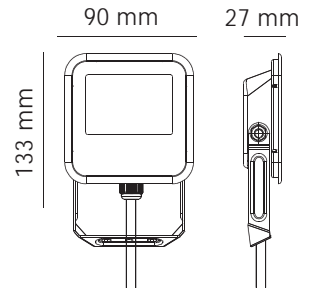

- \_ Proiettore a LED slim con tecnologia 'Driver On Board' (DOB)
- \_ Alta efficienza 110 lm/W
- \_ Corpo in alluminio verniciato e diffusore in vetro temperato
- \_ Colore bianco RAL 9016 o grigio RAL 7024
- \_ Cavo H05RN-F3G1.0mm<sup>2</sup>, lunghezza 30cm

- \_ Slim LED floodlight with 'Driver On Board' (DOB) technology
- \_ High efficiency 110 lm/W
- \_ Painted aluminum body with tempered glass diffuser
- \_ White RAL 9016 or grey RAL 7024 colors
- \_ H05RN-F3G1.0mm<sup>2</sup> cable, 30cm in length



W	K	LUMEN APPARECCHIO lm	LUMEN SORGENTE lm		VARIANTE	CODICE	EAN		
10	3000	1000	1100	120°	BIANCO / WHITE	<b>ORLANDO10B</b>	8031453023300	1/30	
10	4000	1100	1200	120°	GRIGIO GRAFITE / GRAPHITE GREY	<b>ORLANDO10G</b>	8031453023256	1/30	



**ORLANDO 10**

# ORLANDO 20

BTL CATEGORIA SCONTO 24

Proiettore a Led slim / Slim Led floodlight

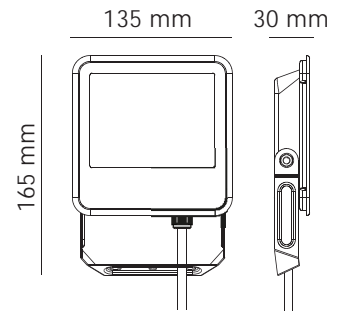

- \_ Proiettore a LED slim con tecnologia 'Driver On Board' (DOB)
- \_ Alta efficienza 110 lm/W
- \_ Corpo in alluminio verniciato e diffusore in vetro temperato
- \_ Colore bianco RAL 9016 o grigio RAL 7024
- \_ Cavo H05RN-F3G1.0mm<sup>2</sup>, lunghezza 30cm

- \_ Slim LED floodlight with 'Driver On Board' (DOB) technology
- \_ High efficiency 110 lm/W
- \_ Painted aluminum body with tempered glass diffuser
- \_ White RAL 9016 or grey RAL 7024 colors
- \_ H05RN-F3G1.0mm<sup>2</sup> cable, 30cm in length



W	K	LUMEN APPARECCHIO lm	LUMEN SORGENTE lm	◡	VARIANTE	CODICE	EAN	📦	🌱
20	3000	2100	2500	120°	☐ BIANCO / WHITE	<b>ORLANDO20B</b>	8031453023317	1/20	A ↑ G E
20	4000	2300	2650	120°	☐ BIANCO / WHITE	<b>ORLANDO20BN</b>	8031453024741	1/20	A ↑ G E
20	4000	2300	2650	120°	■ GRIGIO GRAFITE / GRAPHITE GREY	<b>ORLANDO20G</b>	8031453023263	1/20	A ↑ G E
20	6500	2300	2650	120°	■ GRIGIO GRAFITE / GRAPHITE GREY	<b>ORLANDO20GD</b>	8031453024758	1/20	A ↑ G E

# ORLANDO 20 PIR

Proiettore a Led slim / Slim Led floodlight

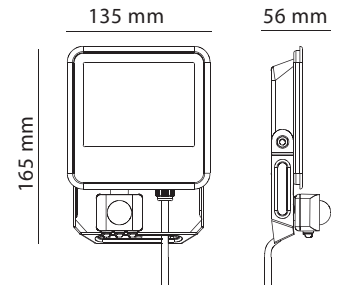

- \_ Proiettore a LED slim con tecnologia 'Driver On Board' (DOB)
- \_ Alta efficienza 110 lm/W
- \_ Corpo in alluminio verniciato e diffusore in vetro temperato
- \_ Colore grigio RAL 7024
- \_ Sensore programmabile (sensibilità al movimento, livello di luce ambiente, durata)
- \_ Cavo H05RN-F3G1.0mm<sup>2</sup>, lunghezza 30cm

- \_ Slim LED floodlight with 'Driver On Board' (DOB) technology
- \_ High efficiency 110 lm/W
- \_ Painted aluminum body with tempered glass diffuser
- \_ Grey RAL 7024 color
- \_ Programmable sensor (movement sensitivity, ambient light level, duration)
- \_ H05RN-F3G1.0mm<sup>2</sup> cable, 30cm in length



W	K	LUMEN APPARECCHIO lm	LUMEN SORGENTE lm	Beam Angle	VARIANTE	CODICE	EAN	Box	Energy Class
20	4000	2300	2650	120°	GRIGIO GRAFITE SENSORE PIR / GRAPHITE GREY PIR SENSOR	ORLANDO20GIR	8031453023355	1/20	A+ E

# ORLANDO 30

BTL CATEGORIA SCONTO 24

Proiettore a Led slim / Slim Led floodlight

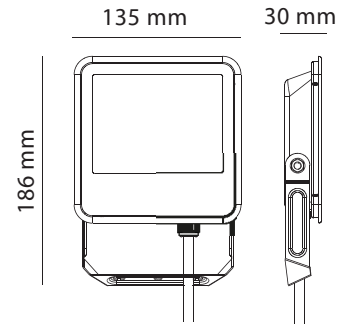

- \_ Proiettore a LED slim con tecnologia 'Driver On Board' (DOB)
- \_ Alta efficienza 110 lm/W
- \_ Corpo in alluminio verniciato e diffusore in vetro temperato
- \_ Colore bianco RAL 9016 o grigio RAL 7024
- \_ Cavo H05RN-F3G1.0mm<sup>2</sup>, lunghezza 30cm

- \_ Slim LED floodlight with 'Driver On Board' (DOB) technology
- \_ High efficiency 110 lm/W
- \_ Painted aluminum body with tempered glass diffuser
- \_ White RAL 9016 or grey RAL 7024 colors
- \_ H05RN-F3G1.0mm<sup>2</sup> cable, 30cm in length



W	K	LUMEN APPARECCHIO lm	LUMEN SORGENTE lm		VARIANTE	CODICE	EAN			
30		3000	3150	3550	120°	BIANCO / WHITE	<b>ORLANDO30B</b>	8031453023324	1/20	
30		4000	3450	3750	120°	GRIGIO GRAFITE / GRAPHITE GREY	<b>ORLANDO30G</b>	8031453023270	1/20	
30		4000	3450	3750	120°	BIANCO / WHITE	<b>ORLANDO30BN</b>	8031453024765	1/20	
30		6500	3450	3750	120°	GRIGIO GRAFITE / GRAPHITE GREY	<b>ORLANDO30GD</b>	8031453024772	1/20	

# ORLANDO 30 PIR

Proiettore a Led slim / Slim Led floodlight

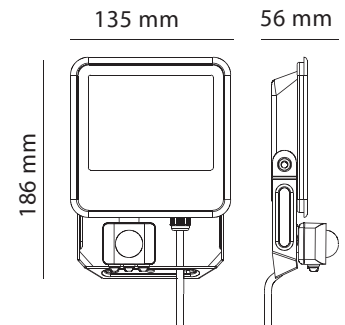

- \_ Proiettore a LED slim con tecnologia 'Driver On Board' (DOB)
- \_ Alta efficienza 110 lm/W
- \_ Corpo in alluminio verniciato e diffusore in vetro temperato
- \_ Colore grigio RAL 7024
- \_ Sensore programmabile (sensibilità al movimento, livello di luce ambiente, durata)
- \_ Cavo H05RN-F3G1.0mm<sup>2</sup>, lunghezza 30cm

- \_ Slim LED floodlight with 'Driver On Board' (DOB) technology
- \_ High efficiency 110 lm/W
- \_ Painted aluminum body with tempered glass diffuser
- \_ Grey RAL 7024 color
- \_ Programmable sensor (movement sensitivity, ambient light level, duration)
- \_ H05RN-F3G1.0mm<sup>2</sup> cable, 30cm in length



W	K	LUMEN APPARECCHIO lm	LUMEN SORGENTE lm	Beam angle	VARIANTE	CODICE	EAN	Box icon	Energy label icon
30	4000	3450	3750	120°	GRIGIO GRAFITE SENSORE PIR / GRAPHITE GREY PIR SENSOR	ORLANDO30GIR	8031453023362	1/20	A+ E

# ORLANDO 50

BTL CATEGORIA SCONTO 24

Proiettore a Led slim / Slim Led floodlight

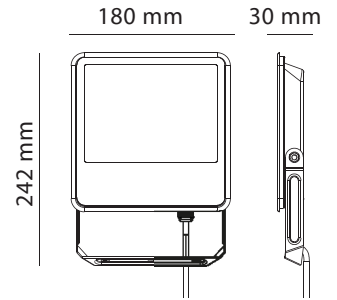

- \_ Proiettore a LED slim con tecnologia 'Driver On Board' (DOB)
- \_ Alta efficienza 110 lm/W
- \_ Corpo in alluminio verniciato e diffusore in vetro temperato
- \_ Colore bianco RAL 9016 o grigio RAL 7024
- \_ Cavo H05RN-F3G1.0mm<sup>2</sup>, lunghezza 30cm

- \_ Slim LED floodlight with 'Driver On Board' (DOB) technology
- \_ High efficiency 110 lm/W
- \_ Painted aluminum body with tempered glass diffuser
- \_ White RAL 9016 or grey RAL 7024 colors
- \_ H05RN-F3G1.0mm<sup>2</sup> cable, 30cm in length



W	K	LUMEN APPARECCHIO lm	LUMEN SORGENTE lm		VARIANTE	CODICE	EAN		
50	3000	5500	6350	120°	BIANCO / WHITE	<b>ORLANDO50B</b>	8031453023331	1/10	
50	4000	6000	6700	120°	BIANCO / WHITE	<b>ORLANDO50BN</b>	8031453024789	1/10	
50	4000	6000	6700	120°	GRIGIO GRAFITE / GRAPHITE GREY	<b>ORLANDO50G</b>	8031453023287	1/10	
50	6500	6000	6700	120°	GRIGIO GRAFITE / GRAPHITE GREY	<b>ORLANDO50GD</b>	8031453024796	1/10	

# ORLANDO 50 PIR

Proiettore a Led slim / Slim Led floodlight

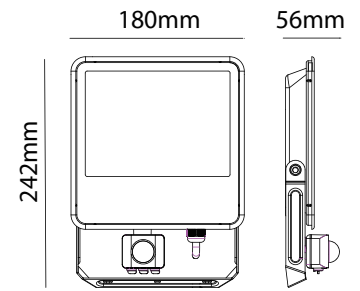

- \_ Proiettore a LED slim con tecnologia 'Driver On Board' (DOB)
- \_ Alta efficienza 110lm/W
- \_ Corpo in alluminio verniciato e diffusore in vetro temperato
- \_ Colore grigio RAL 7024
- \_ Sensore programmabile (sensibilità al movimento, livello di luce ambiente, durata)
- \_ Cavo H05RN-F3G1.0mm<sup>2</sup>, lunghezza 30cm

- \_ Slim LED floodlight with 'Driver On Board' (DOB) technology
- \_ High efficiency 110 lm/W
- \_ Painted aluminum body with tempered glass diffuser
- \_ Grey RAL 7024 color
- \_ Programmable sensor (movement sensitivity, ambient light level, duration)
- \_ H05RN-F3G1.0mm<sup>2</sup> cable, 30cm in length



W	K	LUMEN APPARECCHIO lm	LUMEN SORGENTE lm		VARIANTE	CODICE	EAN		
50	<input type="checkbox"/> 4000	6000	6500	120°	<input checked="" type="checkbox"/> GRIGIO GRAFITE / GRAPHITE GREY	ORLANDO50GIR	8031453031794	1/10	A t G E

# ORLANDO 90

BTL CATEGORIA SCONTO 24

Proiettore a Led slim / Slim Led floodlight

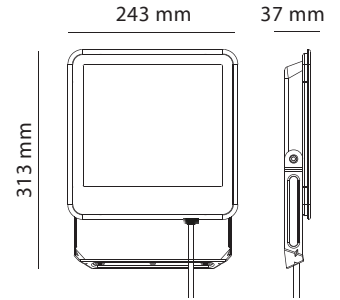

- \_ Proiettore a LED slim con tecnologia 'Driver On Board' (DOB)
  - \_ Alta efficienza 110 lm/W
  - \_ Corpo in alluminio verniciato e diffusore in vetro temperato
  - \_ Colore bianco RAL 9016 o grigio RAL 7024
  - \_ Valvola di sfogo per evitare la formazione di condensa all'interno del proiettore
  - \_ Cavo H05RN-F3G1.0mm<sup>2</sup>, lunghezza 30cm
- \_ Slim LED floodlight with 'Driver On Board' (DOB) technology
  - \_ High efficiency 110 lm/W
  - \_ Painted aluminum body with tempered glass diffuser
  - \_ White RAL 9016 or grey RAL 7024 colors
  - \_ External vent to avoid condensation inside the projector
  - \_ H05RN-F3G1.0mm<sup>2</sup> cable, 30cm in length



W	K	LUMEN APPARECCHIO lm	LUMEN SORGENTE lm		VARIANTE	CODICE	EAN			
90		3000	9900	11600	120°	<input type="checkbox"/> BIANCO / WHITE	<b>ORLANDO90B</b>	8031453023348	1/5	
90	<input type="checkbox"/>	4000	10800	12600	120°	<input type="checkbox"/> BIANCO / WHITE	<b>ORLANDO90BN</b>	8031453024802	1/5	
90	<input type="checkbox"/>	4000	10800	12600	120°	<input checked="" type="checkbox"/> GRIGIO GRAFITE / GRAPHITE GREY	<b>ORLANDO90G</b>	8031453023294	1/5	
90		6500	10800	12600	120°	<input checked="" type="checkbox"/> GRIGIO GRAFITE / GRAPHITE GREY	<b>ORLANDO90GD</b>	8031453024819	1/5	



**ORLANDO 90**

# ORLANDO 150

BTL CATEGORIA SCONTO 24

Proiettore a Led slim / Slim Led floodlight

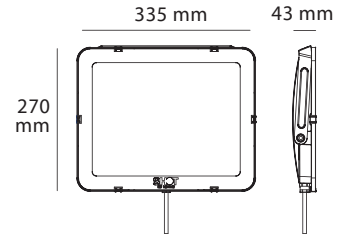

- \_ Proiettore a LED slim con tecnologia 'Driver On Board' (DOB)
- \_ Alta efficienza 110 lm/W
- \_ Corpo in alluminio verniciato e diffusore in vetro temperato
- \_ Colore grigio RAL 7024
- \_ Valvola integrata per espulsione della condensa
- \_ Cavo H05RN-F3G1.0mm<sup>2</sup>, lunghezza 50cm

- \_ Slim LED floodlight with 'Driver On Board' (DOB) technology
- \_ High efficiency 110 lm/W
- \_ Painted aluminum body with tempered glass diffuser
- \_ Grey RAL 7024 color
- \_ Integrated valve in order to avoid condensation
- \_ H05RN-F3G1.0mm<sup>2</sup> cable, 50cm in length



W	K	LUMEN APPARECCHIO lm	LUMEN SORGENTE lm	Beam angle icon	VARIANTE	CODICE	EAN	Box icon	Energy icon	ATE icon
150	4000	16500	18300	120°	GRIGIO GRAFITE / GRAPHITE GREY	ORLANDO150G	8031453025564	1/5	A T G	E

# ORLANDO 200

BTL CATEGORIA SCONTO 24

Proiettore a Led slim / Slim Led floodlight

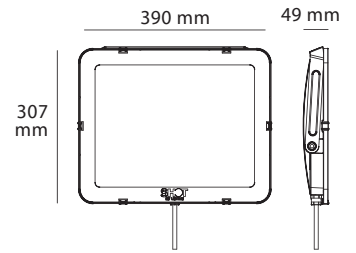

- \_ Proiettore a LED slim con tecnologia 'Driver On Board' (DOB)
- \_ Alta efficienza 110 lm/W
- \_ Corpo in alluminio verniciato e diffusore in vetro temperato
- \_ Colore grigio RAL 7024
- \_ Valvola integrata per espulsione della condensa
- \_ Cavo H05RN-F3G1.0mm<sup>2</sup>, lunghezza 50cm

- \_ Slim LED floodlight with 'Driver On Board' (DOB) technology
- \_ High efficiency 110 lm/W
- \_ Painted aluminum body with tempered glass diffuser
- \_ Grey RAL 7024 color
- \_ Integrated valve in order to avoid condensation
- \_ H05RN-F3G1.0mm<sup>2</sup> cable, 50cm in length



W	K	LUMEN APPARECCHIO lm	LUMEN SORGENTE lm	Beam Angle	VARIANTE	CODICE	EAN	Box	Energy
200	4000	22000	24500	120°	GRIGIO GRAFITE / GRAPHITE GREY	ORLANDO200G	8031453025571	1	A t G E

# KYOTO 100

BTL CATEGORIA SCONTO 24

Proiettore a Led professionale / Professional Led floodlight

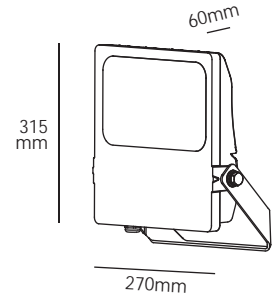

Accessorio testa per palo  
Pole adaptor



Accessorio morsa per palo  
Clamp bracket

- \_ Proiettore a LED professionale
- \_ Alta efficienza 150 lm/W
- \_ Corpo in alluminio pressofuso verniciato e diffusore in vetro temperato
- \_ Disponibile con cinque differenti fasci: Asimmetrico 26°x60° e 50°x120°, Concentrato 25° e 60°, Flood 120°
- \_ Valvola di sfogo per evitare la formazione di condensa all'interno del proiettore
- \_ Indice di protezione IP66
- \_ Protezione dalle sovratensioni di 6kV linea-linea
- \_ Protezione dalle sovratensioni di 6kV linea-terra
- \_ Colore RAL9006

- \_ Professional LED projector
- \_ High efficiency 150 lm/W
- \_ Body in painted die-cast aluminum and diffuser in tempered glass
- \_ Available with five different beams, Asymmetrical 26°x60° and 50°x120°, Concentrated 25° and 60° and Flood 120°
- \_ External vent to avoid condensation inside the projector
- \_ Protection index IP66
- \_ Overvoltage protection of 6kV line-line
- \_ Overvoltage protection of 6kV line-earth
- \_ RAL9006 color



W	K	LUMEN APPARECCHIO lm	LUMEN SORGENTE lm		VARIANTE	CODICE	EAN		
100	<input type="checkbox"/> 4000	15000	16600	25°	CONCENTRATO / CONCENTRATED	<b>KYOTO1002G</b>	8031453034139	1	
100	<input type="checkbox"/> 4000	15000	16600	60°	CONCENTRATO / CONCENTRATED	<b>KYOTO1004G</b>	8031453023416	1	
100	<input type="checkbox"/> 4000	15000	16600	120°	FLOOD	<b>KYOTO1005G</b>	8031453023423	1	
100	<input type="checkbox"/> 4000	15000	16600	26x60°	ASIMMETRICO / ASYMMETRIC	<b>KYOTO100NG</b>	8031453034146	1	
100	<input type="checkbox"/> 4000	15000	16600	50x120°	ASIMMETRICO / ASYMMETRIC	<b>KYOTO100AG</b>	8031453023430	1	
TESTA PALO PER PROIETTORE - POLE ADAPTOR						<b>KYOTO-TP60</b>	8031453023614	1/10	
MORSA PALO PER PROIETTORE - CLAMP BRACKET						<b>KYOTO-M150</b>	8031453023621	1/10	

# KYOTO 150

BTL CATEGORIA SCONTO 24

Proiettore a Led professionale / Professional Led floodlight

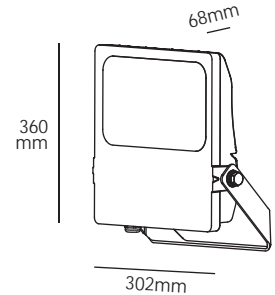

Accessorio testa per palo  
Pole adaptor

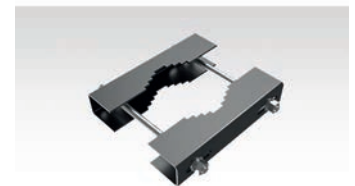

Accessorio morsa per palo  
Clamp bracket

- \_ Proiettore a LED professionale
  - \_ Alta efficienza 150 lm/W
  - \_ Corpo in alluminio pressofuso verniciato e diffusore in vetro temperato
  - \_ Disponibile con cinque differenti fasci: Asimmetrico 26°x60° e 50°x120°, Concentrato 25° e 60°, Flood 120°
  - \_ Valvola di sfogo per evitare la formazione di condensa all'interno del proiettore
  - \_ Indice di protezione IP66
  - \_ Protezione dalle sovratensioni di 6kV linea-linea
  - \_ Protezione dalle sovratensioni di 6kV linea-terra
  - \_ Colore RAL9006
- \_ Professional LED projector
  - \_ High efficiency 150 lm/W
  - \_ Body in painted die-cast aluminum and diffuser in tempered glass
  - \_ Available with five different beams, Asymmetrical 26°x60° and 50°x120°, Concentrated 25° and 60° and Flood 120°
  - \_ External vent to avoid condensation inside the projector
  - \_ Protection index IP66
  - \_ Overvoltage protection of 6kV line-line
  - \_ Overvoltage protection of 6kV line-earth
  - \_ RAL9006 color



W	K	LUMEN APPARECCHIO lm	LUMEN SORGENTE lm		VARIANTE	CODICE	EAN		
150	<input type="checkbox"/> 4000	22500	24800	25°	CONCENTRATO / CONCENTRATED	<b>KYOTO1502G</b>	8031453034153	1	
150	<input type="checkbox"/> 4000	22500	24800	60°	CONCENTRATO / CONCENTRATED	<b>KYOTO1504G</b>	8031453023461	1	
150	<input type="checkbox"/> 4000	22500	24800	120°	FLOOD	<b>KYOTO1505G</b>	8031453023478	1	
150	<input type="checkbox"/> 4000	22500	24800	26x60°	ASIMMETRICO / ASYMMETRIC	<b>KYOTO150NG</b>	8031453034160	1	
150	<input type="checkbox"/> 4000	22500	24800	50x120°	ASIMMETRICO / ASYMMETRIC	<b>KYOTO150AG</b>	8031453023485	1	
TESTA PALO PER PROIETTORE - POLE ADAPTOR						<b>KYOTO-TP60</b>	8031453023614	1/10	
MORSA PALO PER PROIETTORE - CLAMP BRACKET						<b>KYOTO-M150</b>	8031453023621	1/10	

# KYOTO 200

BTL CATEGORIA SCONTO 24

Proiettore a Led professionale / Professional Led floodlight

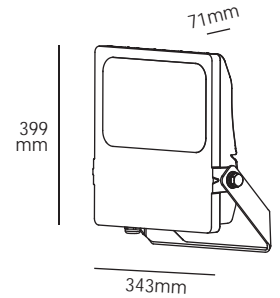

Accessorio testa per palo  
Pole adaptor

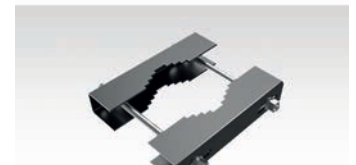

Accessorio morsa per palo  
Clamp braket

- \_ Proiettore a LED professionale
- \_ Alta efficienza 150 lm/W
- \_ Corpo in alluminio pressofuso verniciato e diffusore in vetro temperato
- \_ Disponibile con cinque differenti fasci: Asimmetrico 26°x60° e 50°x120°, Concentrato 25° e 60°, Flood 120°
- \_ Valvola di sfogo per evitare la formazione di condensa all'interno del proiettore
- \_ Indice di protezione IP66
- \_ Protezione dalle sovratensioni di 6kV linea-linea
- \_ Protezione dalle sovratensioni di 6kV linea-terra
- \_ Colore RAL9006

- \_ Professional LED projector
- \_ High efficiency 150 lm/W
- \_ Body in painted die-cast aluminum and diffuser in tempered glass
- \_ Available with five different beams, Asymmetrical 26°x60° and 50°x120°, Concentrated 25° and 60° and Flood 120°
- \_ External vent to avoid condensation inside the projector
- \_ Protection index IP66
- \_ Overvoltage protection of 6kV line-line
- \_ Overvoltage protection of 6kV line-earth
- \_ RAL9006 color



W	K	LUMEN APPARECCHIO lm	LUMEN SORGENTE lm	Beam Angle	VARIANTE	CODICE	EAN	Box	Energy
200	4000	30000	33500	25°	CONCENTRATO / CONCENTRATED	<b>KYOTO2002G</b>	8031453034177	1	A T G D
200	4000	30000	33500	60°	CONCENTRATO / CONCENTRATED	<b>KYOTO2004G</b>	8031453023515	1	A T G D
200	4000	30000	33500	120°	FLOOD	<b>KYOTO2005G</b>	8031453023522	1	A T G D
200	4000	30000	33500	26x60°	ASIMMETRICO / ASYMMETRIC	<b>KYOTO200NG</b>	8031453034184	1	A T G D
200	4000	30000	33500	50x120°	ASIMMETRICO / ASYMMETRIC	<b>KYOTO200AG</b>	8031453023539	1	A T G D
TESTA PALO PER PROIETTORE - POLE ADAPTOR						<b>KYOTO-TP60</b>	8031453023614	1/10	
MORSA PALO PER PROIETTORE - CLAMP BRACKET						<b>KYOTO-M300</b>	8031453023638	1/10	

# KYOTO 300

BTL CATEGORIA SCONTO 24

Proiettore a Led professionale / Professional Led floodlight

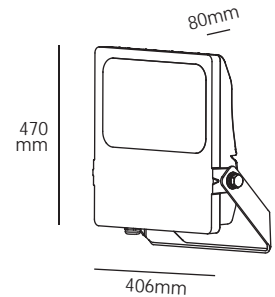

Accessorio testa per palo  
Pole adaptor



Accessorio morsa per palo  
Clamp bracket

- \_ Proiettore a LED professionale
  - \_ Alta efficienza 150 lm/W
  - \_ Corpo in alluminio pressofuso verniciato e diffusore in vetro temperato
  - \_ Disponibile con cinque differenti fasci: Asimmetrico 26°x60° e 50°x120°, Concentrato 25° e 60°, Flood 120°
  - \_ Valvola di sfogo per evitare la formazione di condensa all'interno del proiettore
  - \_ Indice di protezione IP66
  - \_ Protezione dalle sovratensioni di 6kV linea-linea
  - \_ Protezione dalle sovratensioni di 6kV linea-terra
  - \_ Colore RAL9006
- \_ Professional LED projector
  - \_ High efficiency 150 lm/W
  - \_ Body in painted die-cast aluminum and diffuser in tempered glass
  - \_ Available with five different beams, Asymmetrical 26°x60° and 50°x120°, Concentrated 25° and 60° and Flood 120°
  - \_ External vent to avoid condensation inside the projector
  - \_ Protection index IP66
  - \_ Overvoltage protection of 6kV line-line
  - \_ Overvoltage protection of 6kV line-earth
  - \_ RAL9006 color



W	K	LUMEN APPARECCHIO lm	LUMEN SORGENTE lm		VARIANTE	CODICE	EAN		
300	<input type="checkbox"/> 4000	45000	46200	25°	CONCENTRATO / CONCENTRATED	<b>KYOTO3002G</b>	8031453034191	1	
300	<input type="checkbox"/> 4000	45000	46200	60°	CONCENTRATO / CONCENTRATED	<b>KYOTO3004G</b>	8031453023560	1	
300	<input type="checkbox"/> 4000	45000	46200	120°	FLOOD	<b>KYOTO3005G</b>	8031453023577	1	
300	<input type="checkbox"/> 4000	45000	46200	26x60°	ASIMMETRICO / ASYMMETRIC	<b>KYOTO300NG</b>	8031453034207	1	
300	<input type="checkbox"/> 4000	45000	46200	120x50°	ASIMMETRICO / ASYMMETRIC	<b>KYOTO300AG</b>	8031453023584	1	
TESTA PALO PER PROIETTORE - POLE ADAPTOR						<b>KYOTO-TP60</b>	8031453023614	1/10	
MORSA PALO PER PROIETTORE - CLAMP BRACKET						<b>KYOTO-M300</b>	8031453023638	1/10	

# KYOTO 500

BTL CATEGORIA SCONTO 24

Proiettore a Led professionale / Professional Led floodlight

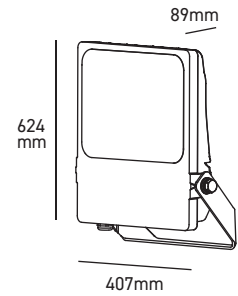

Accessorio testa per palo  
Pole adaptor



Accessorio morsa per palo  
Clamp bracket

- \_ Proiettore a LED professionale
  - \_ Alta efficienza 160 lm/W
  - \_ Corpo in alluminio pressofuso verniciato e diffusore in vetro temperato
  - \_ Disponibile con cinque differenti fasci: Asimmetrico 26°x60° e 50°x120°, Concentrato 25° e 60°, Flood 120°
  - \_ Valvola di sfogo per evitare la formazione di condensa all'interno del proiettore
  - \_ Indice di protezione IP66
  - \_ Protezione dalle sovratensioni di 10kV linea-linea
  - \_ Protezione dalle sovratensioni di 20kV linea-terra
  - \_ Colore RAL9006
- \_ Professional LED projector
  - \_ High efficiency 160 lm/W
  - \_ Body in painted die-cast aluminum and diffuser in tempered glass
  - \_ Available with five different beams, Asymmetrical 26°x60° and 50°x120°, Concentrated 25° and 60° and Flood 120°
  - \_ External vent to avoid condensation inside the projector
  - \_ Protection index IP66
  - \_ Overvoltage protection of 10kV line-line
  - \_ Overvoltage protection of 20kV line-earth
  - \_ RAL9006 color



W	K	LUMEN APPARECCHIO lm	LUMEN SORGENTE lm		VARIANTE	CODICE	EAN		
500	<input type="checkbox"/> 4000	77500	80400	25°	CONCENTRATO / CONCENTRATED	<b>KYOTO5002G</b>	8031453034214	1	
500	<input type="checkbox"/> 4000	77500	80400	60°	CONCENTRATO / CONCENTRATED	<b>KYOTO5004G</b>	8031453034412	1	
500	<input type="checkbox"/> 4000	77500	80400	120°	FLOOD	<b>KYOTO5005G</b>	8031453033996	1	
500	<input type="checkbox"/> 4000	77500	80400	26x60°	ASIMMETRICO / ASYMMETRIC	<b>KYOTO500NG</b>	8031453034221	1	
500	<input type="checkbox"/> 4000	77500	80400	120x50°	ASIMMETRICO / ASYMMETRIC	<b>KYOTO500AG</b>	8031453034009	1	
TESTA PALO PER PROIETTORE - POLE ADAPTOR						<b>KYOTO-TP60</b>	8031453023614	1/10	
MORSA PALO PER PROIETTORE - CLAMP BRACKET						<b>KYOTO-M300</b>	8031453023638	1/10	



**KYOTO**

# ATLANTA CCT

BTL CATEGORIA SCONTO 24

Proiettore a Led / Led floodlight

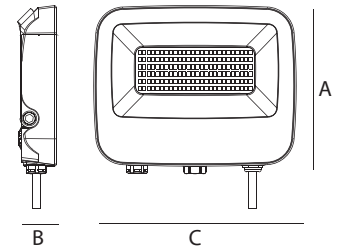

Dimensioni	A	B	C
1	124	32	148
2	137	32	165
3	80	65	50



**ATLANTAPIRB**  
accessorio / accessory  
Sensore PIR con telecomando  
PIR sensor with remote controller

- \_ Corpo in alluminio pressofuso verniciato e diffusore in vetro temperato
- \_ Valvola di sfogo per evitare la formazione di condensa all'interno del proiettore
- \_ Opzionale ATLANTAPIRB: sensore PIR con telecomando. Aggiornate le modalità di funzionamento rispetto alla versione precedente
- \_ CCT selezionabile
- \_ Painted aluminum body with tempered glass diffuser
- \_ External vent to avoid condensation inside the projector
- \_ Optional ATLANTAPIRB: remote controlled PIR sensor. Updated function compared to the previous version
- \_ Selectable CCT



W	K	LUMEN APPARECCHIO lm	MISURE	VARIANTE	CODICE	EAN			
30	<input type="checkbox"/> 3000 <input type="checkbox"/> 4000 <input type="checkbox"/> 6000	3300	120° 1	■ NERO / BLACK	ATLANTA30NK	8031453032234	1/24		
50	<input type="checkbox"/> 3000 <input type="checkbox"/> 4000 <input type="checkbox"/> 6000	5500	120° 2	■ NERO / BLACK	ATLANTA50NK	8031453032241	1/20		
ACCESSORIO SENSORE PIR-B / PIR-B SENSOR ACCESSORY					ATLANTAPIRB	8031453032258	1		



#### FUNZIONAMENTO

I proiettori ATLANTA si possono abbinare al sensore ATLANTAPIRB venduto separatamente, sensore di presenza PIR comandabile con telecomando.

Una volta installato il sensore, tramite l'apposito telecomando si potrà comandare il proiettore ed impostarne modalità e parametri tramite i relativi tasti funzione:

- POWER ON per accendere il proiettore che resterà acceso per 15s e poi si imposterà all'ultima modalità utilizzata
- DAYLIGHT ONLY: disabilita il funzionamento del sensore di movimento, rimane attivo solo il sensore crepuscolare
- SENSOR ON per attivare il sensore di presenza PIR impostato con i parametri dell'ultima modalità utilizzata
- SENSOR OFF per bypassare il sensore PIR e utilizzare il proiettore in modalità ON/OFF
- MODE 1: il proiettore si accende al 100% quando viene rilevato movimento, passato il tempo di accensione prescelto il proiettore si spegnerà finché non verrà rilevato ulteriore movimento
- MODE 2: il proiettore si accende al 100% quando viene rilevato movimento, passato il tempo di accensione prescelto il proiettore rimarrà acceso al 10% dell'emissione luminosa finché non verrà rilevato ulteriore movimento
- MODE 3: il proiettore si accende al 100% quando viene rilevato movimento, passato il tempo di accensione prescelto il proiettore rimarrà acceso al 20% dell'emissione luminosa finché non verrà rilevato ulteriore movimento
- HOLD TIME: per impostare il tempo di accensione del proiettore al 100% nelle diverse modalità
- DAY-LIGHT LEVEL: per impostare il livello di luce ambientale al quale il proiettore si accenderà
- SENSITIVITY: per impostare il raggio di rilevamento del sensore (25% raggio minimo, 100% raggio massimo)
- RESET: ripristino delle impostazioni di default: viene attivata la MODE 1, tempo di accensione al 100% per 30s, livello di luce ambientale 20lux e raggio di rilevamento 50%

Se viene tolta tensione al proiettore, lo stesso si riaccenderà in modalità ON/OFF fino alla pressione di un tasto del telecomando.

Ogni volta che viene premuto un tasto il proiettore lampeggia una volta per confermare la ricezione del comando.

#### OPERATION

The ATLANTA projectors can be equipped with ATLANTAPIRB sensor sold separately, a PIR presence sensor that can be controlled via remote control.

Once the sensor has been installed, using the remote control you can control the floodlight setting functioning modes and parameters using the function keys:

- POWER ON the projector turns on 15s by default and then enters the last mode it was set to
- DAYLIGHT ONLY: disable the operation of the motion sensor, only the twilight sensor remains active
- SENSOR ON to activate tPIR sensor, the projector enters the last mode it was set to
- SENSOR OFF to bypassed the sensor operation, the projector is set to ON/OFF mode
- MODE 1: the projector will turn on at 100% when motion is detected, after the chosen power-on time it will turn off until motion is detected
- MODE 2: the projector will turn on at 100% when motion is detected, after the chosen power-on time it will stay on at 10% of the luminous flux until motion is detected
- MODE 3: the projector will turn on at 100% when motion is detected, after the chosen power-on time it will stay on at 20% of the luminous flux until motion is detected
- HOLD TIME: set the hold time of the projector when in 100% phase
- DAY-LIGHT LEVEL: set the ambient light level at which the projector will start operating
- SENSITIVITY : set the detection range of the sensor (25% minimum range, 100% maximum range)
- RESET: Restore factory settings: MODE 1 is activated, 100% emission hold time for 30s, daylight sensitivity 20lux and motion sensitivity 50%

When the main power is turned off, the projector will turn back on in ON/OFF mode until a key is pressed.

Each time a key is pressed, the projector flashes once to confirm receipt of the command.

# AKRON 2

BTL CATEGORIA SCONTO 24

Proiettore a Led 12/24V / 12/24V Led floodlight

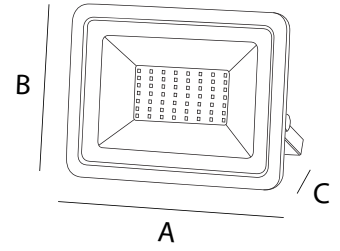

Dimensioni	A	B	C
1	124	100	24
2	159	122	26

- Corpo in alluminio pressofuso verniciato e diffusore in vetro temperato
- Funzionamento a 12-24V , ideale per imbarcazioni, camper e tutte le applicazioni in bassissima tensione

- Painted aluminum body with tempered glass diffuser
- 12-24V fixture, ideal for boats, campers and all low voltage applications



W	K	LUMEN APPARECCHIO lm	LUMEN SORGENTE lm	MISURE	VARIANTE	CODICE	EAN			
20	4000	1500	2000	120°	1	-	AKRONII20NLV	8031453029104	1/40	ATG F
30	4000	2300	3000	120°	2	-	AKRONII30NLV	8031453029111	1/30	ATG F



**AKRON 2**



**SHOT**  
BOT LIGHTING

**RESIDENZIALE / INTERNI & SOFFITTO**  
RESIDENTIAL / CEILING & INTERIOR

# LOFT35

BTL CATEGORIA SCONTO 23

Lampada a sospensione / pendant lamp

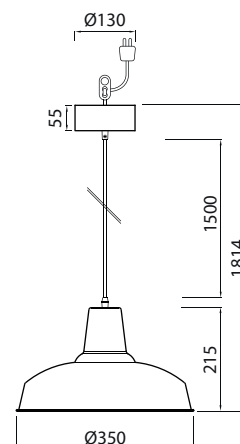

\_ Incluso cavo da 1,5 metri e coppa da soffitto  
\_ Attacco E27 per sorgenti LED max 20W

\_ Supplied with 1.5-meters fabric power cord and ceiling cup  
\_ E27 base for LED light sources max 20W



W	BASE		VARIANTE	CODICE	EAN	
-	E27	-	<input type="checkbox"/> BIANCO / WHITE	<b>9783080</b>	6435200235985	1
-	E27	-	<input checked="" type="checkbox"/> NERO / BLACK	<b>9783081</b>	6435200236005	1



**LOFT**



**SANSA**

## SANSA

BTL CATEGORIA SCONTO 23

Lampada a sospensione / pendant lamp

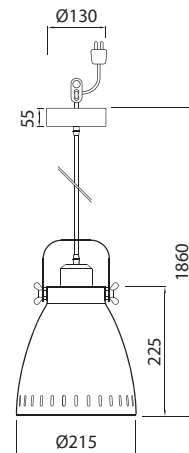

- \_ Incluso cavo da 1,5 metri e coppa da soffitto
- \_ Attacco E27 per sorgenti LED max 20W

- \_ Supplied with 1.5-meters fabric power cord and ceiling cup
- \_ E27 base for LED light sources max 20W



W	BASE		VARIANTE	CODICE	EAN	
-	E27	-	<input type="checkbox"/> BIANCO / WHITE	<b>4118754</b>	6435200226525	1/6
-	E27	-	<input checked="" type="checkbox"/> NERO / BLACK	<b>4126225</b>	6435200238207	1/6

# URBAN

BTL CATEGORIA SCONTO 23

Lampada a sospensione / Pendant lamp

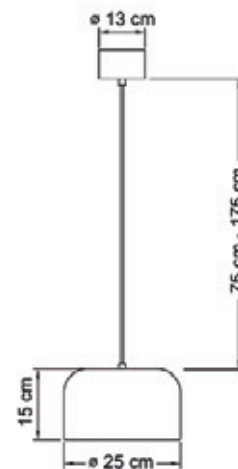

\_ Incluso cavo fino a 1,75 metri e coppa da soffitto  
\_ Attacco E27 per sorgenti LED max 20W

\_ Supplied with 1,75 meters fabric power cord and ceiling cup  
\_ E27 base for LED light sources max 20W



W	BASE		VARIANTE	CODICE	EAN	
-	E27	-	<input type="checkbox"/> BIANCO / WHITE	<b>9610559</b>	6435200300706	1/2
-	E27	-	<input checked="" type="checkbox"/> NERO / BLACK	<b>9610560</b>	6435200300713	1/2



**URBAN**



**SHOT**  
BOT LIGHTING

**RESIDENZIALE / TAVOLO E PAVIMENTO**  
RESIDENTIAL / FLOOR & TABLE

# URBAN DESK S

BTL CATEGORIA SCONTO 23

Lampada da tavolo / Table lamp



- \_ Elegante lampada da tavolo dall'aspetto moderno
- \_ Attacco E27 per sorgenti LED max 20W (si consiglia l'utilizzo di lampade di tipo sfera)
- \_ Cavo rivestito in tessuto da 1,8 metri

- \_ *Elegant table lamp with a modern look*
- \_ *E27 base for LED light sources max 20W (P45 shaped bulbs recommended)*
- \_ *1.8 meters fabric power cord*

IP 20

220-240V



W	BASE		VARIANTE	CODICE	EAN	
-	E27	-	<input type="checkbox"/> BIANCO / WHITE	<b>9610563</b>	6435200300744	1/2
-	E27	-	<input checked="" type="checkbox"/> NERO / BLACK	<b>9610564</b>	6435200300751	1/2



**URBAN DESK S**



**URBAN DESK L**

## URBAN DESK L

BTL CATEGORIA SCONTO 23

Lampada da tavolo / Table lamp

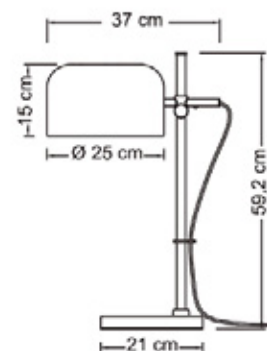

- \_ Elegante lampada da tavolo dall'aspetto moderno
- \_ Attacco E27 per sorgenti LED max 20W
- \_ Cavo rivestito in tessuto da 1,8 metri

- \_ *Elegant table lamp with a modern look*
- \_ *E27 base for LED light sources max 20W*
- \_ *1.8 meters fabric power cord*



W	BASE		VARIANTE	CODICE	EAN	
-	E27	-	 BIANCO / WHITE	<b>9610567</b>	6435200300782	1/2
-	E27	-	 NERO / BLACK	<b>9610568</b>	6435200300799	1/2

# URBAN FLOOR

BTL CATEGORIA SCONTO 23

Lampada da terra / Floor lamp

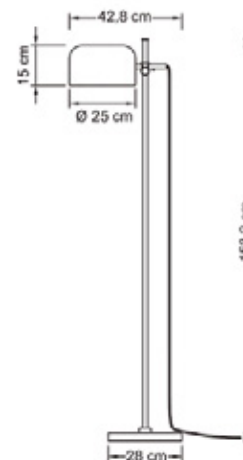

- \_ Elegante lampada da terra dall'aspetto moderno
- \_ Attacco E27 per sorgenti LED max 20W
- \_ Cavo rivestito in tessuto da 1,8 metri

- \_ *Elegant floor lamp with a modern look*
- \_ *E27 base for LED light sources max 20W*
- \_ *1.8 meters fabric power cord*



W	BASE		VARIANTE	CODICE	EAN	
-	E27	-	<input type="checkbox"/> BIANCO / WHITE	<b>9610571</b>	6435200300829	1/2
-	E27	-	<input checked="" type="checkbox"/> NERO / BLACK	<b>9610572</b>	6435200300836	1/2



**URBAN FLOOR**

# CARA LED CLIP

BTL CATEGORIA SCONTO 23



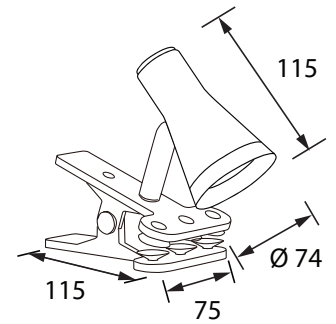

Lampada con fissaggio a clip / Clip wall lamp



- \_ Elegante applique con sistema di aggancio a clip dall'aspetto moderno per interni.
- \_ Fascio orientabile grazie allo snodo presente nello stelo.
- \_ Interruttore su cavo.

- \_ *Elegant table lamp with a modern look for indoors.*
- \_ *Adjustable beam thanks to the joint in the stem.*
- \_ *Switch on cable.*



W	K	LUMEN APPARECCHIO lm	VARIANTE	CODICE	EAN		
4,5	 3000	320	CLIP	9610414	6435200271938	1/24	

## CARA LED WALL

BTL CATEGORIA SCONTO 23



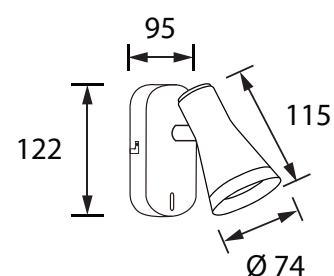
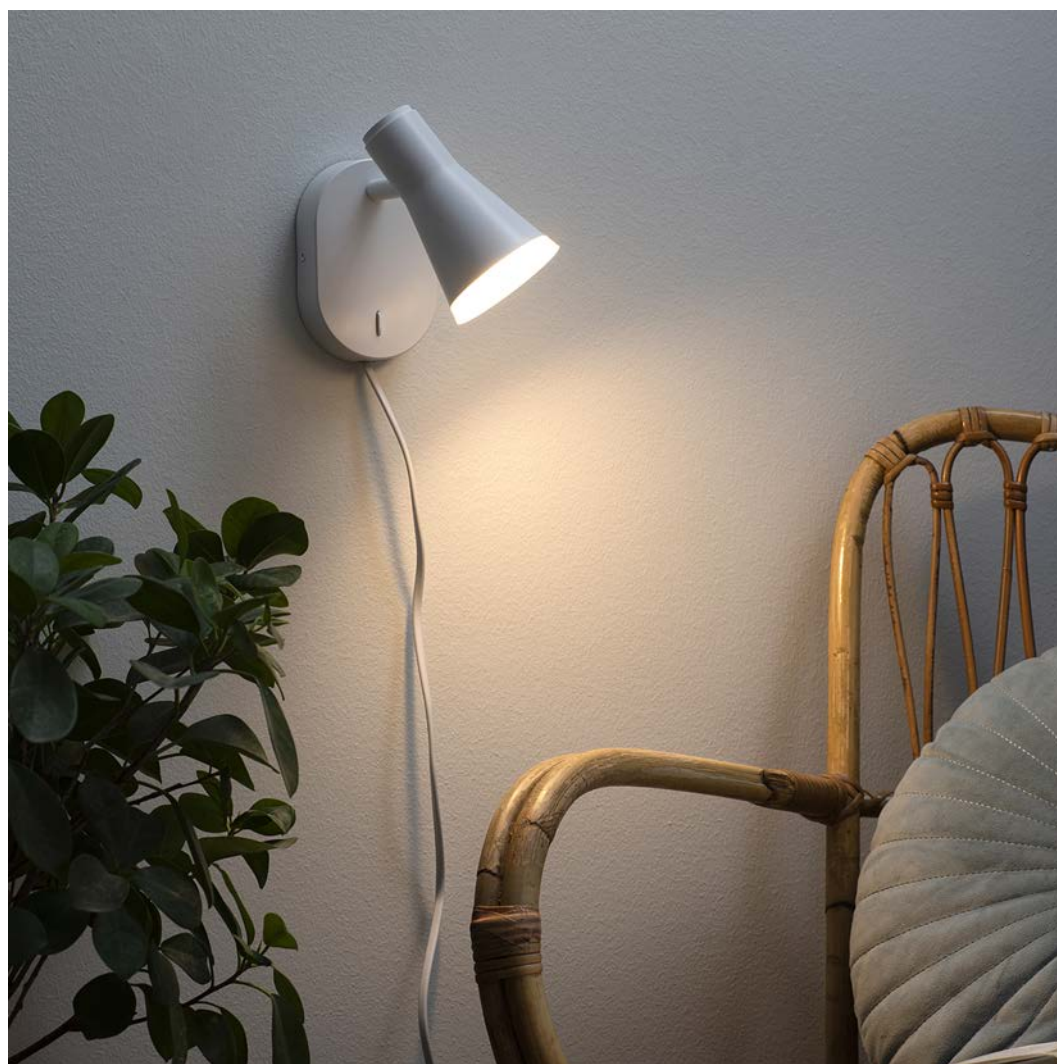

Applique / Wall lamp



- \_ Elegante applique dall'aspetto moderno per interni.
- \_ Fascio orientabile grazie allo snodo presente nello stelo.
- \_ Interruttore su cavo.

- \_ *Elegant wall light with a modern look for indoors.*
- \_ *Adjustable beam thanks to the joint in the stem.*
- \_ *Switch on cable.*



W	K	LUMEN APPARECCHIO lm	VARIANTE	CODICE	EAN		
4,5	 3000	320	WALL	9610415	6435200271976	1/24	

# CARA LED TABLE

BTL CATEGORIA SCONTO 23

Lampada da tavolo / Table lamp

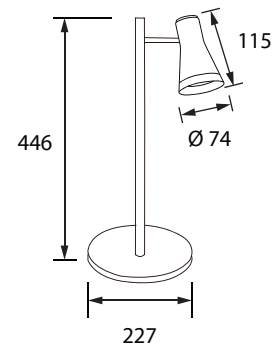

\_ Elegante lampada da tavolo dall'aspetto moderno per interni.  
\_ Fascio orientabile grazie allo snodo presente nello stelo.

\_ *Elegant table lamp with a modern look for indoors.*  
\_ *Adjustable beam thanks to the joint in the stem.*





IP 20

220-240V



25.000h  
3 ANNI GARANZIA



W	K	LUMEN APPARECCHIO lm	VARIANTE	CODICE	EAN		
4,5	 3000	320	STAND	9610413	6435200271891	1/12	



**CARA LED TABLE**



**SHOT**  
BOT LIGHTING

**RESIDENZIALE / LAMPADE DA TAVOLO  
RICARICABILI**  
RESIDENTIAL / RECHARGEABLE  
TABLE LAMPS

# SAN

BTL CATEGORIA SCONTO 23

Lampada da tavolo ricaricabile / Rechargeable table lamp

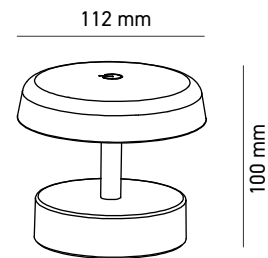

- \_ Lampada da tavolo a batteria ricaricabile IP44
- \_ Corpo in ABS
- \_ Completa di cavo di alimentazione USB-C da 1m (alimentatore non incluso)
- \_ Superficie touch di accensione e regolazione della luce
- \_ Batteria al litio
- \_ Tempo di ricarica 3 ore
- \_ Tempo di funzionamento da 3,5 a 60 ore (a seconda della dimmerazione)

- \_ IP44 rechargeable battery table lamp
- \_ ABS body
- \_ Supplied with 1m USB-C power cable (power adapter not included)
- \_ Touch surface for power on and light adjustment
- \_ Lithium battery
- \_ Charging time 3 hours
- \_ Operating time from 3,5 to 60 hours (depending on dimming)



W	K	LUMEN APPARECCHIO lm	VARIANTE	CODICE	EAN	
0.8	3000	80	BIANCO / WHITE	<b>SAN-B</b>	8031453031862	1/27
0.8	3000	80	NERO / BLACK	<b>SAN-N</b>	8031453031886	1/27
Cavo di ricarica USB-A - USB-C 1m / USB-A - USB-C charging cable 1m				<b>CABLETL</b>	8031453032340	1
HUB di ricarica USB - 10 porte - 50W/ USB charging HUB - 10 ports - 50W				<b>HUBTL50</b>	8031453033033	1



HUB di ricarica USB - 10 porte - 50W/  
USB charging HUB - 10 ports - 50W

**HUBTL50**



**SAN**

# EMMA

Lampada da tavolo ricaricabile / Rechargeable table lamp

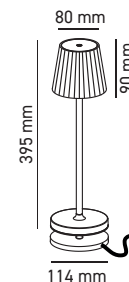

















Base di ricarica / Charging base



- \_ Lampada da tavolo a batteria ricaricabile IP54
- \_ Corpo in alluminio e diffusore in policarbonato
- \_ Completa di base di ricarica magnetica con cavo di alimentazione USB da 1,5m (alimentatore non incluso)
- \_ Superficie touch di accensione e regolazione della luce
- \_ Batteria al litio
- \_ Tempo di ricarica 6 ore
- \_ Tempo di funzionamento da 9 a 48 ore (a seconda della dimmerazione)

- \_ IP54 rechargeable battery table lamp
- \_ Aluminum body and polycarbonate diffuser
- \_ Supplied with 1.5m USB cabled magnetic charging base (power adapter not included)
- \_ Touch surface for power on and light adjustment
- \_ Lithium battery
- \_ 6 hours charging time
- \_ Operating time from 9 to 48 hours (depending on dimming)



W	K	LUMEN APPARECCHIO lm	VARIANTE	CODICE	EAN	
3		3000	250  CARTA DA ZUCCHERO / PASTEL BLUE	<b>EMMA-A</b>	8031453028404	1/8
3		3000	250  BIANCO / TRAFFIC WHITE	<b>EMMA-B</b>	8031453031176	1/8
3		3000	250  CORTEN	<b>EMMA-C</b>	8031453031169	1/8
3		3000	250  AVORIO / LIGHT IVORY	<b>EMMA-I</b>	8031453028411	1/8
3		3000	250  NERO / TRAFFIC BLACK	<b>EMMA-N</b>	8031453031183	1/8
3		3000	250  BLU PETROLIO / OCEAN BLUE	<b>EMMA-P</b>	8031453028381	1/8
3		3000	250  ROSSO LAMPONE / RASPBERRY RED	<b>EMMA-R</b>	8031453028398	1/8
3		3000	250  VERDE SALVIA / PALE GREEN	<b>EMMA-V</b>	8031453028374	1/8
Base di ricarica / Charging base				<b>EMMACB</b>	8031453032319	1
Base di ricarica multipla 12 posti / Multiple charging base 12 places				<b>EMMACB12</b>	8031453032333	1
HUB di ricarica USB - 10 porte - 50W/ USB charging HUB - 10 ports - 50W				<b>HUBTL50</b>	8031453033033	1



Base di ricarica multipla 12 posti /  
Multiple charging base 12 places  
**EMMACB12**

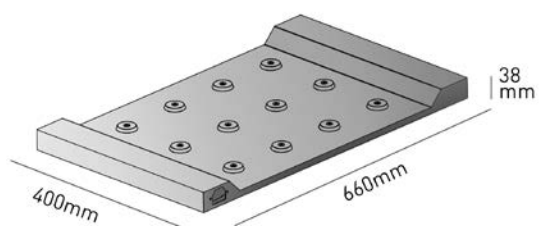

HUB di ricarica USB - 10 porte - 50W/  
USB charging HUB - 10 ports - 50W  
**HUBTL50**



# EMMA MINI

BTL CATEGORIA SCONTO 23

Lampada da tavolo ricaricabile / Rechargeable table lamp

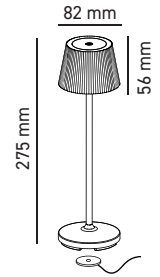

















Base di ricarica / Charging base



- Lampada da tavolo a batteria ricaricabile IP54
- Corpo in alluminio e diffusore in policarbonato
- Completa di base di ricarica magnetica con cavo di alimentazione USB da 1,5m (alimentatore non incluso)
- Superficie touch di accensione e regolazione della luce
- Batteria al litio
- Tempo di ricarica 6 ore
- Tempo di funzionamento da 9 a 48 ore (a seconda della dimmerazione)

- IP54 rechargeable battery table lamp
- Aluminum body and polycarbonate diffuser
- Supplied with 1.5m USB cabled magnetic charging base (power adapter not included)
- Touch surface for power on and light adjustment
- Lithium battery
- 6 hours charging time
- Operating time from 9 to 48 hours (depending on dimming)



W	K	LUMEN APPARECCHIO lm	VARIANTE	CODICE	EAN	
1,5	 3000	130	 CARTA DA ZUCCHERO / PASTEL BLUE	<b>EMMAMINI-A</b>	8031453031213	1/12
1,5	 3000	130	 BIANCO / TRAFFIC WHITE	<b>EMMAMINI-B</b>	8031453031220	1/12
1,5	 3000	130	 CORTEN	<b>EMMAMINI-C</b>	8031453031237	1/12
1,5	 3000	130	 AVORIO / LIGHT IVORY	<b>EMMAMINI-I</b>	8031453031244	1/12
1,5	 3000	130	 NERO / TRAFFIC BLACK	<b>EMMAMINI-N</b>	8031453031251	1/12
1,5	 3000	130	 BLU PETROLIO / OCEAN BLUE	<b>EMMAMINI-P</b>	8031453031268	1/12
1,5	 3000	130	 ROSSO LAMPONE / RASPBERRY RED	<b>EMMAMINI-R</b>	8031453031275	1/12
1,5	 3000	130	 VERDE SALVIA / PALE GREEN	<b>EMMAMINI-V</b>	8031453031282	1/12
Base di ricarica / Charging base				<b>EMMAMINICB</b>	8031453032326	1
Base di ricarica multipla 12 posti / Multiple charging base 12 places				<b>EMMACB12</b>	8031453032333	1
HUB di ricarica USB - 10 porte - 50W/ USB charging HUB - 10 ports - 50W				<b>HUBTL50</b>	8031453033033	1



Base di ricarica multipla 12 posti /  
Multiple charging base 12 places  
**EMMACB12**

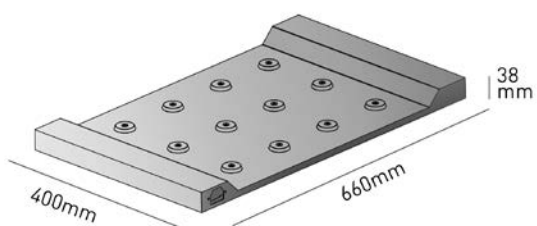

HUB di ricarica USB - 10 porte - 50W/  
USB charging HUB - 10 ports - 50W  
**HUBTL50**



**EMMA MINI**

# MAYA

BTL CATEGORIA SCONTO 23

Lampada da tavolo ricaricabile / Rechargeable table lamp

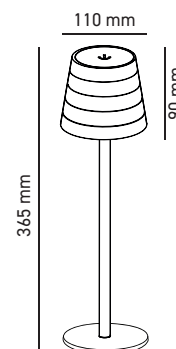





Ricaricabile / Rechargeable USB-C



- Lampada da tavolo a batteria ricaricabile IP54
- Paralume dal design minimalista geometrico a gradini
- Corpo in alluminio e diffusore in policarbonato
- Completa di cavo di alimentazione USB-C da 1m (alimentatore non incluso)
- Superficie touch di accensione e regolazione della luce
- Batteria al litio
- Tempo di ricarica 10/12 ore
- Tempo di funzionamento da 9 a 48 ore (a seconda della dimmerazione)

- IP54 rechargeable battery table lamp
- Lampshade with minimalist stepped geometric design
- Aluminum body and polycarbonate diffuser
- Supplied with 1m USB-C power cable (power adapter not included)
- Touch surface for power on and light adjustment
- Lithium battery
- Charging time 10/12 hours
- Operating time from 9 to 48 hours (depending on dimming)



W	K	LUMEN APPARECCHIO lm	VARIANTE	CODICE	EAN	
3	 3000	250	<input type="checkbox"/> BIANCA / WHITE	<b>MAYA-B</b>	8031453028343	1/8
3	 3000	250	<input checked="" type="checkbox"/> NERO / BLACK	<b>MAYA-N</b>	8031453028350	1/8
3	 3000	250	<input checked="" type="checkbox"/> CORTEN	<b>MAYA-C</b>	8031453028367	1/8
Cavo di ricarica USB-A - USB-C 1m / USB-A - USB-C charging cable 1m				<b>CABLETL</b>	8031453032340	1
HUB di ricarica USB - 10 porte - 50W/ USB charging HUB - 10 ports - 50W				<b>HUBTL50</b>	8031453033033	1



HUB di ricarica USB - 10 porte - 50W/  
USB charging HUB - 10 ports - 50W  
**HUBTL50**



**MAYA**

# TAG

Lampada da tavolo ricaricabile / Rechargeable table lamp



- Lampada da tavolo a batteria ricaricabile IP54
- Corpo in alluminio e diffusore in policarbonato trasparente
- Completa di base di ricarica con cavo di alimentazione USB da 1 m (alimentatore non incluso)
- Superficie touch di accensione e regolazione della luce
- Batteria al litio
- Tempo di ricarica 4 ore
- Tempo di funzionamento da 4 a 25 ore (a seconda della dimmerazione)

- IP54 rechargeable battery table lamp
- Aluminum body and transparent polycarbonate diffuser
- Supplied with 1m USB cabled charging base (power adapter not included)
- Touch surface for power on and light adjustment
- Lithium battery
- Charging time 4 hours
- Operating time from 4 to 25 hours (depending on dimming)



W	K	LUMEN APPARECCHIO lm	VARIANTE	CODICE	EAN	
3		3000	250  CARTA DA ZUCCHERO / PASTEL BLUE	<b>TAG-A</b>	8031453031060	1/16
3		3000	250  BIANCO / TRAFFIC WHITE	<b>TAG-B</b>	8031453031046	1/16
3		3000	250  CORTEN	<b>TAG-C</b>	8031453031053	1/16
3		3000	250  AVORIO / LIGHT IVORY	<b>TAG-I</b>	8031453031077	1/16
3		3000	250  NERO / TRAFFIC BLACK	<b>TAG-N</b>	8031453031039	1/16
3		3000	250  BLU PETROLIO / OCEAN BLUE	<b>TAG-P</b>	8031453031084	1/16
3		3000	250  ROSSO LAMPONE / RASPBERRY RED	<b>TAG-R</b>	8031453031091	1/16
3		3000	250  VERDE SALVIA / PALE GREEN	<b>TAG-V</b>	8031453031107	1/16
Base di ricarica per lampada da tavolo / Charging base for table lamp				<b>TAGCB</b>	8031453032388	1
HUB di ricarica USB - 10 porte - 50W/ USB charging HUB - 10 ports - 50W				<b>HUBTL50</b>	8031453033033	1



HUB di ricarica USB - 10 porte - 50W/  
USB charging HUB - 10 ports - 50W

**HUBTL50**



**TAG**

# MAGNETIKA

BTL CATEGORIA SCONTO 23

Lampada da tavolo ricaricabile multifunzione / Multifunction rechargeable table lamp

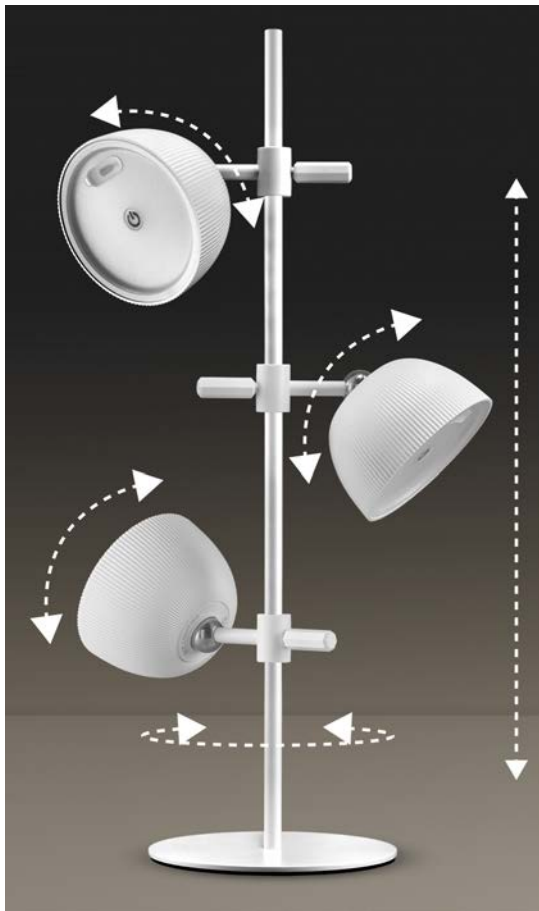

Pinza clip on  
Clip on lamp



Innesto magnetico  
Magnetic coupling



Piastra di fissaggio da parete  
(biadesivo incluso)  
Wall fixing plate  
(double sided tape included)

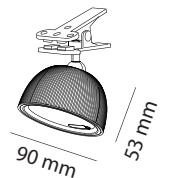
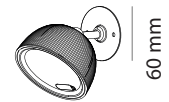
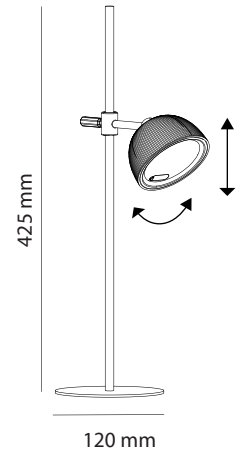

- Lampada da tavolo a batteria ricaricabile IP54
- Design moderno e minimalista adatto ad ogni ambiente
- Struttura in metallo, corpo e diffusore in policarbonato
- Completa di cavo di alimentazione USB-C da 1m (alimentatore non incluso)
- Accensione, spegnimento e regolazione tramite il tocco del diffusore
- Batteria al litio
- Tempo di ricarica 4-6 ore
- Tempo di funzionamento da 6 a 20 ore (a seconda della dimmerazione)
- In dotazione 2 accessori per installazione: clip e piastra di fissaggio

- IP54 rechargeable battery table lamp
- Modern and minimalist design suitable for any environment
- Metal structure, polycarbonate body and diffuser
- Supplied with 1m USB-C power cable (power adapter not included)
- On, off and dimming by touching the diffuser
- Lithium battery
- Charging time 4-6 hours
- Operating time from 6 to 20 hours (depending on dimming and environmental conditions)
- Supplied with 2 installation accessories: clip and fixing plate



W	K	LUMEN APPARECCHIO lm	VARIANTE	CODICE	EAN	
3	3000	200	<input type="checkbox"/> BIANCO / WHITE	<b>MAGNETIKAB</b>	8031453030315	1/12
3	3000	200	<input checked="" type="checkbox"/> NERO / BLACK	<b>MAGNETIKAN</b>	8031453030322	1/12
3	3000	200	<input type="checkbox"/> SILVER	<b>MAGNETIKAS</b>	8031453030339	1/12
Cavo di ricarica USB-A - USB-C 1m / USB-A - USB-C charging cable 1m				<b>CABLETL</b>	8031453032340	1
HUB di ricarica USB - 10 porte - 50W/ USB charging HUB - 10 ports - 50W				<b>HUBTL50</b>	8031453033033	1



HUB di ricarica USB - 10 porte - 50W/  
USB charging HUB - 10 ports - 50W  
**HUBTL50**



**MAGNETIKA**

# TIZIA

BTL CATEGORIA SCONTO 23

Lampada da tavolo ricaricabile solare / Rechargeable table and solar lamp

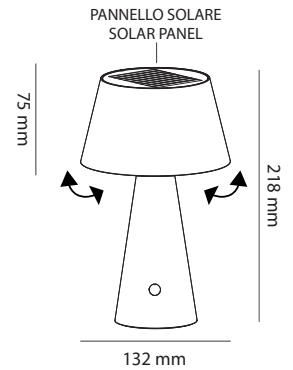











Varie modalità di funzionamento programmabili tramite il tasto di accensione

*Different operation modes programmable via the power button*

- \_ Lampada da tavolo IP54 a ricarica solare e USB-C
- \_ Corpo in ABS e diffusore in PS
- \_ Pannello solare monocristallino da 0,5Wp
- \_ Paralume orientabile
- \_ Batteria al litio
- \_ Tempo di ricarica 4 ore, tramite cavo USB C (non incluso)
- \_ Tempo di funzionamento da 2 a 8 ore (a seconda della dimmerazione)

- \_ IP54 rechargeable solar and USB-C table lamp
- \_ ABS body and PS diffuser
- \_ 0,5Wp monocrystallin solar panel
- \_ Adjustable lampshade
- \_ Lithium battery
- \_ Charging time 4 hours, via USB C cable (not included)
- \_ Operating time from 2 to 8 hours (depending on dimming)



W	K	LUMEN APPARECCHIO lm	VARIANTE	CODICE	EAN	
2.6	 3000	500	 BLU / BLUE	<b>TIZIA-B</b>	8031453031121	1/18
2.6	 3000	500	 NERO / TRAFFIC BLACK	<b>TIZIA-N</b>	8031453031312	1/18
2.6	 3000	500	 ROSSO / RED	<b>TIZIA-R</b>	8031453031114	1/18
2.6	 3000	500	 VERDE / GREEN	<b>TIZIA-V</b>	8031453031138	1/18
2.6	 3000	500	 BIANCO / TRAFFIC WHITE	<b>TIZIA-W</b>	8031453031145	1/18
Cavo di ricarica USB-A - USB-C 1m / USB-A - USB-C charging cable 1m				<b>CABLETL</b>	8031453032340	1
HUB di ricarica USB - 10 porte - 50W/ USB charging HUB - 10 ports - 50W				<b>HUBTL50</b>	8031453033033	1



HUB di ricarica USB - 10 porte - 50W/  
USB charging HUB - 10 ports - 50W  
**HUBTL50**



**TIZIA**



**SHOT**  
BOT LIGHTING

**RESIDENZIALE / LAMPADE OUTDOOR**  
RESIDENTIAL / OUTDOOR LAMPS

# ALICANTE

BTL CATEGORIA SCONTO 24

Applique / Wall lamp

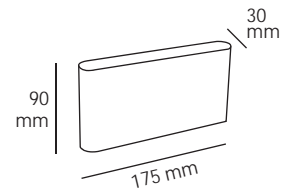

Fascio doppio  
Double beam

- \_ Applique da parete in alluminio per interni ed esterni
- \_ Corpo in alluminio pressofuso verniciato
- \_ Moduli LED integrati 2X5W (doppia emissione)
- \_ CCT selezionabile

- \_ Aluminum wall light for indoors and outdoors
- \_ Painted die-cast aluminium body
- \_ Built-in LED modules 2X5W (up and down)
- \_ Selectable CCT



W	K	LUMEN APPARECCHIO lm	LUMEN SORGENTE lm		VARIANTE	CODICE	EAN		
10	<input type="checkbox"/> 3000 <input type="checkbox"/> 4000 <input type="checkbox"/> 5500	580	820	2X150°	<input type="checkbox"/> BIANCO / WHITE	<b>ALICANTE10B</b>	8031453022013	1/20	
10	<input type="checkbox"/> 3000 <input type="checkbox"/> 4000 <input type="checkbox"/> 5500	500	820	2X150°	<input checked="" type="checkbox"/> ANTRACITE / ANTHRACITE	<b>ALICANTE10G</b>	8031453022020	1/20	



**ALICANTE**

# MADRID 7

BTL CATEGORIA SCONTO 24

Applique / Wall lamp

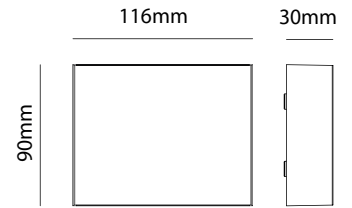

Fascio doppio  
Double beam

- \_ Applique da parete per interni ed esterni
- \_ Corpo in alluminio pressofuso verniciato
- \_ Moduli LED integrati 2x3,5W (doppia emissione)
- \_ CCT selezionabile

- \_ Interior and exterior wall light in aluminium
- \_ Painted die-cast aluminum body
- \_ Built-in 2x3,5W LED module (up and down)
- \_ Selectable CCT



W	K	LUMEN APPARECCHIO lm	LUMEN SORGENTE lm		VARIANTE	CODICE	EAN		
7	<input type="checkbox"/> 3000 <input type="checkbox"/> 4000 <input type="checkbox"/> 5000	510	740	2x90°	<input type="checkbox"/> BIANCO / WHITE	<b>MADRID7BK</b>	8031453030636	1/20	
7	<input type="checkbox"/> 3000 <input type="checkbox"/> 4000 <input type="checkbox"/> 5000	490	740	2x90°	<input checked="" type="checkbox"/> ANTRACITE / ANTHRACITE	<b>MADRID7GK</b>	8031453030643	1/20	
7	<input type="checkbox"/> 3000 <input type="checkbox"/> 4000 <input type="checkbox"/> 5000	490	740	2x90°	<input checked="" type="checkbox"/> CORTEN	<b>MADRID7CK</b>	8031453030650	1/20	



**MADRID 7**

# MADRID 24

BTL CATEGORIA SCONTO 24

Applique / Wall lamp

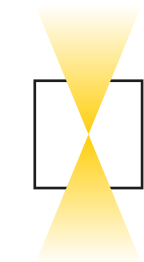
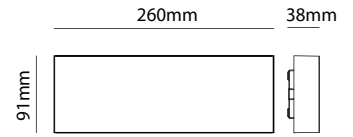

Fascio doppio  
Double beam

- \_ Applique da parete in alluminio per interni ed esterni
- \_ Corpo in alluminio pressofuso verniciato
- \_ Moduli LED integrati 2x12W (doppia emissione)
- \_ CCT selezionabile

- \_ Interior and exterior wall light in aluminium
- \_ Painted die-cast aluminum body
- \_ Built-in LED 2x12W (up and down)
- \_ Selectable CCT



W	K	LUMEN APPARECCHIO lm	LUMEN SORGENTE lm		VARIANTE	CODICE	EAN		
24	<input type="checkbox"/> 3000 <input type="checkbox"/> 4000 <input type="checkbox"/> 5000	1690	2900	2x90°	<input type="checkbox"/> BIANCO / WHITE	<b>MADRID24BK</b>	8031453030667	1/10	
24	<input type="checkbox"/> 3000 <input type="checkbox"/> 4000 <input type="checkbox"/> 5000	1610	2900	2x90°	<input checked="" type="checkbox"/> ANTRACITE / ANTHRACITE	<b>MADRID24GK</b>	8031453030674	1/10	
24	<input type="checkbox"/> 3000 <input type="checkbox"/> 4000 <input type="checkbox"/> 5000	1600	2900	2x90°	<input checked="" type="checkbox"/> CORTEN	<b>MADRID24CK</b>	8031453030681	1/10	



**MADRID 24**

# NIVES1

BTL CATEGORIA SCONTO 24

Applique singola emissione / Single emission wall lamp

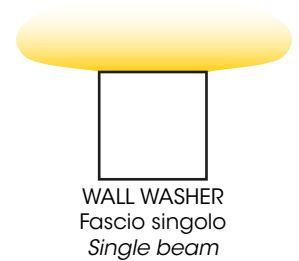
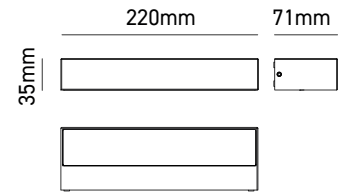

Applique da parete in alluminio con effetto wall washer, perfetta per creare un'illuminazione scenografica. Il suo design elegante è ideale per ambienti sia interni che esterni. La soluzione perfetta per un'illuminazione funzionale e stilisticamente raffinata.

Wall-mounted aluminum light fixture with a wall washer effect, perfect for creating dramatic lighting. Its elegant design makes it ideal for both indoor and outdoor spaces. The perfect solution for functional and stylishly refined lighting

- Applique da parete con corpo in alluminio e diffusore in vetro per interni ed esterni
- Modulo LED integrato da 12W
- Fascio singolo effetto wall washer
- CCT selezionabile

- Aluminum body and glass diffuser wall light for indoor and outdoor use
- Integrated 12W LED module
- Single beam with wall washer effect
- Selectable CCT



W	K	LUMEN APPARECCHIO lm	LUMEN SORGENTE lm		VARIANTE	CODICE	EAN		
12	<input type="checkbox"/> 3000 <input type="checkbox"/> 4000 <input type="checkbox"/> 5000	1000	1600	85°	<input type="checkbox"/> BIANCO / WHITE	<b>NIVES112BK</b>	8031453032456	1/20	
12	<input type="checkbox"/> 3000 <input type="checkbox"/> 4000 <input type="checkbox"/> 5000	950	1600	85°	<input checked="" type="checkbox"/> ANTRACITE / ANTHRACITE	<b>NIVES112GK</b>	8031453032470	1/20	
12	<input type="checkbox"/> 3000 <input type="checkbox"/> 4000 <input type="checkbox"/> 5000	950	1600	85°	<input checked="" type="checkbox"/> CORTEN	<b>NIVES112CK</b>	8031453032463	1/20	



**NIVES 1**

# NIVES2

BTL CATEGORIA SCONTO 24

Applique doppia emissione / Double emission wall lamp

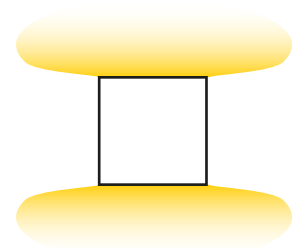
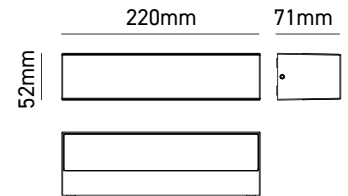

WALL WASHER  
Fascio doppio  
Double beam

Applique da parete in alluminio con effetto wall washer, perfetta per creare un'illuminazione scenografica. Il suo design elegante è ideale per ambienti sia interni che esterni. La soluzione perfetta per un'illuminazione funzionale e stilisticamente raffinata

Wall-mounted aluminum light fixture with a wall washer effect, perfect for creating dramatic lighting. Its elegant design makes it ideal for both indoor and outdoor spaces. The perfect solution for functional and stylishly refined lighting

- Applique da parete con corpo in alluminio e diffusore in vetro per interni ed esterni
- Moduli LED integrati 2x10W (doppia emissione)
- Doppia emissione effetto wall washer
- CCT selezionabile

- Aluminum body and glass diffuser wall light for indoor and outdoor use
- Integrated LED modules 2x10W
- Dual emission with wall washer effect
- Selectable CCT



W	K	LUMEN APPARECCHIO lm	LUMEN SORGENTE lm		VARIANTE	CODICE	EAN		
20	<input type="checkbox"/> 3000 <input type="checkbox"/> 4000 <input type="checkbox"/> 5000	1700	2600	2x85°	<input type="checkbox"/> BIANCO / WHITE	<b>NIVES220BK</b>	8031453032487	1/20	
20	<input type="checkbox"/> 3000 <input type="checkbox"/> 4000 <input type="checkbox"/> 5000	1550	2600	2x85°	<input checked="" type="checkbox"/> ANTRACITE / ANTHRACITE	<b>NIVES220GK</b>	8031453032500	1/20	
20	<input type="checkbox"/> 3000 <input type="checkbox"/> 4000 <input type="checkbox"/> 5000	1600	2600	2x85°	<input checked="" type="checkbox"/> CORTEN	<b>NIVES220CK</b>	8031453032494	1/20	



**NIVES 2**

# LUNA

Applique / Wall lamp

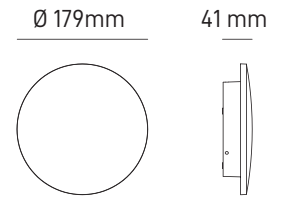

- Applique da parete rotonda in alluminio
- Modulo LED integrato da 9W - 1000lm
- Illuminazione posteriore indiretta
- Verniciatura a polveri resistente ai raggi UV

- Round aluminum wall light
- Integrated 9W - 1000lm LED module
- Indirect rear lighting
- UV-resistant powder coating



W	K	LUMEN APPARECCHIO lm	LUMEN SORGENTE lm		VARIANTE	CODICE	EAN		
9	<input type="checkbox"/> 3000 <input type="checkbox"/> 4000 <input type="checkbox"/> 5200	870	1000	75°	<input type="checkbox"/> BIANCO / WHITE	<b>LUNA9B</b>	8031453027469	1/12	
9	<input type="checkbox"/> 3000 <input type="checkbox"/> 4000 <input type="checkbox"/> 5200	630	1000	75°	<input checked="" type="checkbox"/> ANTRACITE / ANTHRACITE	<b>LUNA9G</b>	8031453027476	1/12	



**LUNA**

# NORAMINI

BTL CATEGORIA SCONTO 24

Applique / Wall lamp



NORAMINI S: 100mm 68mm

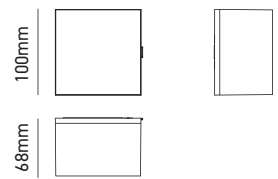

NORAMINI M: 200mm

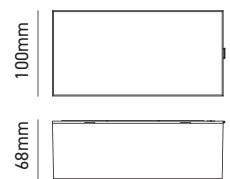

NORAMINI L: 300mm

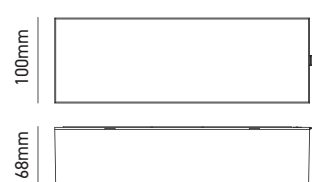

- Applique in policarbonato, IP65, ideale sia per esterni che per interni
- Disponibile in tre misure e due forme differenti
- Potenza e CCT selezionabili

- Polycarbonate wall light, IP65 rated, ideal for both outdoor and indoor use
- Available in three sizes and two different shapes
- Power and CCT selectable



W	K	LUMEN APPARECCHIO lm	LUMEN SORGENTE lm		VARIANTE	CODICE	EAN			
2		3000	200	300	SMALL	NORAMINIS	8031453034610	1/20		
3		4000	300	400						150°
4		6000	400	500						
4		3000	350	500	MEDIUM	NORAMINIM	8031453034627	1/10		
6		4000	500	700						150°
8		6000	700	950						
8		3000	650	900	LARGE	NORAMINIL	8031453034634	1/10		
10		4000	800	1150						150°
12		6000	1000	1400						



**NORA MINI**

# MARBELLA SQUARED

BTL CATEGORIA SCONTO 24

Applique / Wall lamp

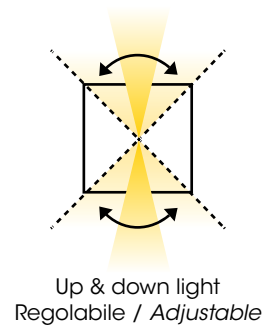
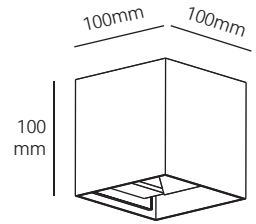

- Applique da parete in alluminio per interni ed esterni
- Moduli LED integrati 2x5W (doppia emissione)
- Doppio fascio regolabile 0° - 90° senza l'uso di attrezzi
- CCT selezionabile

- Interior and exterior wall light in aluminium
- Built-in LED modules 2x5W (up and down)
- Double light beam adjustable individually 0°-90° no tools needed
- Selectable CCT



W	K	LUMEN APPARECCHIO lm	LUMEN SORGENTE lm		VARIANTE	CODICE	EAN		
10	<input type="checkbox"/> 3000 <input type="checkbox"/> 4000 <input type="checkbox"/> 5500	590	610	2x90°	<input type="checkbox"/> BIANCO / WHITE	<b>MARBELLA10BQK</b>	8031453024994	1/20	
10	<input type="checkbox"/> 3000 <input type="checkbox"/> 4000 <input type="checkbox"/> 5500	480	610	2x90°	<input checked="" type="checkbox"/> ANTRACITE / ANTHRACITE	<b>MARBELLA10GQK</b>	8031453025007	1/20	
10	<input type="checkbox"/> 3000 <input type="checkbox"/> 4000 <input type="checkbox"/> 5500	520	610	2x90°	<input checked="" type="checkbox"/> GRIGIO MARINA / LIGHT GREY	<b>MARBELLA10MQK</b>	8031453025014	1/20	
10	<input type="checkbox"/> 3000 <input type="checkbox"/> 4000 <input type="checkbox"/> 5500	480	610	2x90°	<input checked="" type="checkbox"/> CORTEN	<b>MARBELLA10CQK</b>	8031453025021	1/20	
10	<input type="checkbox"/> 3000 <input type="checkbox"/> 4000 <input type="checkbox"/> 5500	480	610	2x90°	<input checked="" type="checkbox"/> NERO / BLACK	<b>MARBELLA10NQK</b>	8031453033774	1/20	

# MARBELLA ROUND

BTL CATEGORIA SCONTO 24

Applique / Wall lamp

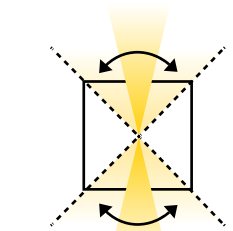
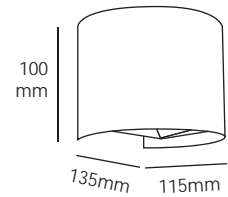

Up & down light  
Regolabile / Adjustable

- \_ Applique da parete in alluminio per interni ed esterni
- \_ Moduli LED integrati 2x5W (doppia emissione)
- \_ Doppio fascio regolabile 0° - 90° senza l'uso di attrezzi
- \_ CCT selezionabile

- \_ Interior and exterior wall light in aluminium
- \_ Built-in LED modules 2x5W (up and down)
- \_ Double light beam adjustable individually 0°-90° no tools needed
- \_ Selectable CCT



W	K	LUMEN APPARECCHIO lm	LUMEN SORGENTE lm		VARIANTE	CODICE	EAN		
10	<input type="checkbox"/> 3000 <input type="checkbox"/> 4000 <input type="checkbox"/> 5500	590	610	2x90°	<input type="checkbox"/> BIANCO / WHITE	<b>MARBELLA10BRK</b>	8031453024963	1/20	
10	<input type="checkbox"/> 3000 <input type="checkbox"/> 4000 <input type="checkbox"/> 5500	480	610	2x90°	<input checked="" type="checkbox"/> ANTRACITE / ANTHRACITE	<b>MARBELLA10GRK</b>	8031453024970	1/20	
10	<input type="checkbox"/> 3000 <input type="checkbox"/> 4000 <input type="checkbox"/> 5500	480	610	2x90°	<input checked="" type="checkbox"/> CORTEN	<b>MARBELLA10CRK</b>	8031453025038	1/20	

# MARBELLA BIG SQUARED

BTL CATEGORIA SCONTO 24

Applique / Wall lamp

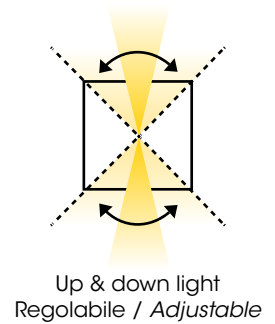
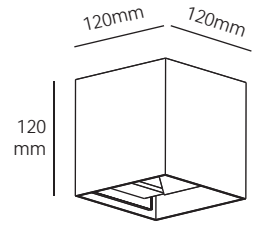

- \_ Applique da parete in alluminio per interni ed esterni
- \_ Moduli LED integrati 2x10W (doppia emissione)
- \_ Doppio fascio regolabile 0° - 90° senza l'uso di attrezzi
- \_ CCT selezionabile

- \_ Interior and exterior wall light in aluminium
- \_ Built-in LED modules 2x10W (up and down)
- \_ Double light beam adjustable individually 0°-90° no tools needed
- \_ Selectable CCT



W	K	LUMEN APPARECCHIO lm	LUMEN SORGENTE lm		VARIANTE	CODICE	EAN		
20	<input type="checkbox"/> 3000 <input type="checkbox"/> 4000 <input type="checkbox"/> 5500	1180	1220	2x90°	<input type="checkbox"/> BIANCO / WHITE	MARBELLA20BQK	8031453025878	1/10	
20	<input type="checkbox"/> 3000 <input type="checkbox"/> 4000 <input type="checkbox"/> 5500	960	1220	2x90°	<input checked="" type="checkbox"/> ANTRACITE / ANTHRACITE	MARBELLA20GQK	8031453025861	1/10	
20	<input type="checkbox"/> 3000 <input type="checkbox"/> 4000 <input type="checkbox"/> 5500	1040	1220	2x90°	<input checked="" type="checkbox"/> GRIGIO MARINA / LIGHT GREY	MARBELLA20MQK	8031453025885	1/10	
20	<input type="checkbox"/> 3000 <input type="checkbox"/> 4000 <input type="checkbox"/> 5500	960	1220	2x90°	<input checked="" type="checkbox"/> CORTEN	MARBELLA20CQK	8031453025892	1/10	



**MARBELLA BIG**

# MARBELLA DUO

BTL CATEGORIA SCONTO 24

Applique / Wall lamp

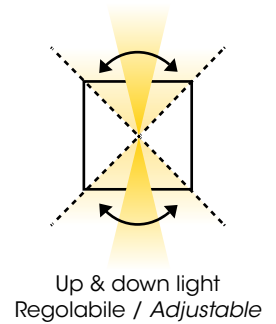
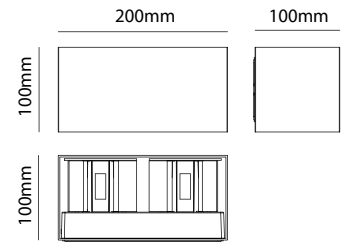
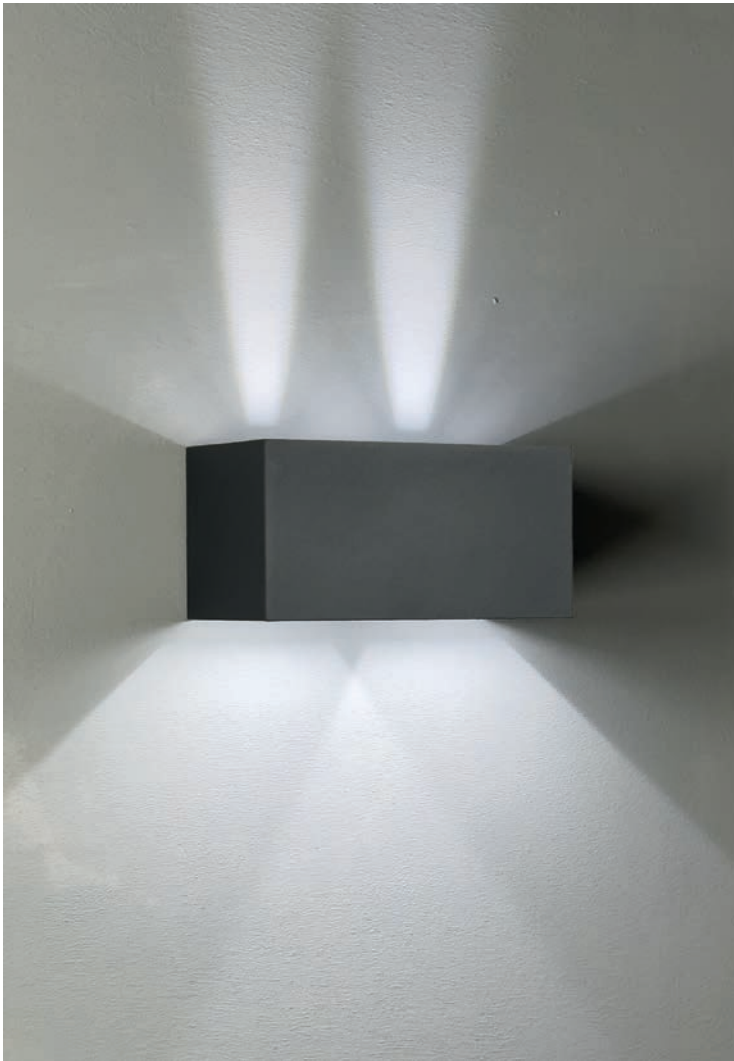

- \_ Applique da parete in alluminio per interni ed esterni
- \_ Moduli LED integrati 4x5W (quadrupla emissione)
- \_ Quattro fasci regolabili separatamente 0° - 85° senza l'uso di attrezzi
- \_ CCT selezionabile

- \_ Aluminum wall light for indoors and outdoors
- \_ Built-in LED modules 4x5W (quadruple emission)
- \_ Four lights beam adjustable individually 0°-85° no tools needed
- \_ Selectable CCT



W	K	LUMEN APPARECCHIO lm	LUMEN SORGENTE lm		VARIANTE	CODICE	EAN		
20	<input type="checkbox"/> 3000 <input type="checkbox"/> 4000 <input type="checkbox"/> 6500	1085	2040	4x85°	<input type="checkbox"/> BIANCO / WHITE	MARBELLADUO20BK	8031453030605	1/10	
20	<input type="checkbox"/> 3000 <input type="checkbox"/> 4000 <input type="checkbox"/> 6500	810	2040	4x85°	<input checked="" type="checkbox"/> ANTRACITE / ANTHRACITE	MARBELLADUO20GK	8031453030612	1/10	
20	<input type="checkbox"/> 3000 <input type="checkbox"/> 4000 <input type="checkbox"/> 6500	805	2040	4x85°	<input checked="" type="checkbox"/> CORTEN	MARBELLADUO20CK	8031453030629	1/10	



**MARBELLA DUO**

# MALAGA

BTL CATEGORIA SCONTO 24

Plafone / Ceiling lamp

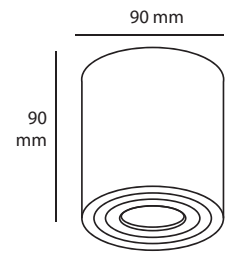

GU10 ALTA  
TEMPERATURA  
P. 98

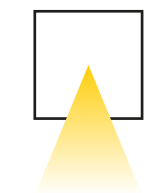







Fascio singolo  
Single beam

\_ Plafoniera in alluminio con schermo in vetro per interni ed esterni  
\_ Attacco GU10 per sorgenti LED max 7W (modello suggerito GU10 alta temperatura)

\_ Interior and exterior ceiling light in aluminium with glass diffuser  
\_ GU10 base for LED light sources max 7W (suggested model high temperature GU10)



W	BASE		VARIANTE	CODICE	EAN	
-	GU10	-	 BIANCO / WHITE	<b>MALAGAB</b>	8031453025076	1/20
-	GU10	-	 ANTRACITE / ANTHRACITE	<b>MALAGAG</b>	8031453025090	1/20
-	GU10	-	 GRIGIO MARINA / LIGHT GREY	<b>MALAGAM</b>	8031453025106	1/20
-	GU10	-	 CORTEN	<b>MALAGAC</b>	8031453025083	1/20
-	GU10	-	 NERO / BLACK	<b>MALAGAN</b>	8031453033798	1/20

# ALMERIA

BTL CATEGORIA SCONTO 24

Plafone / Ceiling lamp

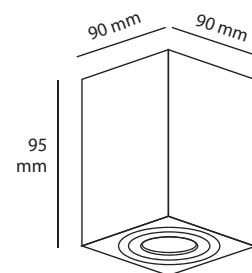

GU10 ALTA  
TEMPERATURA  
P. 98









Fascio singolo  
Single beam

\_ Plafoniera in alluminio con schermo in vetro per interni ed esterni  
\_ Attacco GU10 per sorgenti LED max 7W (modello suggerito GU10 alta temperatura)

\_ Interior and exterior ceiling light in aluminium with glass diffuser  
\_ GU10 base for LED light sources max 7W (suggested model high temperature GU10)



W	BASE		VARIANTE	CODICE	EAN	
-	GU10	-	 BIANCO / WHITE	<b>ALMERIAB</b>	8031453025113	1/20
-	GU10	-	 ANTRACITE / ANTHRACITE	<b>ALMERIAG</b>	8031453025137	1/20
-	GU10	-	 GRIGIO MARINA / LIGHT GREY	<b>ALMERIAM</b>	8031453025144	1/20
-	GU10	-	 CORTEN	<b>ALMERIAC</b>	8031453025120	1/20
-	GU10	-	 NERO / BLACK	<b>ALMERIAN</b>	8031453033781	1/20

# TOLEDO 1

BTL CATEGORIA SCONTO 24

Applique singola emissione / Single emission wall lamp

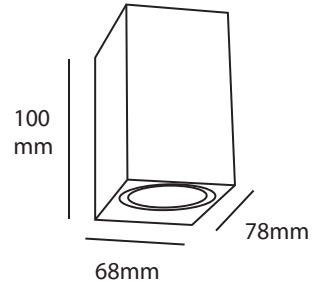

GU10 ALTA  
TEMPERATURA  
P. 98

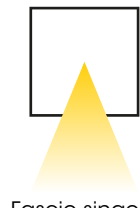

Fascio singolo  
Single beam

- \_ Applique da parete in alluminio con schermo in vetro per interni ed esterni
- \_ Attacco GU10 per sorgenti LED max 7W (modello suggerito GU10 alta temperatura)

- \_ Interior and exterior wall light in aluminium with glass diffuser
- \_ GU10 base for LED light sources max 7W (suggested model high temperature GU10)



W	BASE		VARIANTE	CODICE	EAN	
-	GU10	-	BIANCO / WHITE	<b>TOLEDO1B</b>	8031453023829	1/40
-	GU10	-	ANTRACITE / ANTHRACITE	<b>TOLEDO1G</b>	8031453023843	1/40
-	GU10	-	GRIGIO MARINA / LIGHT GREY	<b>TOLEDO1M</b>	8031453023850	1/40
-	GU10	-	CORTEN	<b>TOLEDO1C</b>	8031453023836	1/40
-	GU10	-	NERO / BLACK	<b>TOLEDO1N</b>	8031453033804	1/40

# TOLEDO 2

BTL CATEGORIA SCONTO 24

Applique doppia emissione / Double emission wall lamp

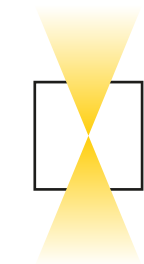
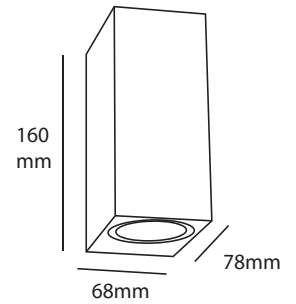







Fascio doppio  
Double beam

- Applique da parete in alluminio con schermo in vetro per interni ed esterni
- Attacco GU10 per sorgenti LED max 2x7W (modello suggerito GU10 alta temperatura)

- Interior and exterior wall light in aluminium with glass diffuser
- GU10 base for LED light sources max 2x7W (suggested model high temperature GU10)



W	BASE		VARIANTE	CODICE	EAN	
-	GU10	-	 BIANCO / WHITE	<b>TOLEDO2B</b>	8031453023867	1/20
-	GU10	-	 ANTRACITE / ANTHRACITE	<b>TOLEDO2G</b>	8031453023881	1/20
-	GU10	-	 GRIGIO MARINA / LIGHT GREY	<b>TOLEDO2M</b>	8031453023898	1/20
-	GU10	-	 CORTEN	<b>TOLEDO2C</b>	8031453023874	1/20
-	GU10	-	 NERO / BLACK	<b>TOLEDO2N</b>	8031453033811	1/20

# TOLEDO 10

BTL CATEGORIA SCONTO 24

Applique / Wall lamp

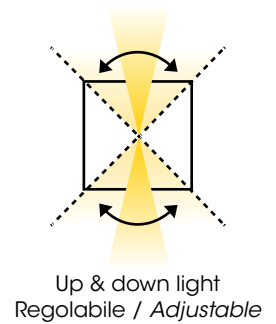
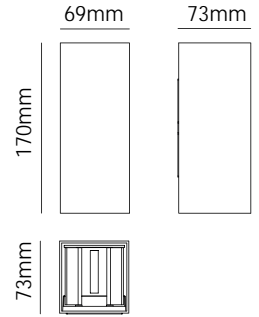

- \_ Applique da parete in alluminio per interni ed esterni
- \_ Moduli LED integrati 2x5W (doppia emissione)
- \_ Doppio fascio regolabile 0° - 70° senza l'uso di attrezzi
- \_ Scala graduata per regolazione dell'ampiezza del fascio
- \_ CCT selezionabile

- \_ Interior and exterior wall light in aluminium
- \_ Built-in LED 2x5W (up and down)
- \_ Double light beam adjustable individually 0°-70° no tools needed
- \_ Graduated scale to adjust the beam width
- \_ Selectable CCT



W	K	LUMEN APPARECCHIO lm	LUMEN SORGENTE lm		VARIANTE	CODICE	EAN		
10	<input type="checkbox"/> 3000 <input type="checkbox"/> 4000 <input type="checkbox"/> 6500	480	1020	2x70°	<input type="checkbox"/> BIANCO / WHITE	TOLEDO10BK	8031453030698	1/10	
10	<input type="checkbox"/> 3000 <input type="checkbox"/> 4000 <input type="checkbox"/> 6500	350	1020	2x70°	<input checked="" type="checkbox"/> ANTRACITE / ANTHRACITE	TOLEDO10GK	8031453030704	1/10	
10	<input type="checkbox"/> 3000 <input type="checkbox"/> 4000 <input type="checkbox"/> 6500	345	1020	2x70°	<input checked="" type="checkbox"/> CORTEN	TOLEDO10CK	8031453030711	1/10	

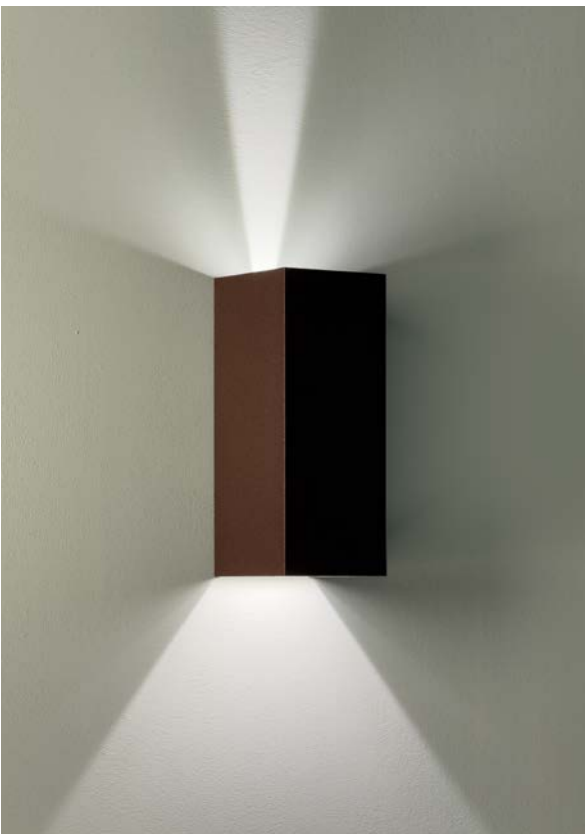

**TOLEDO 10**

# MURCIA 1 NEW

BTL CATEGORIA SCONTO 24

Applique singola emissione / Single emission wall lamp

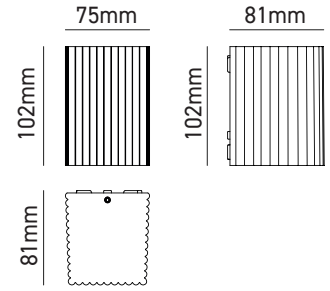

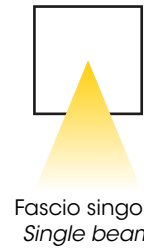

GU10 ALTA  
TEMPERATURA  
P. 98



- Applique da parete in alluminio con diffusore in vetro per interni ed esterni
- Design plissettato ed esclusive tonalità pastello
- Attacco GU10 per sorgenti LED max 7W (modello suggerito GU10 alta temperatura)

- Wall light in aluminum with glass diffuser for indoor and outdoor use
- Pleated design and exclusive pastel shades
- GU10 socket for max 7W LED sources (high-temperature GU10 model suggested)



W	BASE		VARIANTE	CODICE	EAN	
-	GU10	-	<span style="color: #00a0c0;">■</span> CARTA DA ZUCCHERO / PASTEL BLUE	<b>MURCIA1A</b>	8031453035143	1/20
-	GU10	-	<span style="border: 1px solid black; display: inline-block; width: 10px; height: 10px;"></span> BIANCO / WHITE	<b>MURCIA1B</b>	8031453035112	1/20
-	GU10	-	<span style="color: #8b4513;">■</span> CORTEN	<b>MURCIA1C</b>	8031453035129	1/20
-	GU10	-	<span style="color: #c08060;">■</span> TORTORA / TAUPE	<b>MURCIA1T</b>	8031453035167	1/20
-	GU10	-	<span style="color: #333333;">■</span> ANTRACITE / ANTHRACITE	<b>MURCIA1G</b>	8031453035136	1/20
-	GU10	-	<span style="color: #38a83d;">■</span> VERDE SALVIA / PALE GREEN	<b>MURCIA1V</b>	8031453035150	1/20



# MURCIA 2 NEW

BTL CATEGORIA SCONTO 24

Applique doppia emissione / Double emission wall lamp

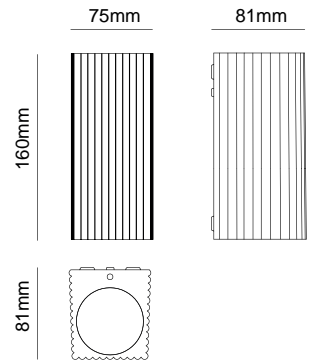

GU10 ALTA  
TEMPERATURA  
P. 98

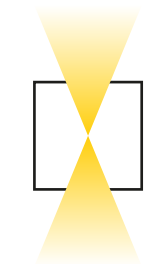



Fascio doppio  
Double beam

- \_ Applique da parete in alluminio con diffusore in vetro per interni ed esterni
- \_ Design plissettato
- \_ Attacco GU10 per sorgenti LED max 2x7W (modello suggerito GU10 alta temperatura)

- \_ Wall light in aluminum with glass diffuser for indoor and outdoor use
- \_ Pleated design
- \_ GU10 socket for max 2x7W LED sources (high-temperature GU10 model suggested)



W	BASE		VARIANTE	CODICE	EAN	
-	GU10	-	<input type="checkbox"/> BIANCO / WHITE	<b>MURCIA2B</b>	8031453035174	1/20
-	GU10	-	<input checked="" type="checkbox"/> CORTEN	<b>MURCIA2C</b>	8031453035181	1/20
-	GU10	-	<input checked="" type="checkbox"/> ANTRACITE / ANTHRACITE	<b>MURCIA2G</b>	8031453035198	1/20

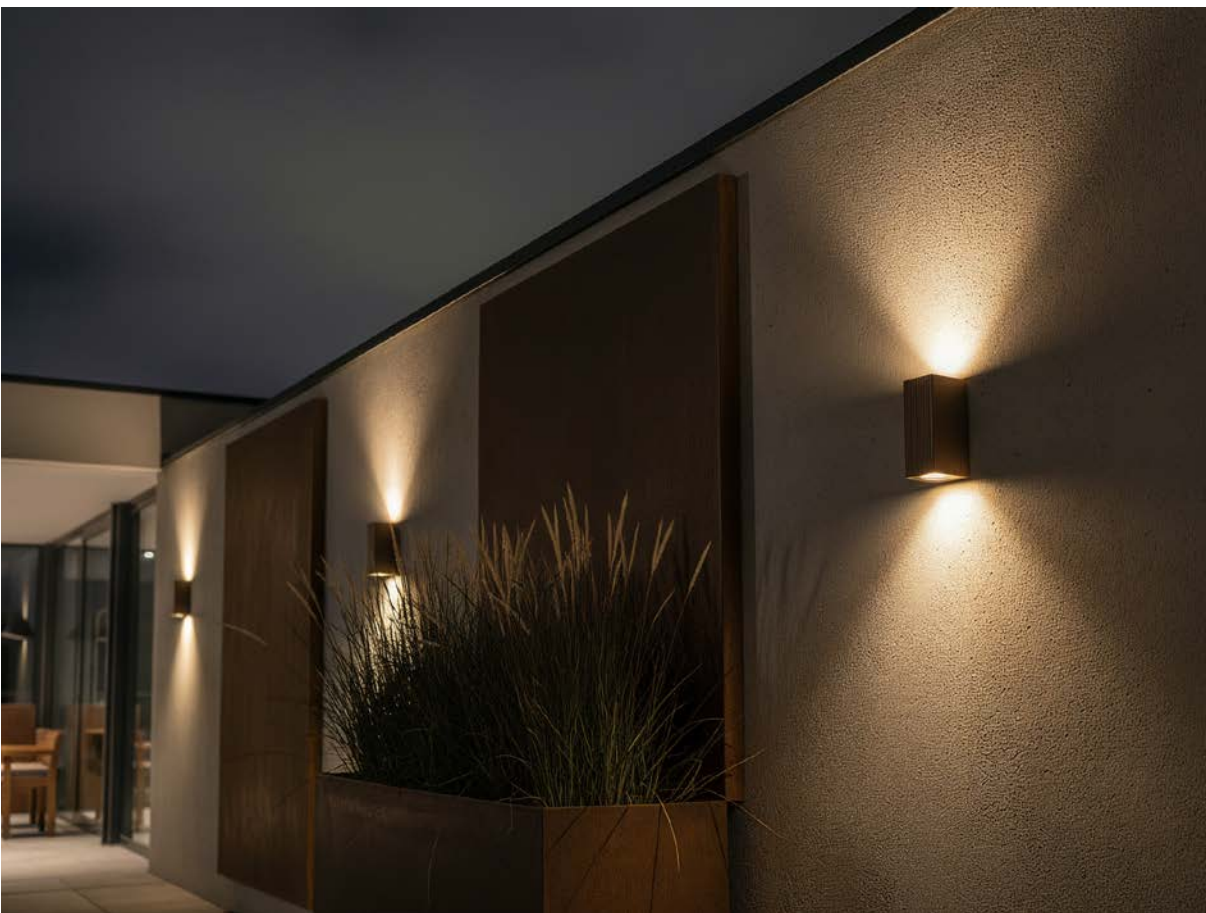

**MURCIA 2**

# SUND

BTL CATEGORIA SCONTO 24

Applique singola emissione / Single emission wall lamp

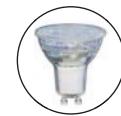
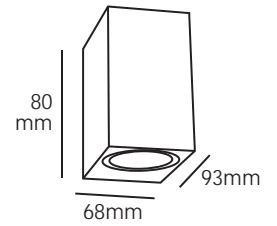

GU10 ALTA  
TEMPERATURA  
P. 98



Fascio singolo  
Single beam

- \_ Applique da parete in alluminio con schermo in vetro per interni ed esterni
- \_ Attacco GU10 per sorgenti LED max 11W (modello suggerito GU10 alta temperatura)

- \_ Interior and exterior wall light in aluminium with glass diffuser
- \_ GU10 base for LED light sources max 11W (suggested model high temperature GU10)



W	BASE		VARIANTE	CODICE	EAN	
-	GU10	-	 BIANCO / WHITE	<b>4118740</b>	6435200226129	1/8
-	GU10	-	 ANTRACITE / ANTHRACITE	<b>4118745</b>	6435200226228	1/8

# SUND DUO

BTL CATEGORIA SCONTO 24

Applique doppia emissione / Double emission wall lamp

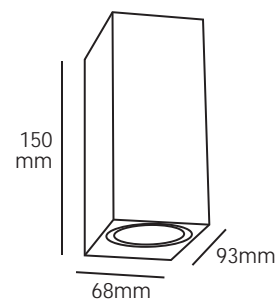
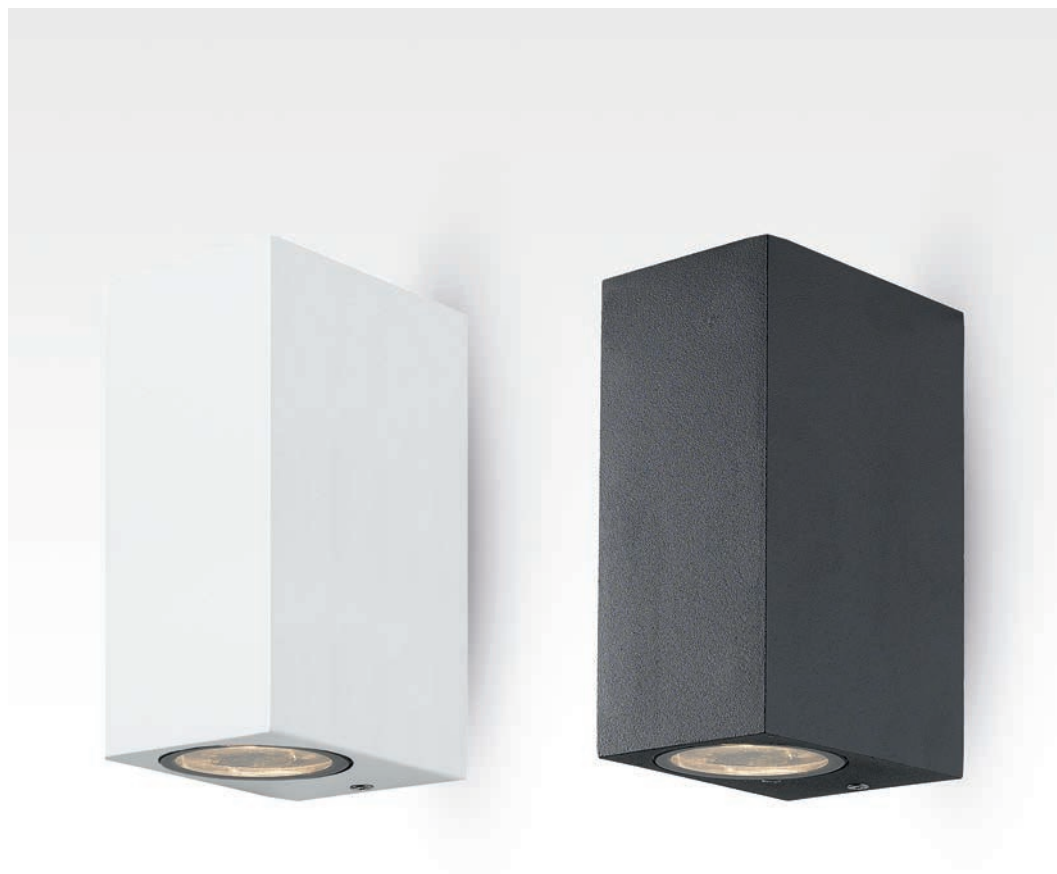

Fascio doppio  
Double beam

- \_ Applique da parete in alluminio con schermo in vetro per interni ed esterni
- \_ Attacco GU10 per sorgenti LED max 2x11W (modello suggerito GU10 alta temperatura)

- \_ Interior and exterior wall light in aluminium with glass diffuser
- \_ GU10 base for LED light sources max 2x11W (suggested model high temperature GU10)



W	BASE		VARIANTE	CODICE	EAN	
-	GU10	-	BIANCO / WHITE	<b>4118742</b>	6435200226167	1/8
-	GU10	-	ANTRACITE / ANTHRACITE	<b>4118746</b>	6435200226242	1/8

# CORDOVA 1

BTL CATEGORIA SCONTO 24

Applique singola emissione / Single emission wall lamp

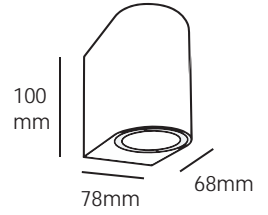

GU10 ALTA  
TEMPERATURA  
P. 98









Fascio singolo  
Single beam

- Applique da parete in alluminio con schermo in vetro per interni ed esterni
- Attacco GU10 per sorgenti LED max 7W (modello suggerito GU10 alta temperatura)

- Interior and exterior wall light in aluminium with glass diffuser
- GU10 base for LED light sources max 7W (suggested model high temperature GU10)



W	BASE		VARIANTE	CODICE	EAN	
-	GU10	-	 BIANCO / WHITE	<b>CORDOVA1B</b>	8031453021849	1/40
-	GU10	-	 ANTRACITE / ANTHRACITE	<b>CORDOVA1G</b>	8031453021856	1/40
-	GU10	-	 GRIGIO MARINA / LIGHT GREY	<b>CORDOVA1M</b>	8031453021863	1/40
-	GU10	-	 CORTEN	<b>CORDOVA1C</b>	8031453023805	1/40

# CORDOVA 2

BTL CATEGORIA SCONTO 24

Applique doppia emissione / Double emission wall lamp

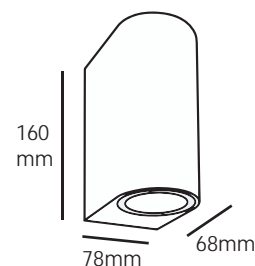







Fascio doppio  
Double beam

- Applique da parete in alluminio con schermo in vetro per interni ed esterni
- Attacco GU10 per sorgenti LED max 2x7W (modello suggerito GU10 alta temperatura)

- Interior and exterior wall light in aluminium with glass diffuser
- GU10 base for LED light sources max 2x7W (suggested model high temperature GU10)



W	BASE		VARIANTE	CODICE	EAN	
-	GU10	-	 BIANCO / WHITE	<b>CORDOVA2B</b>	8031453021870	1/20
-	GU10	-	 ANTRACITE / ANTHRACITE	<b>CORDOVA2G</b>	8031453021887	1/20
-	GU10	-	 GRIGIO MARINA / LIGHT GREY	<b>CORDOVA2M</b>	8031453021894	1/20
-	GU10	-	 CORTEN	<b>CORDOVA2C</b>	8031453023812	1/20

# CORDOVA 10

BTL CATEGORIA SCONTO 24

Applique / Wall lamp

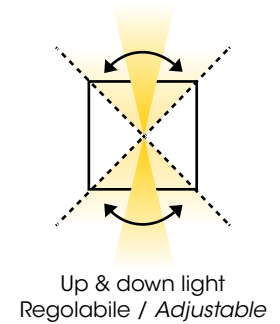
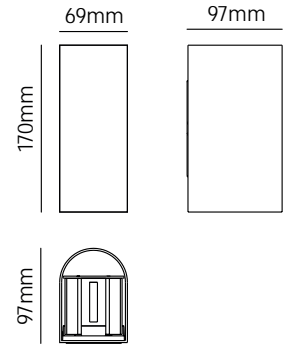

- \_ Applique da parete in alluminio per interni ed esterni
- \_ Moduli LED integrati 2X5W (doppia emissione)
- \_ Doppio fascio regolabile 0° - 70° senza l'uso di attrezzi
- \_ Scala graduata per regolazione dell'ampiezza del fascio
- \_ CCT selezionabile

- \_ Aluminium interior and exterior wall light
- \_ Built-in LED modules 2X5W (double emission)
- \_ Double light beam adjustable individually 0°-70° no tools needed
- \_ Graduated scale to adjust the beam width
- \_ Selectable CCT



W	K	LUMEN APPARECCHIO lm	LUMEN SORGENTE lm		VARIANTE	CODICE	EAN		
10	<input type="checkbox"/> 3000 <input type="checkbox"/> 4000 <input type="checkbox"/> 6500	510	1020	2x70°	<input type="checkbox"/> BIANCO / WHITE	<b>CORDOVA10BK</b>	8031453030728	1/10	
10	<input type="checkbox"/> 3000 <input type="checkbox"/> 4000 <input type="checkbox"/> 6500	360	1020	2x70°	<input checked="" type="checkbox"/> ANTRACITE / ANTHRACITE	<b>CORDOVA10GK</b>	8031453030735	1/10	
10	<input type="checkbox"/> 3000 <input type="checkbox"/> 4000 <input type="checkbox"/> 6500	350	1020	2x70°	<input checked="" type="checkbox"/> CORTEN	<b>CORDOVA10CK</b>	8031453030742	1/10	



**CORDOVA10**

# AVILA

BTL CATEGORIA SCONTO 24

Applique con sensore crepuscolare / Wall light with dusk sensor

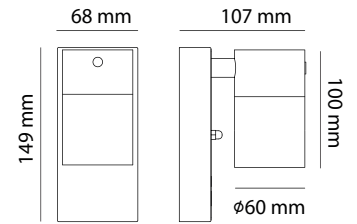

GU10 ALTA  
TEMPERATURA  
P. 98

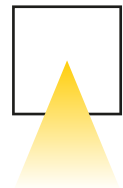

Fascio singolo  
Single beam

- \_ Applique da parete in alluminio con diffusore in vetro
- \_ Sensore crepuscolare con soglia di intervento 30-50lux
- \_ Attacco GU10 per sorgenti LED max 7W (modello suggerito GU10 alta temperatura)
- \_ Verniciatura a polveri resistente ai raggi UV

- \_ Aluminum wall light with glass diffuser
- \_ Twilight sensor with intervention threshold 30-50lux
- \_ GU10 base for LED light sources max 7W (suggested model high temperature GU10)
- \_ UV-resistant powder coating



W	BASE		VARIANTE	CODICE	EAN	
-	GU10	-	BIANCO / WHITE	AVILABS	8031453027773	1/20
-	GU10	-	ANTRACITE / ANTHRACITE	AVILAGS	8031453027780	1/20
-	GU10	-	CORTEN	AVILACS	8031453027797	1/20

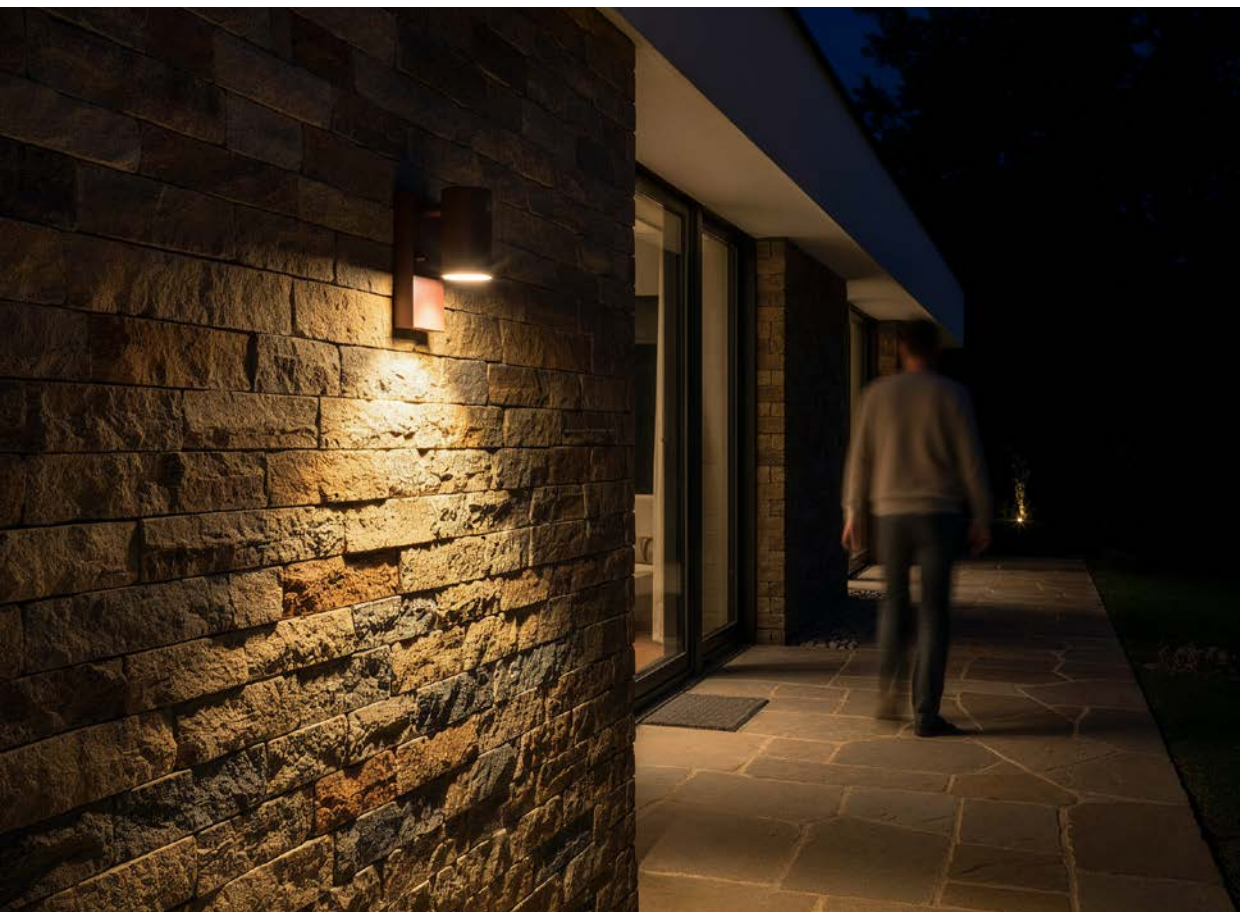
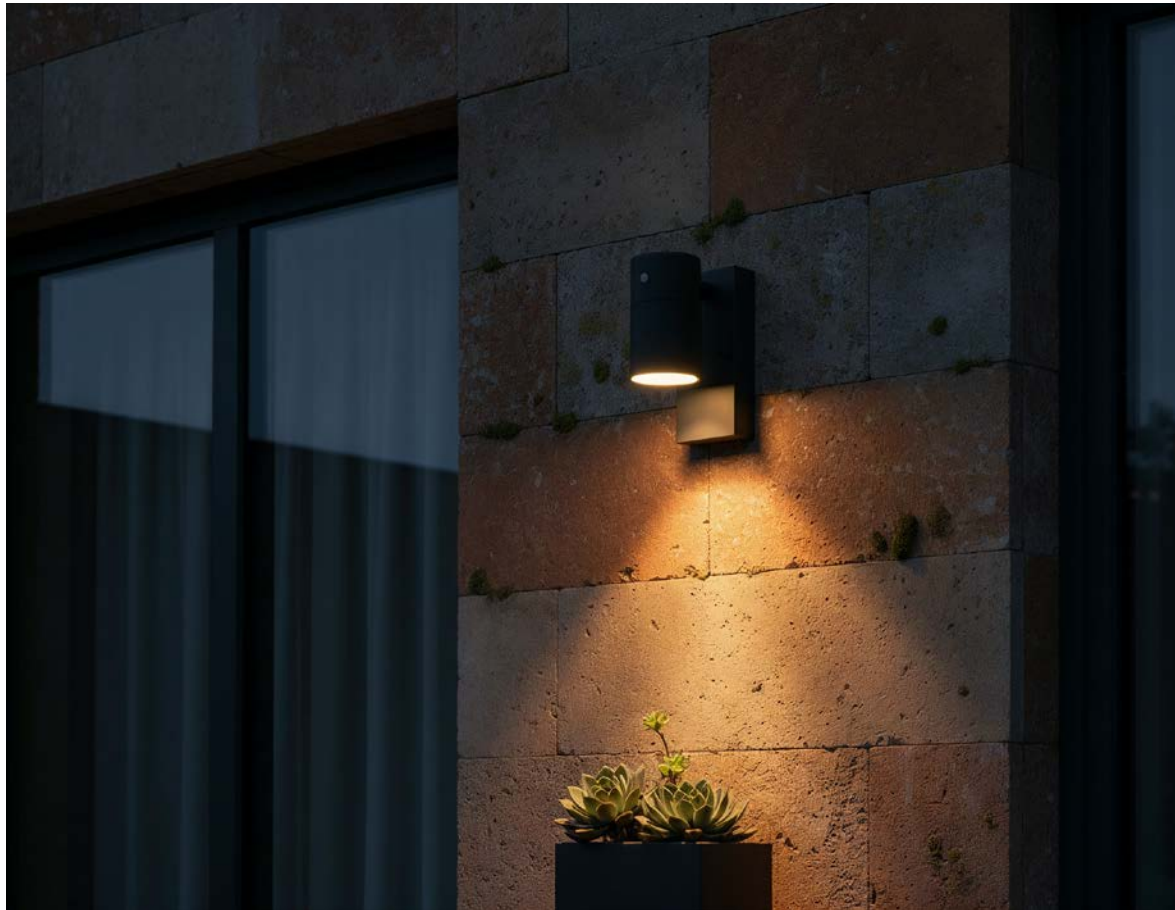

**AVILA**

# ALPPILA 1S

BTL CATEGORIA SCONTO 24

Applique singola emissione / Single emission wall lamp

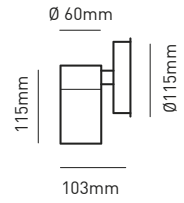

GU10 ALTA  
TEMPERATURA  
P. 98



Fascio singolo  
Single beam

- \_ Applique da parete in acciaio inox con schermo in vetro temperato per interni ed esterni
- \_ Attacco GU10 per sorgenti LED max 7W (modello suggerito GU10 alta temperatura)

- \_ Interior and exterior wall light in stainless steel with tempered glass diffuser
- \_ GU10 base for LED light sources max 7W (suggested model high temperature GU10)



W	BASE		VARIANTE	CODICE	EAN	
-	GU10	-	FISSA / FIXED	4107269	6435200147561	1/12

# ALPPILA 2S

BTL CATEGORIA SCONTO 24

Applique doppia emissione / Double emission wall lamp

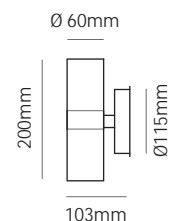

Fascio doppio  
Double beam

- Applique da parete in acciaio inox con schermo in vetro temperato per interni ed esterni
- Attacco GU10 per sorgenti LED max 2x7W (modello suggerito GU10 alta temperatura)

- Interior and exterior wall light in stainless steel with tempered glass diffuser
- GU10 base for LED light sources max 2x7W (suggested model high temperature GU10)



W	BASE		VARIANTE	CODICE	EAN	
-	GU10	-	ACCIAIO / STEEL	4107271	6435200147585	1/12

# ALPPILA XL

BTL CATEGORIA SCONTO 24

Applique doppia emissione / Double emission wall lamp

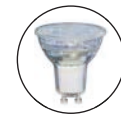
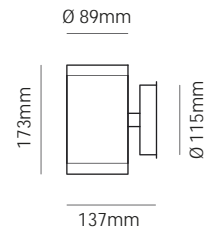

GU10 ALTA  
TEMPERATURA  
P. 98



Fascio doppio  
Double beam

- \_ Applique da parete in acciaio inox con schermo in vetro temperato per interni ed esterni
- \_ Attacco GU10 per sorgenti LED max 2x7W (modello suggerito GU10 alta temperatura)

- \_ Interior and exterior wall light in stainless steel with tempered glass diffuser
- \_ GU10 base for LED light sources max 2x7W (suggested model high temperature GU10)



W	BASE		VARIANTE	CODICE	EAN	
-	-	-	BIANCO / WHITE	<b>4508465</b>	6435200196163	1/12
-	-	-	ANTRACITE / ANTHRACITE	<b>4508466</b>	6435200196187	1/12

# GRANADA

BTL CATEGORIA SCONTO 24

Applique doppia emissione / Double emission wall lamp

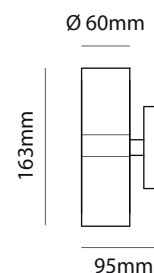

GU10 ALTA  
TEMPERATURA  
P. 98



Fascio doppio  
Double beam

- \_ Applique da parete in alluminio con diffusore in vetro per interni ed esterni
- \_ Attacco GU10 per sorgenti LED max 2x7W (modello suggerito GU10 alta temperatura)
- \_ Verniciatura a polveri resistente ai raggi UV

- \_ Aluminum wall light with glass diffuser for indoors and outdoors
- \_ GU10 base for LED light sources max 2x7W (suggested model high temperature GU10)
- \_ UV-resistant powder coating



W	BASE		VARIANTE	CODICE	EAN	
-	GU10	-	BIANCO / WHITE	<b>GRANADA2B</b>	8031453021900	1/20
-	GU10	-	ANTRACITE / ANTHRACITE	<b>GRANADA2G</b>	8031453021917	1/20
-	GU10	-	GRIGIO MARINA / LIGHT GREY	<b>GRANADA2M</b>	8031453021924	1/20

# GRANADA2

BTL CATEGORIA SCONTO 24

Applique singola emissione / Single emission wall lamp

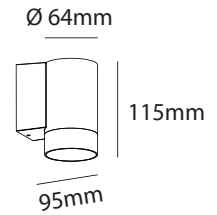

GU10 ALTA  
TEMPERATURA  
P. 98

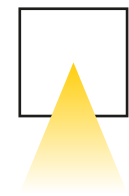

Fascio singolo  
Single beam

- \_ Applique da parete in alluminio con diffusore in vetro per interni ed esterni
- \_ Attacco GU10 per sorgenti LED max 7W (modello suggerito GU10 alta temperatura)
- \_ Verniciatura a polveri resistente ai raggi UV

- \_ Aluminum wall light with glass diffuser for indoors and outdoors
- \_ GU10 base for LED light sources max 7W (suggested model high temperature GU10)
- \_ UV-resistant powder coating



W	BASE		VARIANTE	CODICE	EAN	
-	GU10	-	BIANCO / WHITE	<b>GRANADA21B</b>	8031453026349	1/20
-	GU10	-	ANTRACITE / ANTHRACITE	<b>GRANADA21G</b>	8031453026332	1/20
-	GU10	-	CORTEN	<b>GRANADA21C</b>	8031453026356	1/20

# GRANADA2 DUO

BTL CATEGORIA SCONTO 24

Applique doppia emissione / Double emission wall lamp

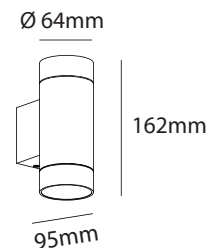

GU10 ALTA TEMPERATURA P. 98







Fascio doppio  
Double beam

- \_ Applique da parete in alluminio con diffusore in vetro per interni ed esterni
- \_ Attacco GU10 per sorgenti LED max 2x7W (modello suggerito GU10 alta temperatura)
- \_ Verniciatura a polveri resistente ai raggi UV

- \_ Aluminum wall light with glass diffuser for indoors and outdoors
- \_ GU10 base for LED light sources max 2x7W (suggested model high temperature GU10)
- \_ UV-resistant powder coating



W	BASE		VARIANTE	CODICE	EAN	
-	GU10	-	 BIANCO / WHITE	<b>GRANADA22B</b>	8031453026370	1/20
-	GU10	-	 ANTRACITE / ANTHRACITE	<b>GRANADA22G</b>	8031453026363	1/20
-	GU10	-	 CORTEN	<b>GRANADA22C</b>	8031453026387	1/20

# BARREL

BTL CATEGORIA SCONTO 24

Lanterna da muro / Wall mounted lantern

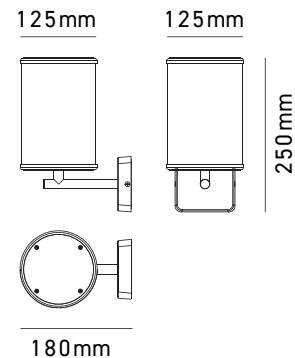

2 modalità di installazione  
2 types of installations

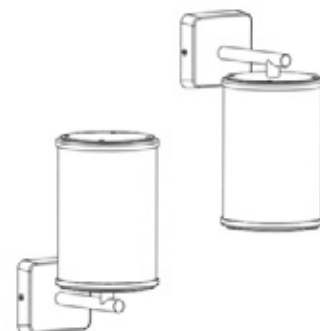

Questa applique è una rivisitazione in chiave moderna del classico concetto di lanterna da muro. La sua particolare progettazione permette l'installazione in configurazione up & down.

- \_ Lanterna da parete con corpo in alluminio e diffusore in policarbonato
- \_ Doppia possibilità di montaggio
- \_ Attacco E27 per sorgenti LED max 20W

*This wall light is a modern reinterpretation of the classic wall lantern concept. Its unique design allows for installation in an up & down configuration.*

- \_ Wall lantern with aluminum body and PC diffuser
- \_ Dual mounting options
- \_ E27 base for LED light sources max 20W



W	BASE		VARIANTE	CODICE	EAN	
-	E27	-	<input type="checkbox"/> BIANCA / WHITE	<b>BARRELE27B</b>	8031453033378	1/12
-	E27	-	<input checked="" type="checkbox"/> ANTRACITE / ANTHRACITE	<b>BARRELE27G</b>	8031453033385	1/12



**BARREL**

# JEREZ

Applique / Wall lamp





Questa applique da parete richiama alla mente i cortili di un tempo, ideali per illuminare facciate, ingressi esterni e corridoi. Il corpo in acciaio e l'ampia cupola in vetro permettono alla lampadina scelta di influenzare significativamente atmosfera e luminosità.

*This wall lamp evokes the courtyards of the past, making it ideal for illuminating facades, outdoor entrances, and corridors. The steel body and large glass dome allow the chosen bulb to significantly influence the atmosphere and brightness.*

- \_ Applique da parete in acciaio e diffusore in vetro
- \_ Attacco E27 per sorgenti LED max 20W

- \_ Wall lamp in steel with glass diffuser
- \_ E27 base for LED light sources max 20W



W	BASE		VARIANTE	CODICE	EAN	
-	E27	-	<input type="checkbox"/> BIANCA / WHITE	<b>JEREZ2E27B</b>	8031453033392	1/4
-	E27	-	<input checked="" type="checkbox"/> ANTRACITE / ANTHRACITE	<b>JEREZ2E27G</b>	8031453033415	1/4
-	E27	-	<input checked="" type="checkbox"/> CORTEN	<b>JEREZ2E27C</b>	8031453033408	1/4

## ARVIKA

Applique / Wall lamp

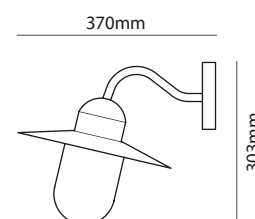

- \_ Apparecchio da parete tradizionale in acciaio e diffusore in vetro per l'illuminazione del giardino, terrazze etc...
- \_ Coperchio trasparente con vetro a bolla
- \_ Monta una sorgente led con attacco E27 - 60W max

- \_ Traditional wall luminaire made of aluminium with glass diffuser for the garden, terraces etc.
- \_ Transparent glass dome diffuser
- \_ Requires a LED light source with E27 base - 60W max



W	BASE		VARIANTE	CODICE	EAN	
-	E27	-	<input type="checkbox"/> BIANCO / WHITE	<b>4107297</b>	6435200157874	1/6
-	E27	-	<input checked="" type="checkbox"/> NERO / BLACK	<b>4107298</b>	6435200157898	1/6

# MAIORCA

BTL CATEGORIA SCONTO 24

Applique / Wall lamp

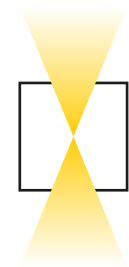
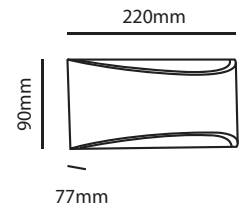
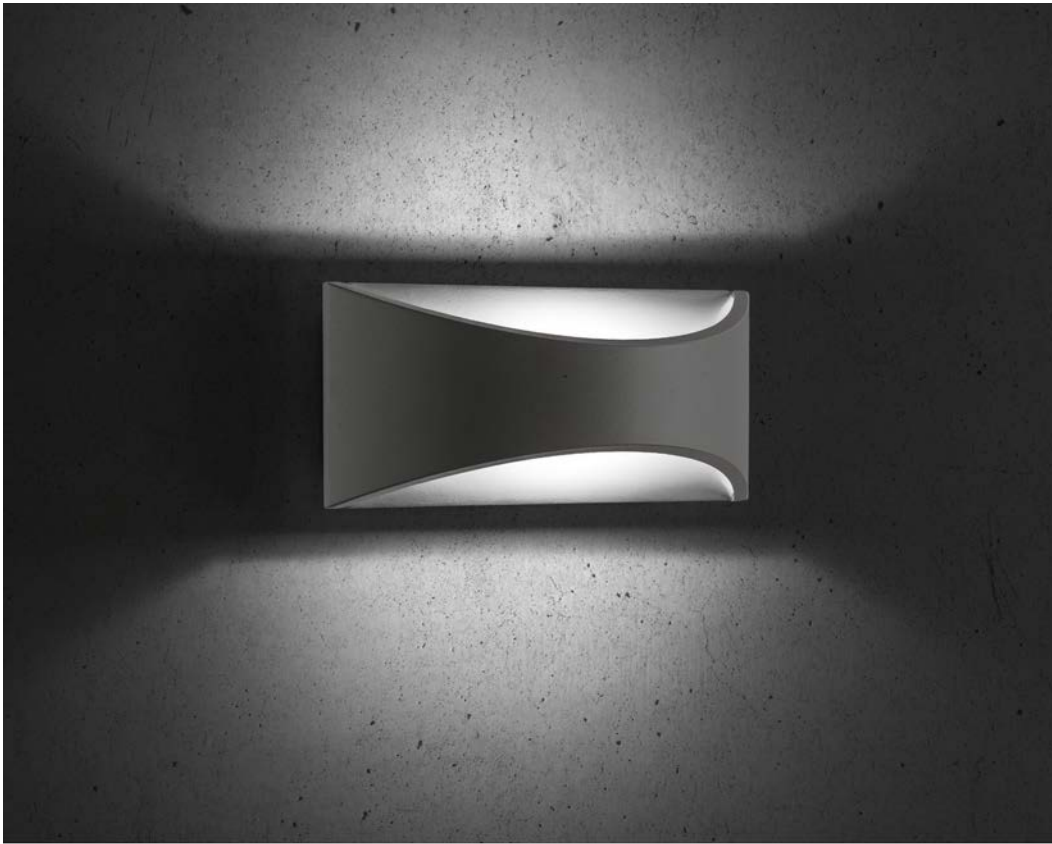

Fascio doppio  
Double beam

- \_ Applique da parete in alluminio per interni ed esterni
- \_ Modulo LED integrato da 7W (illuminazione indiretta)
- \_ CCT selezionabile

- \_ Interior and exterior wall light in aluminium
- \_ Built-in 7W LED module (indirect lighting)
- \_ Selectable CCT



W	K	LUMEN APPARECCHIO lm	LUMEN SORGENTE lm		VARIANTE	CODICE	EAN		
7	<input type="checkbox"/> 3000 <input type="checkbox"/> 4000 <input type="checkbox"/> 5000	420	870	120°	<input type="checkbox"/> BIANCO / WHITE	<b>MAIORCA6B</b>	8031453021993	1/20	
7	<input type="checkbox"/> 3000 <input type="checkbox"/> 4000 <input type="checkbox"/> 5000	250	870	120°	<input checked="" type="checkbox"/> GRIGIO MARINA / LIGHT GREY	<b>MAIORCA6M</b>	8031453022006	1/20	



**MAIORCA**

# SEGOVIA 1

BTL CATEGORIA SCONTO 24

Applique / Wall lamp



\*Solo per versione E27  
only for E27 version

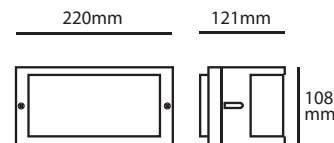

SEGVIAMOD  
modulo led di ricambio  
spare led module  
P. 234

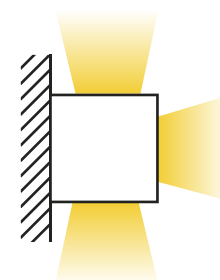

3 emissioni  
3 emissions

- \_ Applique da parete con corpo in alluminio e diffusore in policarbonato
- \_ Disponibile con modulo LED flicker-free sostituibile o attacco E27 max 20W LED
- \_ Modulo 3000K opzionale

- \_ Wall light with aluminium body and polycarbonate diffuser
- \_ Available with replaceable flicker-free LED module or E27 base max 20W LED
- \_ Optional 3000K module



W	BASE	K	LUMEN APPARECCHIO lm	LUMEN SORGENTE lm		VARIANTE	CODICE	EAN			
10	-	□	4000	720	1000	180	□ BIANCO / WHITE	SEGOVIA110B	8031453021122	1/12	A t g E
10	-	□	4000	560	1000	180	■ ANTRACITE / ANTHRACITE	SEGOVIA110G	8031453020774	1/12	A t g E
10	-	□	4000	540	1000	180	■ CORTEN	SEGOVIA110C	8031453020781	1/12	A t g E
-	E27	-	-	-	-	-	□ BIANCO / WHITE	SEGOVIA1E27B	8031453020835	1/12	-
-	E27	-	-	-	-	-	■ ANTRACITE / ANTHRACITE	SEGOVIA1E27G	8031453021153	1/12	-
-	E27	-	-	-	-	-	■ GRIGIO MARINA / LIGHT GREY	SEGOVIA1E27M	8031453023751	1/12	-
-	E27	-	-	-	-	-	■ CORTEN	SEGOVIA1E27C	8031453020842	1/12	-



**SEGOVIA 1**

# LAGOS 1

BTL CATEGORIA SCONTO 24

Applique / Wall lamp

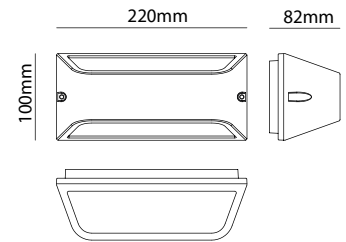

**LAGOSMOD**  
modulo led di ricambio / spare led module  
P. 235

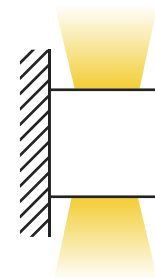

2 emissioni  
2 emissions

- Applique da parete con corpo in alluminio e diffusore in policarbonato
- Disponibile con attacco E27 max 20W LED o modulo LED da 9W con CCT selezionabile

- Wall light with aluminium body and polycarbonate diffuser
- Available with E27 base max 20W LED or selectable CCT 9W LED module



W	BASE	K	LUMEN APPARECCHIO lm	LUMEN SORGENTE lm		VARIANTE	CODICE	EAN		
9	-	<input type="checkbox"/> 3000 <input type="checkbox"/> 4000 <input type="checkbox"/> 5500	575	1000	180	<input type="checkbox"/> BIANCO / WHITE	<b>LAGOS110B</b>	8031453031466	1/12	
9	-	<input type="checkbox"/> 3000 <input type="checkbox"/> 4000 <input type="checkbox"/> 5500	400	1000	180	<input checked="" type="checkbox"/> CORTEN	<b>LAGOS110C</b>	8031453031473	1/12	
9	-	<input type="checkbox"/> 3000 <input type="checkbox"/> 4000 <input type="checkbox"/> 5500	390	1000	180	<input checked="" type="checkbox"/> ANTRACITE / ANTHRACITE	<b>LAGOS110G</b>	8031453031480	1/12	
-	E27		-	-	-	<input type="checkbox"/> BIANCO / WHITE	<b>LAGOS1E27B</b>	8031453031497	1/12	-
-	E27		-	-	-	<input checked="" type="checkbox"/> CORTEN	<b>LAGOS1E27C</b>	8031453031503	1/12	-
-	E27		-	-	-	<input checked="" type="checkbox"/> ANTRACITE / ANTHRACITE	<b>LAGOS1E27G</b>	8031453031510	1/12	-
-	E27		-	-	-	<input checked="" type="checkbox"/> GRIGIO MARINA / LIGHT GREY	<b>LAGOS1E27M</b>	8031453031527	1/12	-
-	E27		-	-	-	<input checked="" type="checkbox"/> NERO / BLACK	<b>LAGOS1E27N</b>	8031453031664	1/12	-

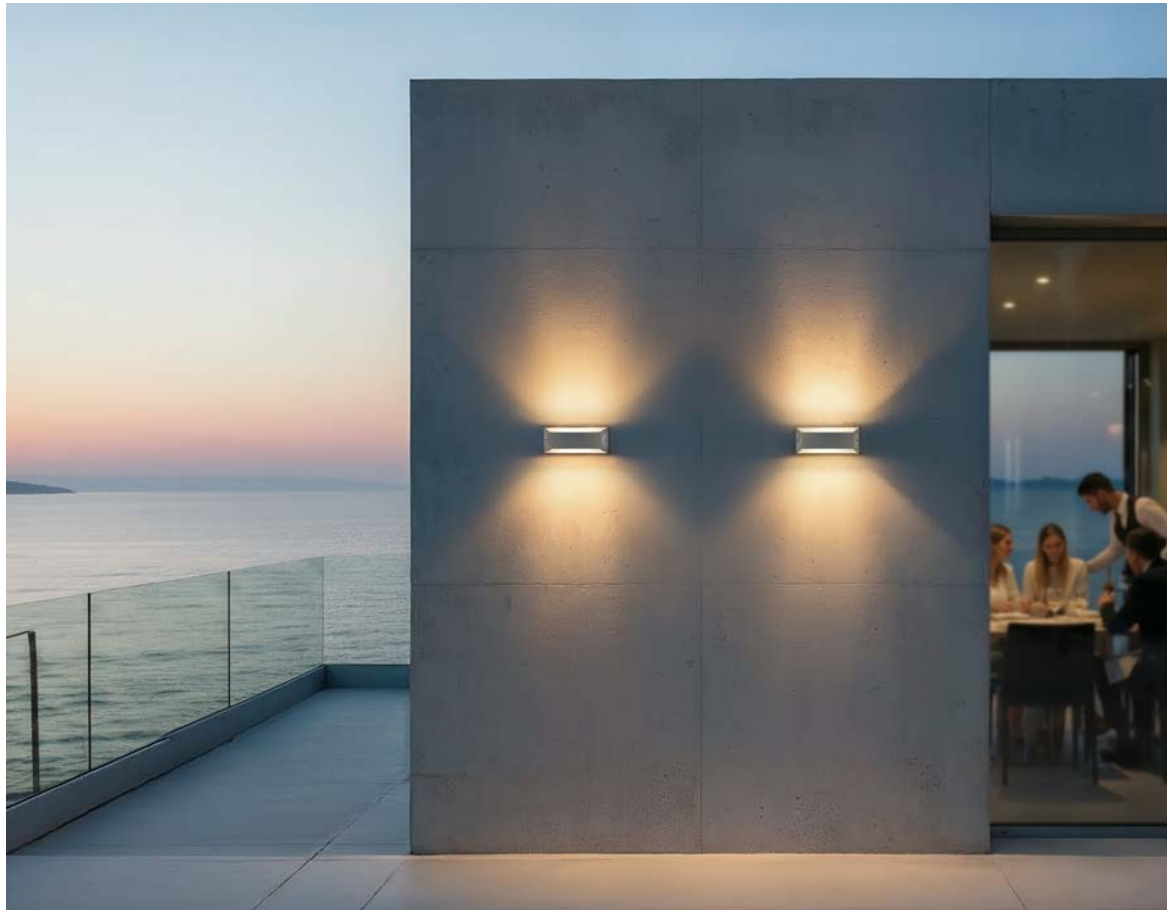

**LAGOS 1**

# LAGOS 2

BTL CATEGORIA SCONTO 24

Applique / Wall lamp

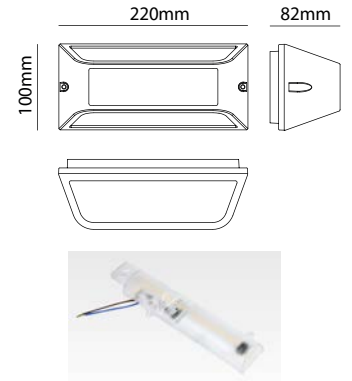

LAGOSMOD  
modulo led di ricambio / spare led module  
P. 235

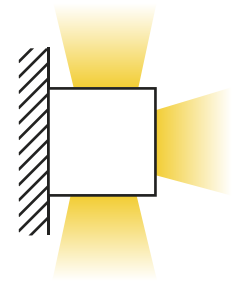

3 emissioni  
3 emissions

- Applique da parete con corpo in alluminio e diffusore in policarbonato
- Disponibile con attacco E27 max 20W LED o modulo LED da 9W con CCT selezionabile

- Wall light with aluminium body and polycarbonate diffuser
- Available with E27 base max 20W LED or selectable CCT 9W LED module



W	BASE	K	LUMEN APPARECCHIO lm	LUMEN SORGENTE lm		VARIANTE	CODICE	EAN		
9	-	<input type="checkbox"/> 3000 <input type="checkbox"/> 4000 <input type="checkbox"/> 5500	595	1000	180	<input type="checkbox"/> BIANCO / WHITE	LAGOS210B	8031453031534	1/12	
9	-	<input type="checkbox"/> 3000 <input type="checkbox"/> 4000 <input type="checkbox"/> 5500	420	1000	180	<input checked="" type="checkbox"/> CORTEN	LAGOS210C	8031453031541	1/12	
9	-	<input type="checkbox"/> 3000 <input type="checkbox"/> 4000 <input type="checkbox"/> 5500	410	1000	180	<input checked="" type="checkbox"/> ANTRACITE / ANTHRACITE	LAGOS210G	8031453031558	1/12	
-	E27		-	-	-	<input type="checkbox"/> BIANCO / WHITE	LAGOS2E27B	8031453031565	1/12	-
-	E27		-	-	-	<input checked="" type="checkbox"/> CORTEN	LAGOS2E27C	8031453031572	1/12	-
-	E27		-	-	-	<input checked="" type="checkbox"/> ANTRACITE / ANTHRACITE	LAGOS2E27G	8031453031589	1/12	-
-	E27		-	-	-	<input checked="" type="checkbox"/> GRIGIO MARINA / LIGHT GREY	LAGOS2E27M	8031453031596	1/12	-
-	E27		-	-	-	<input checked="" type="checkbox"/> NERO / BLACK	LAGOS2E27N	8031453031671	1/12	-



Installazione orizzontale o verticale  
*horizontal or vertical installation*

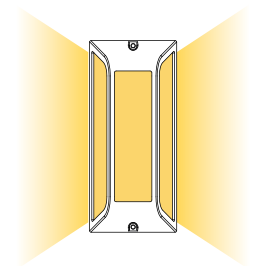
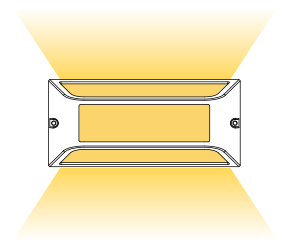

**LAGOS 2**

# VALENCIA

BTL CATEGORIA SCONTO 24

Applique / Wall lamp

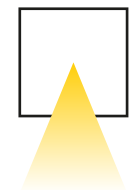
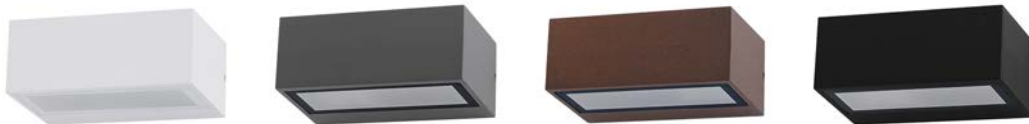
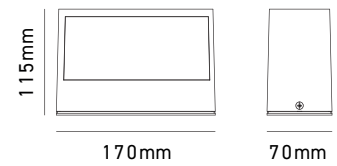

Fascio singolo  
Single beam

- \_ Applique da parete con corpo in alluminio e diffusore in vetro smerigliato
- \_ Attacco E27 per sorgenti LED max 20W. Dimensione massima lampadina 60mm di diametro e 125mm di lunghezza
- \_ Verniciatura a polveri resistente ai raggi UV

- \_ Wall light with aluminum body and frosted glass diffuser
- \_ E27 base for LED light sources max 20W. Maximum bulb size: 60mm in diameter and 125mm in length
- \_ UV-resistant powder coating



W	BASE		VARIANTE	CODICE	EAN	
	E27	-	BIANCA / WHITE	<b>VALENCIAE27B</b>	8031453027490	1/12
	E27	-	ANTRACITE / ANTHRACITE	<b>VALENCIAE27G</b>	8031453027483	1/12
	E27	-	CORTEN	<b>VALENCIAE27C</b>	8031453027506	1/12
	E27	-	NERO / BLACK	<b>VALENCIAE27N</b>	8031453033828	1/12



**VALENCIA**

# VALENCIA 2

BTL CATEGORIA SCONTO 24

Applique doppia emissione / Double emission wall lamp

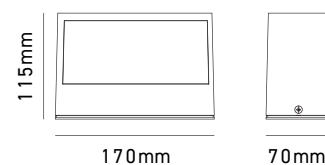

Fascio doppio  
Double beam





Applique in alluminio con un affascinante fascio luminoso up & down, ideale per aggiungere profondità e atmosfera a qualsiasi ambiente. Una soluzione moderna per un'illuminazione decorativa e funzionale, perfetta per interni ed esterni

- \_ Applique da parete con corpo in alluminio e diffusore in vetro smerigliato, doppia emissione
- \_ Attacco E27 per sorgenti LED max 20W. Dimensione massima lampadina 55mm di diametro e 125mm di lunghezza
- \_ Verniciatura a polveri resistente ai raggi UV

Aluminum wall light with a captivating up & down beam, ideal for adding depth and ambiance to any space. A modern solution for decorative and functional lighting, perfect for both indoor and outdoor use

- \_ Wall-mounted applique with aluminum body and frosted glass diffuser, dual emission
- \_ E27 base for LED light sources max 20W. Maximum bulb size: 55mm in diameter and 125mm in length
- \_ UV-resistant powder coating



W	BASE		VARIANTE	CODICE	EAN	
-	E27	-	 BIANCO / WHITE	<b>VALENCIA2E27B</b>	8031453032876	1/12
-	E27	-	 ANTRACITE / ANTHRACITE	<b>VALENCIA2E27G</b>	8031453032890	1/12
-	E27	-	 CORTEN	<b>VALENCIA2E27C</b>	8031453032883	1/12



**VALENCIA 2**

# VIGO 1

BTL CATEGORIA SCONTO 24



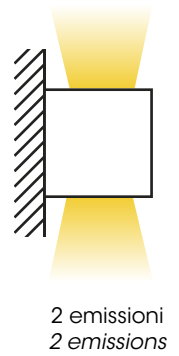
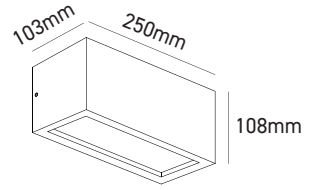

Applique / Wall lamp



- \_ Applique da parete con corpo in alluminio e diffusore in policarbonato
- \_ Attacco E27 per sorgenti LED max 20W

- \_ Wall light with aluminium body and polycarbonate diffuser
- \_ E27 base for LED light sources max 20W



W	BASE		VARIANTE	CODICE	EAN	
-	E27	-	 BIANCO / WHITE	VIGO1E27B	8031453026257	1/10
-	E27	-	 ANTRACITE / ANTHRACITE	VIGO1E27G	8031453026240	1/10
-	E27	-	 CORTEN	VIGO1E27C	8031453026264	1/10

# VIGO 2

BTL CATEGORIA SCONTO 24

Applique / Wall lamp

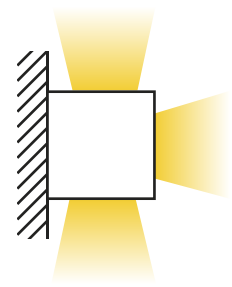
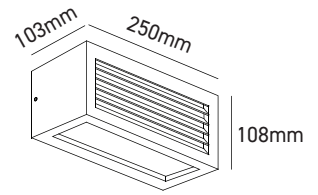





3 emissioni  
3 emissions



- \_ Applique da parete con corpo in alluminio e diffusore in policarbonato
- \_ Attacco E27 per sorgenti LED max 20W

- \_ Wall light with aluminium body and polycarbonate diffuser
- \_ E27 base for LED light sources max 20W



W	BASE		VARIANTE	CODICE	EAN	
-	E27	-	 BIANCO / WHITE	VIGO2E27B	8031453026288	1/10
-	E27	-	 ANTRACITE / ANTHRACITE	VIGO2E27G	8031453026271	1/10
-	E27	-	 CORTEN	VIGO2E27C	8031453026295	1/10

# VIGO 3

BTL CATEGORIA SCONTO 24

Applique / Wall lamp

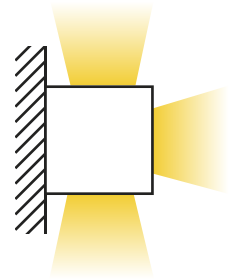
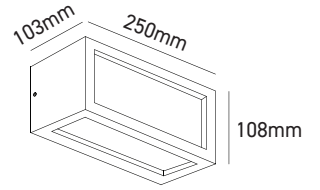





3 emissioni  
3 emissions



- \_ Applique da parete con corpo in alluminio e diffusore in policarbonato
- \_ Attacco E27 per sorgenti LED max 20W

- \_ Wall light with aluminium body and polycarbonate diffuser
- \_ E27 base for LED light sources max 20W



W	BASE		VARIANTE	CODICE	EAN	
-	E27	-	 BIANCO / WHITE	VIGO3E27B	8031453026318	1/10
-	E27	-	 ANTRACITE / ANTHRACITE	VIGO3E27G	8031453026301	1/10
-	E27	-	 CORTEN	VIGO3E27C	8031453026325	1/10

# VIGO 4

BTL CATEGORIA SCONTO 24

Applique / Wall lamp

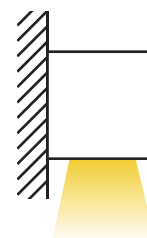
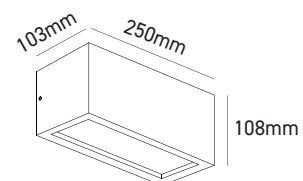





1 emissione  
1 emission



- \_ Applique da parete con corpo in alluminio e diffusore in policarbonato
- \_ Attacco E27 per sorgenti LED max 20W

- \_ Wall light with aluminium body and polycarbonate diffuser
- \_ E27 base for LED light sources max 20W



W	BASE		VARIANTE	CODICE	EAN	
-	E27	-	 BIANCO / WHITE	VIGO4E27B	8031453030940	1/10
-	E27	-	 ANTRACITE / ANTHRACITE	VIGO4E27G	8031453030957	1/10
-	E27	-	 CORTEN	VIGO4E27C	8031453030964	1/10





VIGO

# CADICE

BTL CATEGORIA SCONTO 24

Applique / Wall lamp

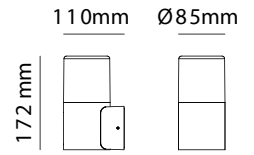

La semplicità si fa protagonista: una luce da parete che arricchisce i tuoi spazi con un'eleganza minimalista, discreta e moderna

*Simplicity takes center stage: a wall light that enriches your spaces with minimalist, discreet, and modern elegance*

- \_ Applique da parete con corpo in alluminio e diffusore in policarbonato opalino
- \_ Attacco E27 per sorgenti LED max 20W. Altezza massima 120mm

- \_ Wall light with aluminum body and opal polycarbonate diffuser
- \_ E27 base for LED light sources max 20W. Maximum bulb height 120mm



W	BASE		VARIANTE	CODICE	EAN	
-	E27	-	 ANTRACITE / ANTHRACITE	<b>CADICEE27G</b>	8031453027513	1/20
-	E27	-	 CORTEN	<b>CADICEE27C</b>	8031453032630	1/20

## CADICE BOLLARD

BTL CATEGORIA SCONTO 24

Paletto da giardino / Outdoor bollard

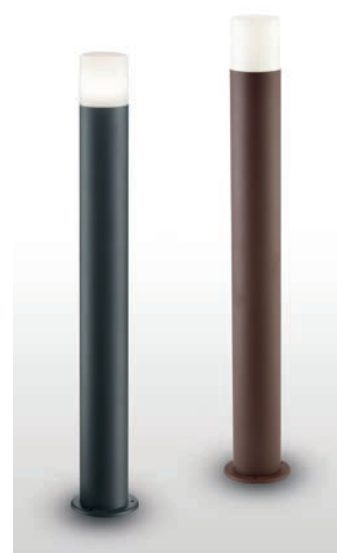
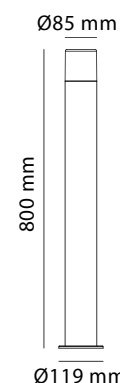





Un tocco di eleganza per il tuo giardino: linee minimaliste morbide ed arrotondate e un fascino senza tempo per illuminare con stile ogni angolo esterno

- \_ Bollard in alluminio con diffusore in policarbonato opalino
- \_ Attacco E27 per sorgenti LED max 20W. Altezza massima 120mm

*A touch of elegance for your garden: soft, rounded minimalistic lines and timeless charm to illuminate every outdoor corner with style*

- \_ Aluminum bollard with opal polycarbonate diffuser
- \_ E27 base for LED light sources max 20W. Maximum bulb height 120mm



W	BASE		VARIANTE	CODICE	EAN	
-	E27	-	 ANTRACITE / ANTHRACITE	<b>CADICEE27GP</b>	8031453027520	1/4
-	E27	-	 CORTEN	<b>CADICEE27CP</b>	8031453032647	1/4

# KALLIO

BTL CATEGORIA SCONTO 24

Paletto da giardino / Outdoor bollard

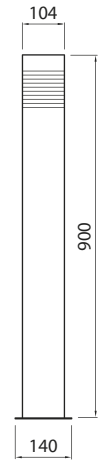

TUBOLARI T45  
P. 91

- \_ Corpo in acciaio inossidabile con diffusore in vetro
- \_ Versione verniciato a polvere con finitura opaca
- \_ Versione con rivestimento in pietra
- \_ Attacco E27 max 20W. Dimensione massima sorgente: diametro 45mm e lunghezza 155mm

- \_ Made from stainless steel with glass diffuser
- \_ Version with matt powder-coated paint finish
- \_ Version with stone cladding
- \_ E27 base, max 20W. Maximum source size: 45mm diameter and 155mm length



W	BASE		VARIANTE	CODICE	EAN	
-	E27	-	 ANTRACITE / ANTHRACITE	<b>4116122</b>	6435200188960	1/2
-	E27	-	 GRIGIO CHIARO / LIGHT GREY	<b>4107274</b>	6435200147646	1/2



**KALLIO**

# IBIZA

BTL CATEGORIA SCONTO 24

Paletto da giardino / Outdoor bollard

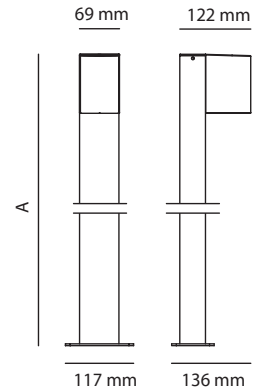

altezza / height A:  
IBIZA5 - 500 mm  
IBIZA10 - 1000 mm









GU10 ALTA  
TEMPERATURA  
P. 98



- \_ Bollard in alluminio con diffusore in vetro
- \_ Attacco GU10 per sorgenti LED max 7W (modello suggerito GU10 alta temperatura)
- \_ Fissaggio su piastra con tasselli
- \_ Verniciatura a polveri resistente ai raggi UV

- \_ Aluminum bollard with glass diffuser
- \_ GU10 base for LED light sources max 7W (suggested model high temperature GU10)
- \_ Fixing on plate with dowels
- \_ UV-resistant powder coating



W	BASE		VARIANTE	CODICE	EAN	
-	GU10	-	 ANTRACITE / ANTHRACITE	<b>IBIZA5G</b>	8031453027537	1/6
-	GU10	-	 CORTEN	<b>IBIZA5C</b>	8031453028855	1/6
-	GU10	-	 ANTRACITE / ANTHRACITE	<b>IBIZA10G</b>	8031453027544	1/4
-	GU10	-	 CORTEN	<b>IBIZA10C</b>	8031453028862	1/4

# MERIDA

BTL CATEGORIA SCONTO 24

Paletto da giardino / Outdoor bollard

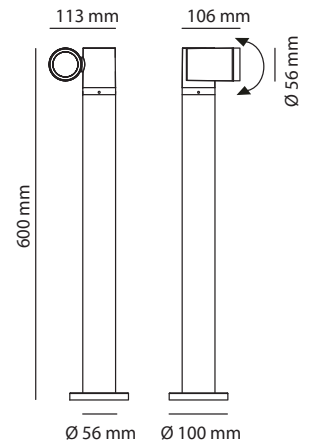

GU10 ALTA  
TEMPERATURA  
P. 98



- \_ Bollard in alluminio con diffusore in vetro
- \_ Testa orientabile
- \_ Attacco GU10 per sorgenti LED max 7W (modello suggerito GU10 alta temperatura)
- \_ Fissaggio su piastra con tasselli
- \_ Verniciatura a polveri resistente ai raggi UV

- \_ Aluminum bollard with glass diffuser
- \_ Adjustable head
- \_ GU10 base for LED light sources max 7W (suggested model high temperature GU10)
- \_ Fixing on plate with dowels
- \_ UV-resistant powder coating



W	BASE		VARIANTE	CODICE	EAN	
-	GU10	-	 ANTRACITE / ANTHRACITE	<b>MERIDA6G</b>	8031453027551	1/8
-	GU10	-	 CORTEN	<b>MERIDA6C</b>	8031453027575	1/8

# LEON P

BTL CATEGORIA SCONTO 24

Lanterna con paletto / Lantern lamp with pole

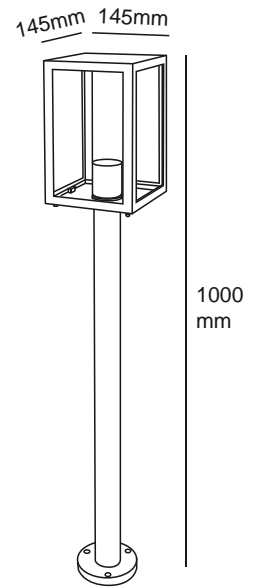

- \_ Lanterna con paletto e corpo in acciaio colore RAL7024 e schermi in vetro
- \_ Attacco E27 per sorgenti LED max 20W

- \_ Lantern with pole made from steel color RAL 7024 with glass shades
- \_ E27 base for LED light sources max 20W



W	BASE		VARIANTE	CODICE	EAN	
-	E27	-	■ ANTRACITE / ANTHRACITE	LEON1E27P	8031453025915	1/6

## LEON

BTL CATEGORIA SCONTO 24

Lantern / Lantern lamp

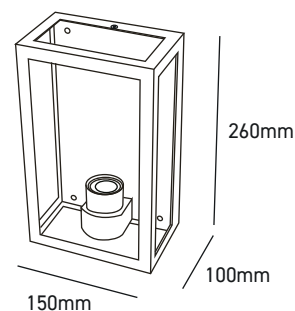

- \_ Lanterna da parete con corpo in acciaio colore RAL7024 e schermi in vetro
- \_ Attacco E27 per sorgenti LED max 20W

- \_ Wall lantern made from steel color RAL7024 with glass diffusers
- \_ E27 base for LED light sources max 20W



W	BASE		VARIANTE	CODICE	EAN	
-	E27	-	■ ANTRACITE / ANTHRACITE	LEON1E27	8031453025908	1/10

# LEON 12 FRAME

BTL CATEGORIA SCONTO 24

Lanterna da muro / Wall mounted lantern

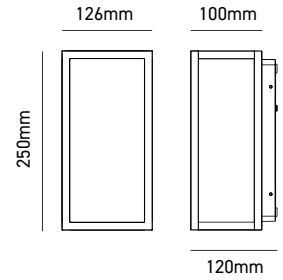

- \_ Lanterna da parete con corpo in alluminio
- \_ Modulo LED integrato da 13W
- \_ Illuminazione indiretta grazie alla sorgente nascosta nel frame dell'apparecchio
- \_ CCT selezionabile

- \_ Aluminum body wall lantern
- \_ 13W built-in LED module
- \_ Indirect lighting thanks to the light source hidden within the fixture frame
- \_ Selectable CCT



W	K	LUMEN APPARECCHIO lm	LUMEN SORGENTE lm		VARIANTE	CODICE	EAN		
13	<input type="checkbox"/> 3000 <input type="checkbox"/> 4000 <input type="checkbox"/> 5500	1000	1500	65°	<input type="checkbox"/> BIANCO / WHITE	LEON12FB	8031453034641	1/8	
13	<input type="checkbox"/> 3000 <input type="checkbox"/> 4000 <input type="checkbox"/> 5500	950	1500	65°	<input checked="" type="checkbox"/> CORTEN	LEON12FC	8031453034658	1/8	

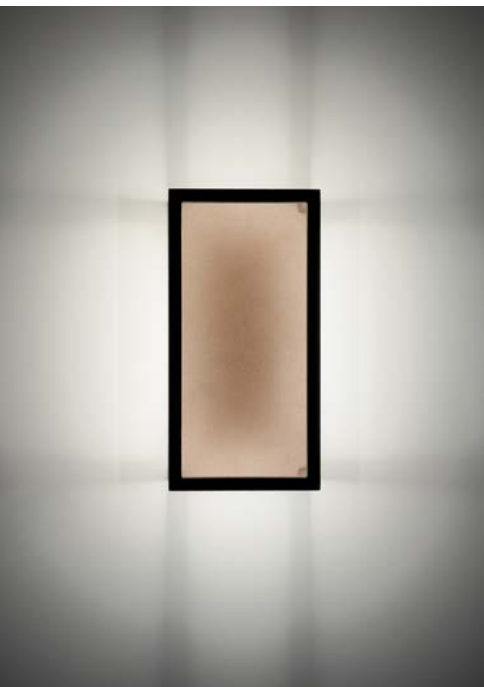
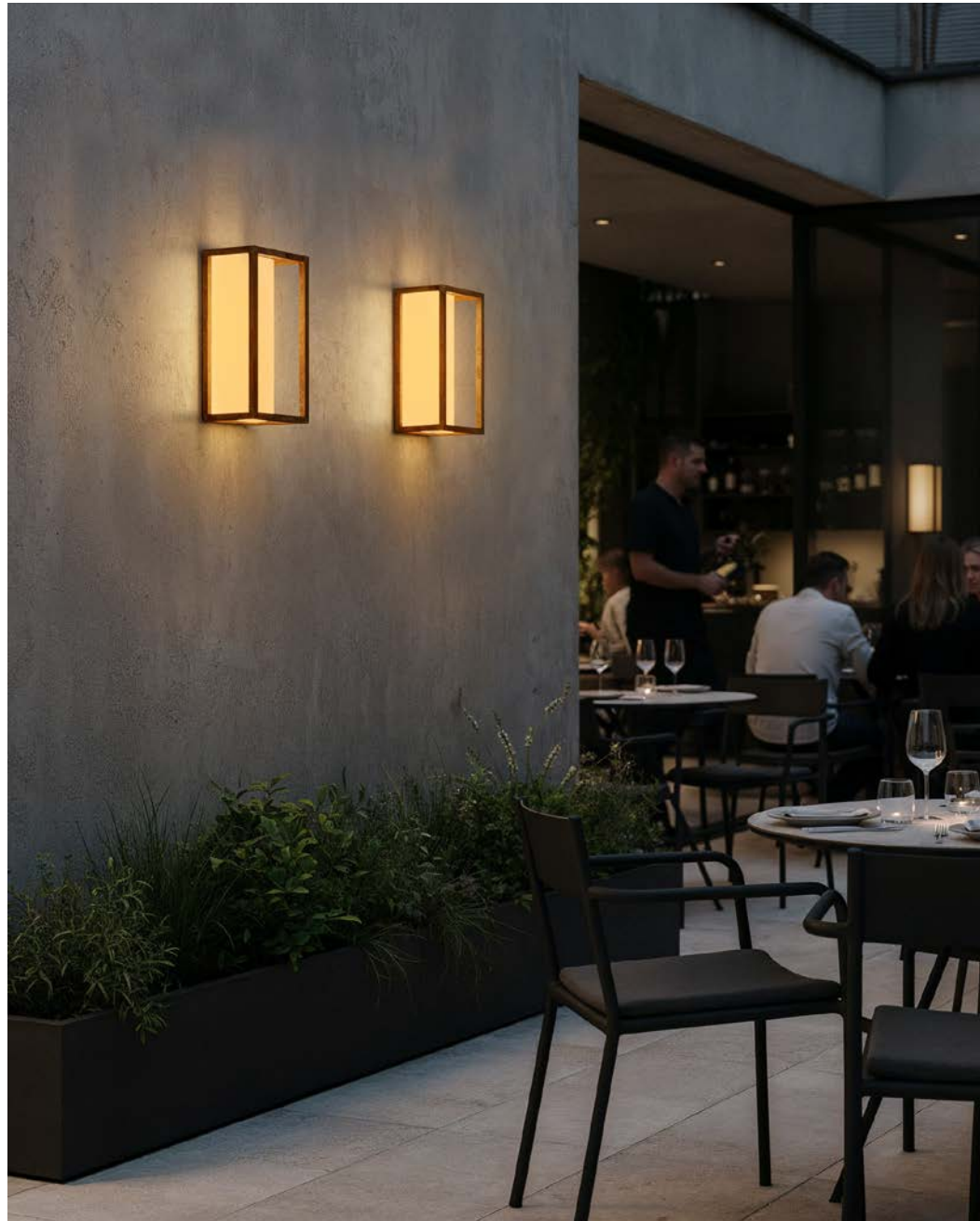

**LEON12F**

# LEON 12

BTL CATEGORIA SCONTO 24

Lanterna da muro / Wall mounted lantern

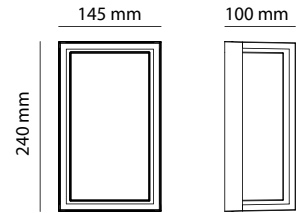

- \_ Lanterna da parete con corpo in alluminio e diffusore in policarbonato
- \_ Modulo LED integrato 12W
- \_ CCT selezionabile

- \_ Aluminum body and polycarbonate diffuser wall lantern
- \_ 12W built-in LED module
- \_ Selectable CCT



W	K	LUMEN APPARECCHIO lm	LUMEN SORGENTE lm		VARIANTE	CODICE	EAN		
12	<input type="checkbox"/> 3000 <input type="checkbox"/> 4000 <input type="checkbox"/> 5500	1200	1400	120°	<input type="checkbox"/> BIANCO / WHITE	<b>LEON12B</b>	8031453028824	1/8	
12	<input type="checkbox"/> 3000 <input type="checkbox"/> 4000 <input type="checkbox"/> 5500	1200	1400	120°	<input checked="" type="checkbox"/> CORTEN	<b>LEON12C</b>	8031453028831	1/8	



**LEON 12**

# LEON 2

BTL CATEGORIA SCONTO 24

Plafoniera / Ceiling lamp

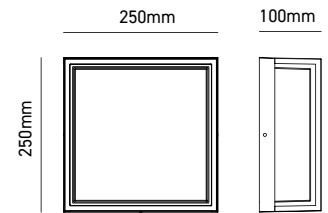





Plafoniera in alluminio progettata per combinare robustezza e stile in un'unica soluzione. Grazie alla protezione IP65, è ideale per ambienti esterni, mentre il design essenziale con doppia lampadina E27 aggiunge un tocco contemporaneo e versatile, adatta per soffitto e parete. Perfetta per ogni esigenza di illuminazione

*Aluminum ceiling light designed to combine durability and style in a single solution. With IP65 protection, it is ideal for outdoor environments, while the sleek design with dual E27 bulbs adds a contemporary and versatile touch, suitable for both ceiling and wall mounting. Perfect for any lighting need*

- \_ Plafoniera con corpo in alluminio e diffusore in policarbonato
- \_ Doppio attacco E27 per sorgenti LED max 20W. Diametro massimo lampadina 60mm.

- \_ *Ceiling light with aluminum body and polycarbonate diffuser*
- \_ *Double E27 socket for LED sources max 20W. Maximum bulb diameter 60mm.*



W	BASE		VARIANTE	CODICE	EAN	
-	E27	-	 BIANCO / WHITE	<b>LEON2E27B</b>	8031453030889	1/6
-	E27	-	 ANTRACITE / ANTHRACITE	<b>LEON2E27G</b>	8031453032517	1/6
-	E27	-	 CORTEN	<b>LEON2E27C</b>	8031453030896	1/6



**LEON 2**

Picchetto da giardino / Outdoor stake light

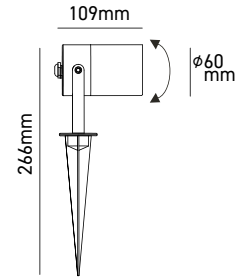







GU10 ALTA  
TEMPERATURA  
P. 98



- \_ Picchetto decorativo in alluminio per giardini o sentieri
- \_ Inclinazione regolabile
- \_ Cavo lunghezza 30cm con connettore IP68
- \_ Attacco GU10 per sorgenti LED max 7W (modello suggerito GU10 alta temperatura)

- \_ Aluminium decorative stake light for gardens or paths
- \_ Adjustable head
- \_ Supplied with 30 cm cable and IP68 connector
- \_ GU10 base for LED light sources max 7W (suggested model high temperature GU10)



	W	BASE		VARIANTE	CODICE	EAN	
NEW	-	GU10	-	 BIANCO / WHITE	<b>SPIKY1B</b>	8031453035266	1/20
	-	GU10	-	 ANTRACITE / ANTHRACITE	<b>SPIKY1</b>	8031453025922	1/20
	-	GU10	-	 CORTEN	<b>SPIKY1C</b>	8031453027568	1/20
	-	GU10	-	 VERDE / GREEN	<b>SPIKY1V</b>	8031453032715	1/20

# SPIKY2

BTL CATEGORIA SCONTO 24

Picchetto da giardino / Outdoor stake light

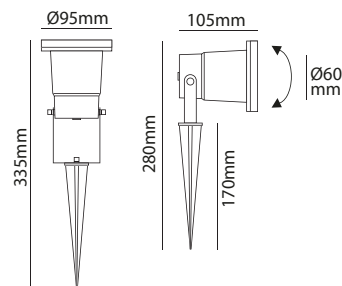

GU10 ALTA  
TEMPERATURA  
P. 98



- \_ Picchetto decorativo in alluminio per giardini o sentieri
- \_ Inclinazione regolabile
- \_ Cavo lunghezza 30cm con connettore IP68
- \_ Attacco GU10 per sorgenti LED max 7W (modello suggerito GU10 alta temperatura)
- \_ GU10 altezza max 55mm

- \_ Aluminium decorative stake light for gardens or paths
- \_ Adjustable head
- \_ Supplied with 30 cm cable and IP68 connector
- \_ GU10 base for LED light sources max 7W (suggested model high temperature GU10)
- \_ GU10 max height 55mm



W	BASE		VARIANTE	CODICE	EAN	
-	GU10	-	■ ANTRACITE / ANTHRACITE	SPIKY2	8031453025939	1/20

# SPIKY3

BTL CATEGORIA SCONTO 24

Picchetto da giardino regolabile / Adjustable outdoor stake light

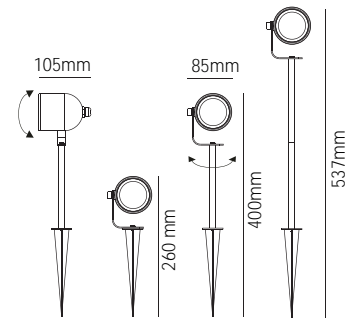

**GU10 ALTA  
TEMPERATURA**  
P. 98

Picchetto compatto con altezza regolabile, resistente alle intemperie, si integra perfettamente in ogni contesto outdoor. Una soluzione ideale per valorizzare giardini, vialetti e aree esterne.

- \_ Picchetto decorativo in alluminio per giardini o sentieri
- \_ Inclinazione regolabile
- \_ Cavo lunghezza 50cm con connettore IP68
- \_ Doppio stelo incluso per regolare l'altezza a piacimento
- \_ Attacco GU10 per sorgenti LED max 7W e altezza max 60mm (modello suggerito GU10 alta temperatura)

Compact stake with adjustable height, weather-resistant, and perfectly integrates into any outdoor setting. An ideal solution to enhance gardens, pathways, and outdoor areas.

- \_ Aluminium decorative stake for gardens or pathways
- \_ Adjustable tilt
- \_ 50cm cable with IP68 connector
- \_ Double stem included to adjust the height as desired
- \_ GU10 socket for LED sources max 7W and max height 60mm (suggested model: high-temperature GU10)



W	BASE		VARIANTE	CODICE	EAN	
-	GU10	-	CORTEN	<b>SPIKY3LC</b>	8031453033255	1/12
-	GU10	-	NERO / BLACK	<b>SPIKY3LN</b>	8031453033248	1/12
-	GU10	-	VERDE / GREEN	<b>SPIKY3LV</b>	8031453033361	1/12



**SPIKY3**

Picchetto da giardino / Outdoor stake light



INSTALLABILE ANCHE A PARETE  
CAN BE INSTALLED ON THE WALL



- \_ Picchetto decorativo di forma quadrata
- \_ Inclinazione regolabile
- \_ Cavo lunghezza 30cm con connettore IP68
- \_ Modulo LED integrato da 7W
- \_ Possibilità di installazione a parete o soffitto

- \_ Square-shaped decorative stake
- \_ Adjustable head
- \_ Supplied with 30cm cable and IP68 connector
- \_ Built-in 7W LED module
- \_ Can be installed on wall or ceiling



W	K	LUMEN APPARECCHIO lm	LUMEN SORGENTE lm		VARIANTE	CODICE	EAN		
7	3000	500	550	40°	BIANCO / WHITE	SPIQO1B	8031453034870	1/20	
7	3000	500	550	40°	CORTEN	SPIQO1C	8031453034887	1/20	
7	3000	500	550	40°	NERO / BLACK	SPIQO1N	8031453034894	1/20	
7	3000	500	550	40°	VERDE / GREEN	SPIQO1V	8031453034900	1/20	



**SPIQO**



Spot Light LED 24V / 24V LED Spot Light

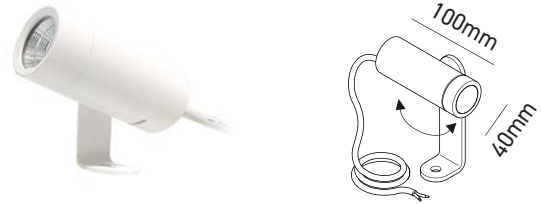

- Spot decorativo in alluminio per interni ed esterni
- Inclinazione regolabile
- Modulo LED integrato da 3W
- Cavo H05RN-F 2x1mm<sup>2</sup> di lunghezza 150cm
- Possibilità di installazione a parete o soffitto
- In opzione triplo stelo da 30cm per regolare l'altezza a piacimento più picchetto per installazione su terreno
- In opzione base di fissaggio in alluminio per installazione a superficie
- In opzione driver 24V,35W, IP65 compreso di connettore IP68
- In opzione connettore IP68 a tre vie per installazioni multiple

- Decorative aluminum spotlight for indoor and outdoor use
- Adjustable tilt
- Integrated 3W LED module
- H05RN-F 2x1mm<sup>2</sup> cable, 150cm length
- Wall or ceiling installation option
- Optional 30cm triple stem for adjustable height plus ground spike for ground installation
- Optional aluminum surface mounting base
- Optional 24V, 35W, IP65 driver with IP68 connector
- Optional 3-way IP68 connector for multiple installations

IP 65
24V DC
III
30.000h  
3 ANNI GARANZIA
-20°+45°
⚡
🏠

W	K	LUMEN APPARECCHIO lm	LUMEN SORGENTE lm		VARIANTE	CODICE	EAN			
3		3000	300	360	60°	BIANCO / WHITE	<b>JET33BDC</b>	8031453034993	1/10	
3		3000	300	360	60°	CORTEN	<b>JET33CDC</b>	8031453035006	1/10	
3		3000	300	360	60°	NERO / BLACK	<b>JET33NDC</b>	8031453035013	1/10	

**JET ACCESSORI** NEW

BTL CATEGORIA SCONTO 24

accessories

**Configurazioni con accessorio JETPOLEN**  
Configurations with JETPOLEN accessory



**JETPOLEN + JETBASEN**  
accessori / accessories



Accessorio / Accessory

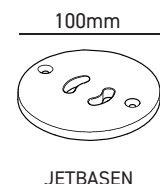
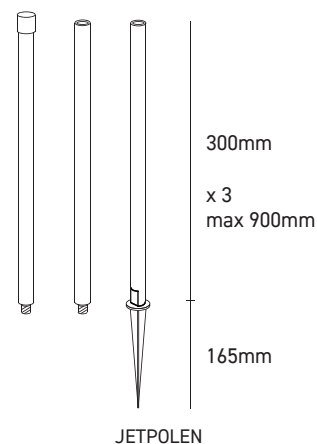

Vedi esempi  
Example see  
P. 410



**ACCESSORIO**

**CODICE**

**EAN**



Base di fissaggio nera per JET / Black fixing base for JET	<b>JETBASEN</b>	8031453035037	1
Picchetto e 3x30cm di stelo neri per JET / Black stake and 3x30cm stem for JET	<b>JETPOLEN</b>	8031453035020	1
Connettore stagno IP68 a tre vie a due poli / IP68 waterproof three-way two-pole connector	<b>C2IP68DC</b>	8031453035044	1

# JET

Esempi configurazioni / Configuration examples

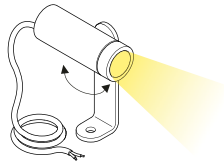

JET33  
Spotlight

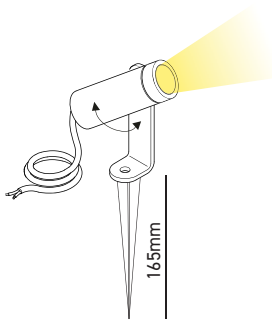

JET33  
+  
JETPOLEN  
(no steli / no stakes)

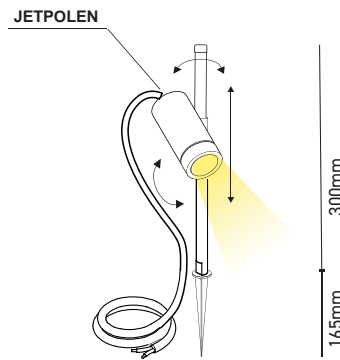

JET33  
+  
JETPOLEN  
(1 stelo / 1 stake) 300mm

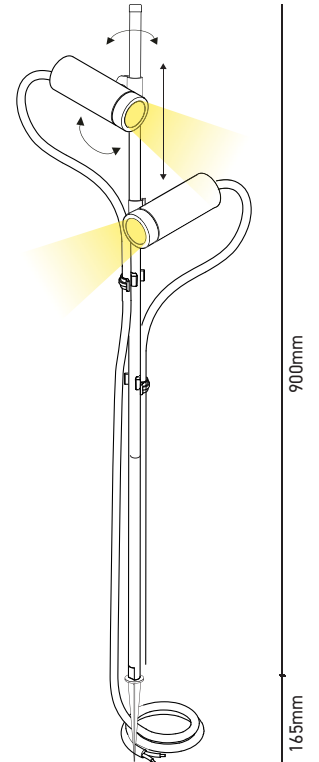

2 x JET33  
+  
JETPOLEN  
(3 steli / 3 stakes) 900mm

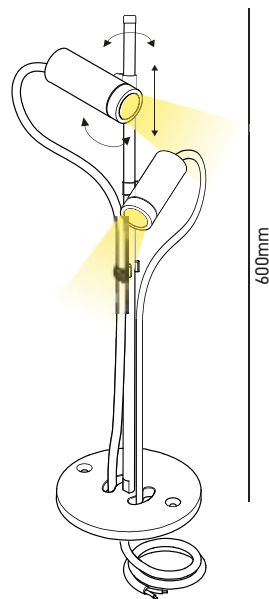

2 x JET33  
+  
JETPOLEN  
(2 steli / 2 stakes) 600mm  
+  
JETBASEN  
base di fissaggio / fixing base

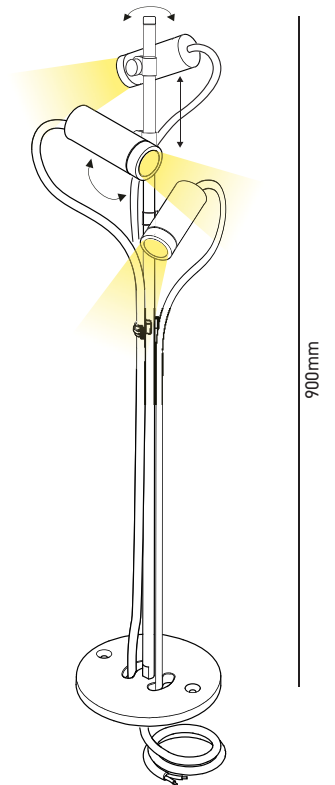

3 x JET33  
+  
JETPOLEN  
(3 steli / 3 stakes) 900mm  
+  
JETBASEN  
base di fissaggio / fixing base



**JET**

# GARDA DESK

BTL CATEGORIA SCONTO 24

Lampada da tavolo per esterni / Outdoor table lamp

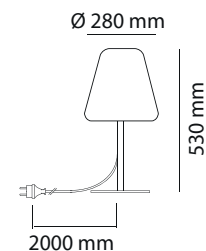

- \_ Lampada da tavolo dall'aspetto moderno adatta sia ad usi all'interno che aree esterne come terrazzi, balconi e giardini.
- \_ Corpo realizzato in acciaio verniciato a polvere di colore antracite RAL 7024 e diffusore in polietilene con protezione UV di colore bianco.
- \_ Cavo di alimentazione da 2m H05RN-F 2X1,0 mm<sup>2</sup> dotato di spina Schuko (16A 250V).
- \_ Attacco E27 per sorgenti LED max 25W

- \_ *Modern looking table lamp suitable for indoor spaces and outdoor as well like gardens, terraces and balconies*
- \_ *RAL 7024 Anthracite powder-coated steel body and white UV protected PE diffuser.*
- \_ *2m H05RN-F 2X1,0 mm<sup>2</sup> power cord with Schuko terminal plug (16A 250V).*
- \_ *E27 base for LED light sources max 25W*



W	BASE		VARIANTE	CODICE	EAN	
-	E27	-	-	<b>GARDA</b>	8031453031893	1



**GARDA**

# GARDA FLOOR

BTL CATEGORIA SCONTO 24

Lampada da terra per esterni / Outdoor floor lamp

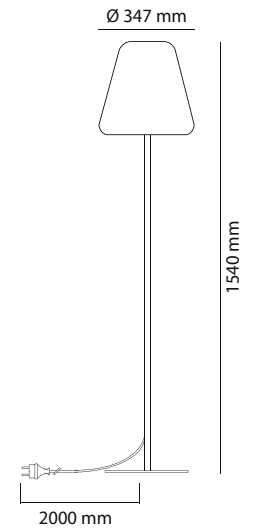

- \_ Lampada da terra dall'aspetto moderno adatta sia ad usi all'interno che aree esterne come terrazzi, balconi e giardini.
- \_ Corpo realizzato in acciaio verniciato a polvere di colore antracite RAL 7024 e diffusore in polietilene con protezione UV di colore bianco.
- \_ Cavo di alimentazione da 2m H05RN-F 2X1,0 mm<sup>2</sup> dotato di spina Schuko (16A 250V).
- \_ Attacco E27 per sorgenti LED max 25W

- \_ *Modern looking floor lamp suitable for indoor spaces and outdoor as well like gardens, terraces and balconies*
- \_ *RAL 7024 Anthracite powder-coated steel body and white UV protected PE diffuser.*
- \_ *2m H05RN-F 2X1,0 mm<sup>2</sup> power cord with Schuko terminal plug (16A 250V).*
- \_ *E27 base for LED light sources max 25W*



W	BASE		VARIANTE	CODICE	EAN	
-	E27	-	-	GARDAL	8031453031909	1



**GARDA L**



**SHOT**  
BOT LIGHTING

**RESIDENZIALE / SEGNAPASSI**  
RESIDENTIAL / STEP LIGHTS

# ARONA 2

BTL CATEGORIA SCONTO 24

Segnapasso CCT / CCT step light

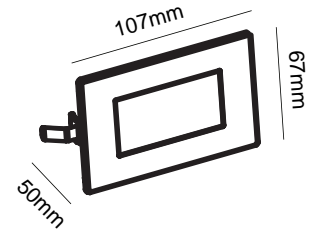

- \_ Segnapasso in policarbonato
- \_ Cover metalliche in dotazione colore bianco, nero e acciaio spazzolato
- \_ Disponibile con fascio simmetrico ed asimmetrico
- \_ Variante con fascio simmetrico disponibile anche con modulo di emergenza 2 h di autonomia - IP20
- \_ CCT selezionabile
- \_ Compatibile con scatola 503 (non inclusa)

- \_ Polycarbonate steplight
- \_ Metal covers supplied in white, black and brushed steel
- \_ Available with symmetrical and asymmetrical beam
- \_ Symmetrical beam version also available with emergency module providing 2 hours of autonomy - IP20 rated
- \_ Selectable CCT
- \_ Compatible with 503 formwork (not included)



W	K	LUMEN APPARECCHIO lm	LUMEN SORGENTE lm		VARIANTE	CODICE	EAN			
2,5	3000	150	240	120°	-	ARONA303	8031453027155	1/100		
	4000									
	6000									
3	3000	150	170	120°	EMERGENZA / EMERGENCY *	ARONA303EM	8031453027162	1/60		
	4000									
	6000									
2,5	3000	150	300	38°	ASIMMETRICO / ASYMMETRIC	ARONA304	8031453034498	1/100		
	4000									
	6000									

# ARONA 3

Segnapasso CCT / CCT step light

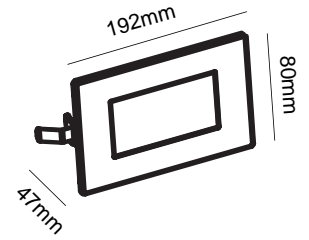

- \_ Segnapasso in policarbonato
- \_ Disponibile anche in variante con modulo di emergenza 2 h di autonomia
- \_ CCT selezionabile
- \_ Compatibile con scatola 506 (non inclusa)

- \_ Polycarbonate steplight
- \_ Also available in emergency light version - autonomy period 2h
- \_ Selectable CCT
- \_ Compatible with 506 formwork (not included)

IP 65
220-240V
25.000h 3 ANNI GARANZIA
-20°+45°
CCT
EMERGENCY
2 h

W	K	LUMEN APPARECCHIO lm	LUMEN SORGENTE lm	°	VARIANTE	CODICE	EAN		
4,5	<input type="checkbox"/> 3000 <input type="checkbox"/> 4000 <input type="checkbox"/> 6000	320	430	120°	<input type="checkbox"/> BIANCO / WHITE	<b>ARONA601</b>	8031453027179	1/50	<b>F</b>
3,5	<input type="checkbox"/> 3000 <input type="checkbox"/> 4000 <input type="checkbox"/> 6000	140	180	120°	EMERGENZA / EMERGENCY *	<b>ARONA601EM</b>	8031453027186	1/50	<b>G</b>

# ARONA 1

BTL CATEGORIA SCONTO 24

Segnapasso CCT / CCT step light

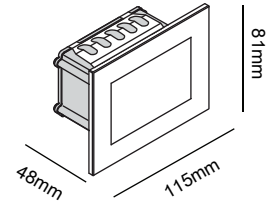
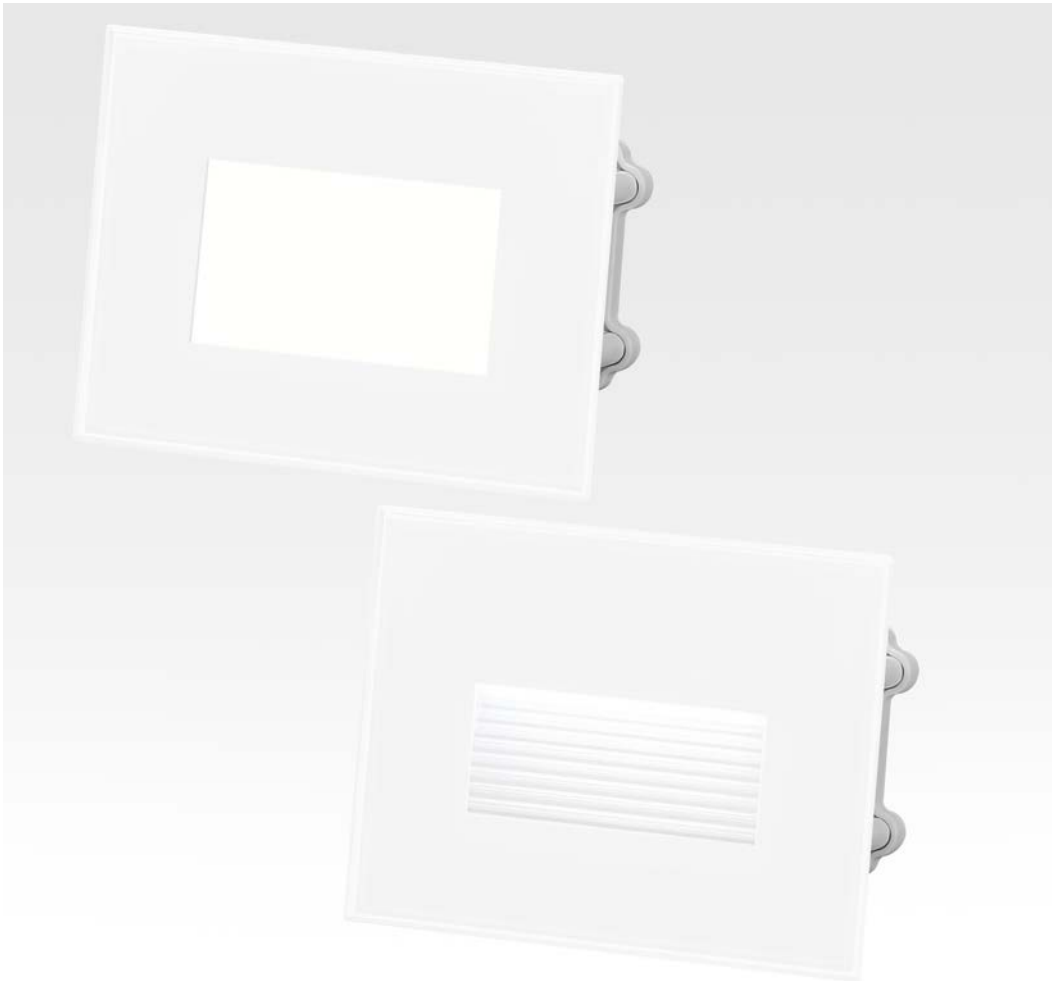

- \_ Segnapasso in alluminio pressofuso bianco con diffusore in vetro
- \_ Disponibile con fascio simmetrico ed asimmetrico
- \_ Modulo LED integrato da 4,5W
- \_ CCT selezionabile
- \_ Compatibile con scatola 503 (non inclusa)

- \_ White die-cast aluminum steplight with glass diffuser
- \_ Available with symmetrical and asymmetrical beam
- \_ Built-in 4,5W LED module
- \_ Selectable CCT
- \_ Compatible with 503 formwork (not included)



W	K	LUMEN APPARECCHIO lm	LUMEN SORGENTE lm		VARIANTE	CODICE	EAN		
4,5	<input type="checkbox"/> 3000 <input type="checkbox"/> 4000 <input type="checkbox"/> 6000	240	320	120°	SIMMETRICO / SYMMETRICAL	<b>ARONA301</b>	8031453027131	1/40	
4,5	<input type="checkbox"/> 3000 <input type="checkbox"/> 4000 <input type="checkbox"/> 6000	150	320	38°	ASIMMETRICO / ASYMMETRICAL	<b>ARONA302</b>	8031453027148	1/40	

# ARONA 4 NEW

BTL CATEGORIA SCONTO 24

Segnapasso CCT / CCT step light

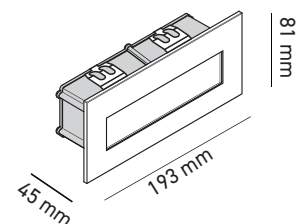
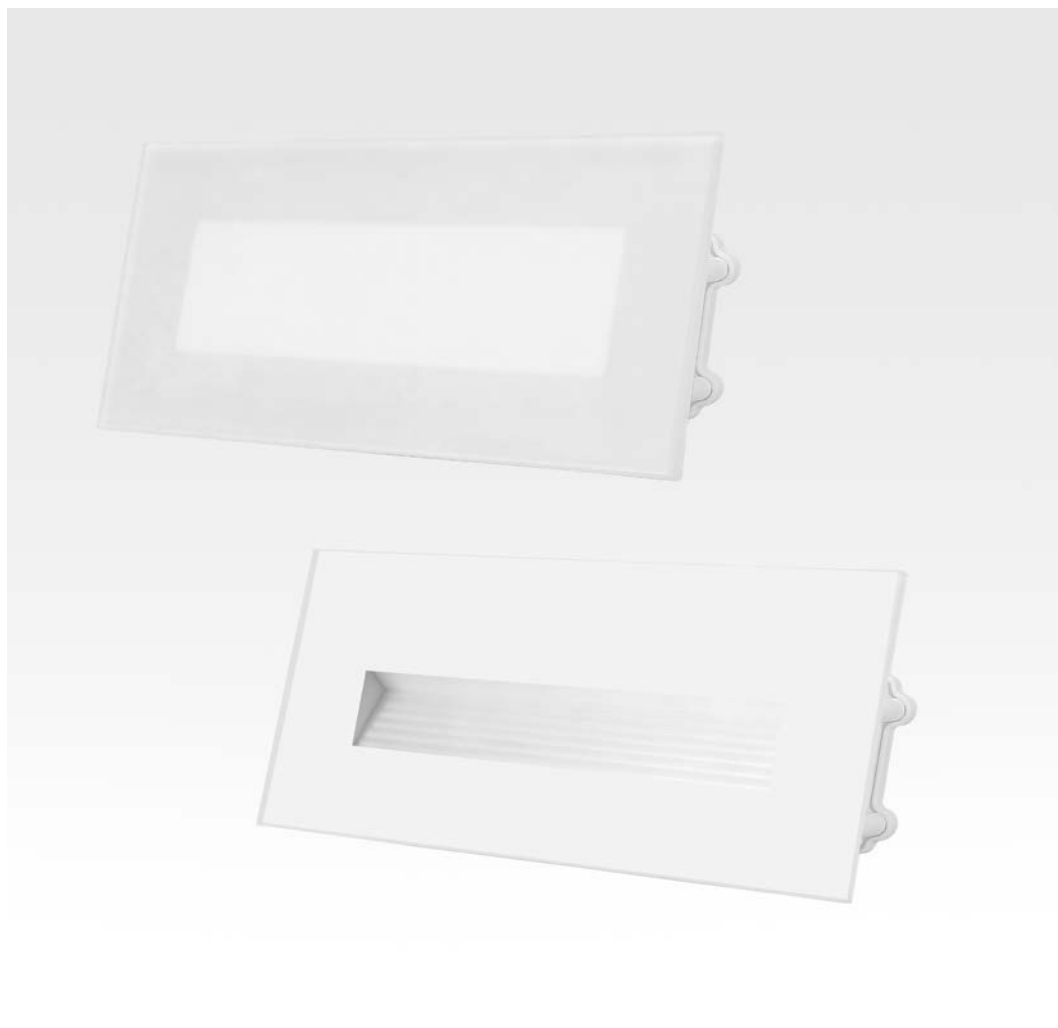

- \_ Segnapasso in policarbonato con diffusore in vetro
- \_ Disponibile con fascio simmetrico ed asimmetrico
- \_ Modulo LED integrato da 6W
- \_ CCT selezionabile
- \_ Compatibile con scatola 506 (non inclusa)

- \_ Step light in polycarbonate with glass diffuser
- \_ Available with symmetric and asymmetric beam
- \_ Integrated 6W LED module
- \_ Selectable CCT
- \_ Compatible with 506 box (not included)



W	K	LUMEN APPARECCHIO lm	LUMEN SORGENTE lm		VARIANTE	CODICE	EAN		
6	<input type="checkbox"/> 3000 <input type="checkbox"/> 4000 <input type="checkbox"/> 6000	350	900	120°	SIMMETRICO / SYMMETRICAL	<b>ARONA602</b>	8031453034931	1/20	
6	<input type="checkbox"/> 3000 <input type="checkbox"/> 4000 <input type="checkbox"/> 6000	500	600	38°	ASIMMETRICO / ASYMMETRICAL	<b>ARONA603</b>	8031453034948	1/20	

## ARONA 1

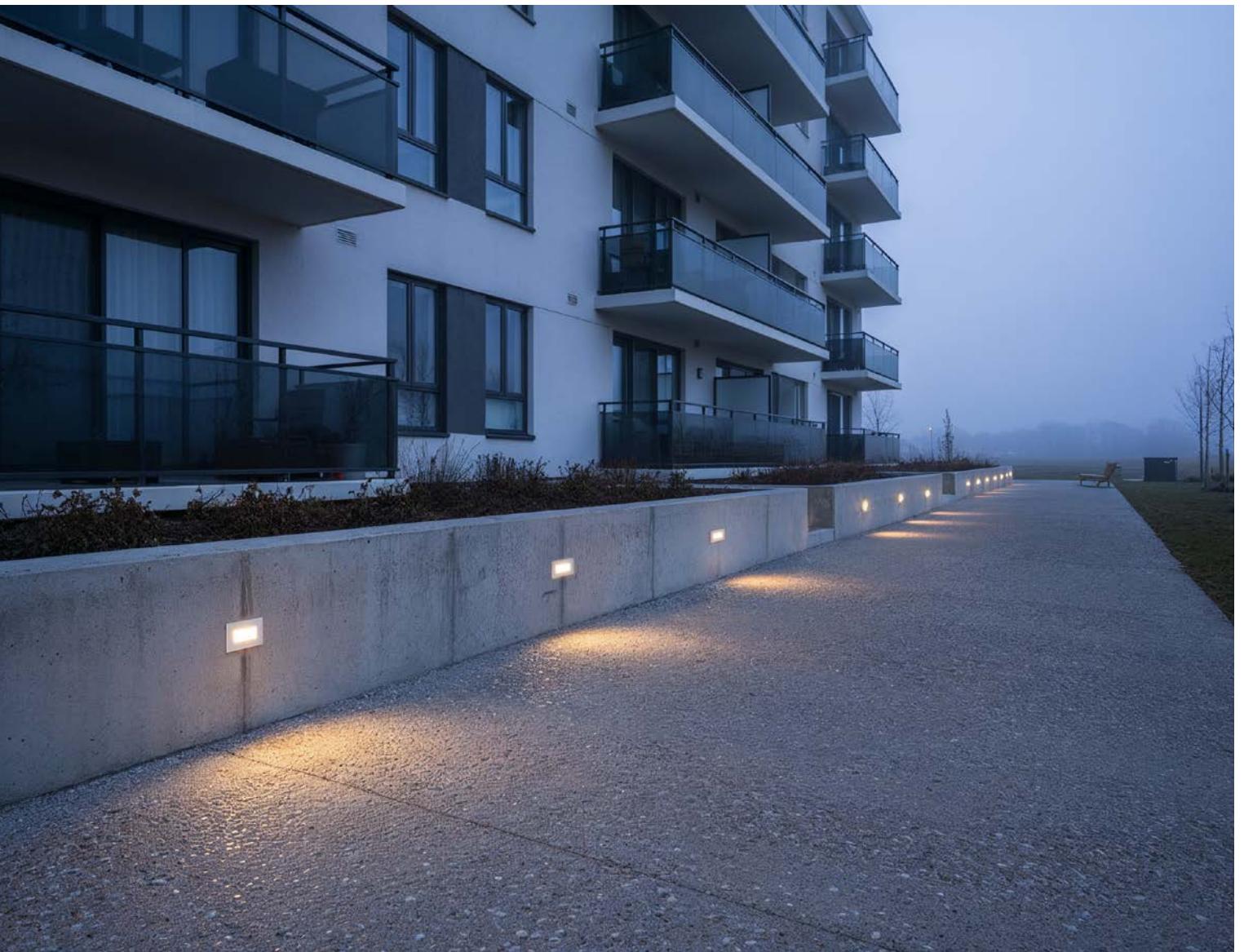

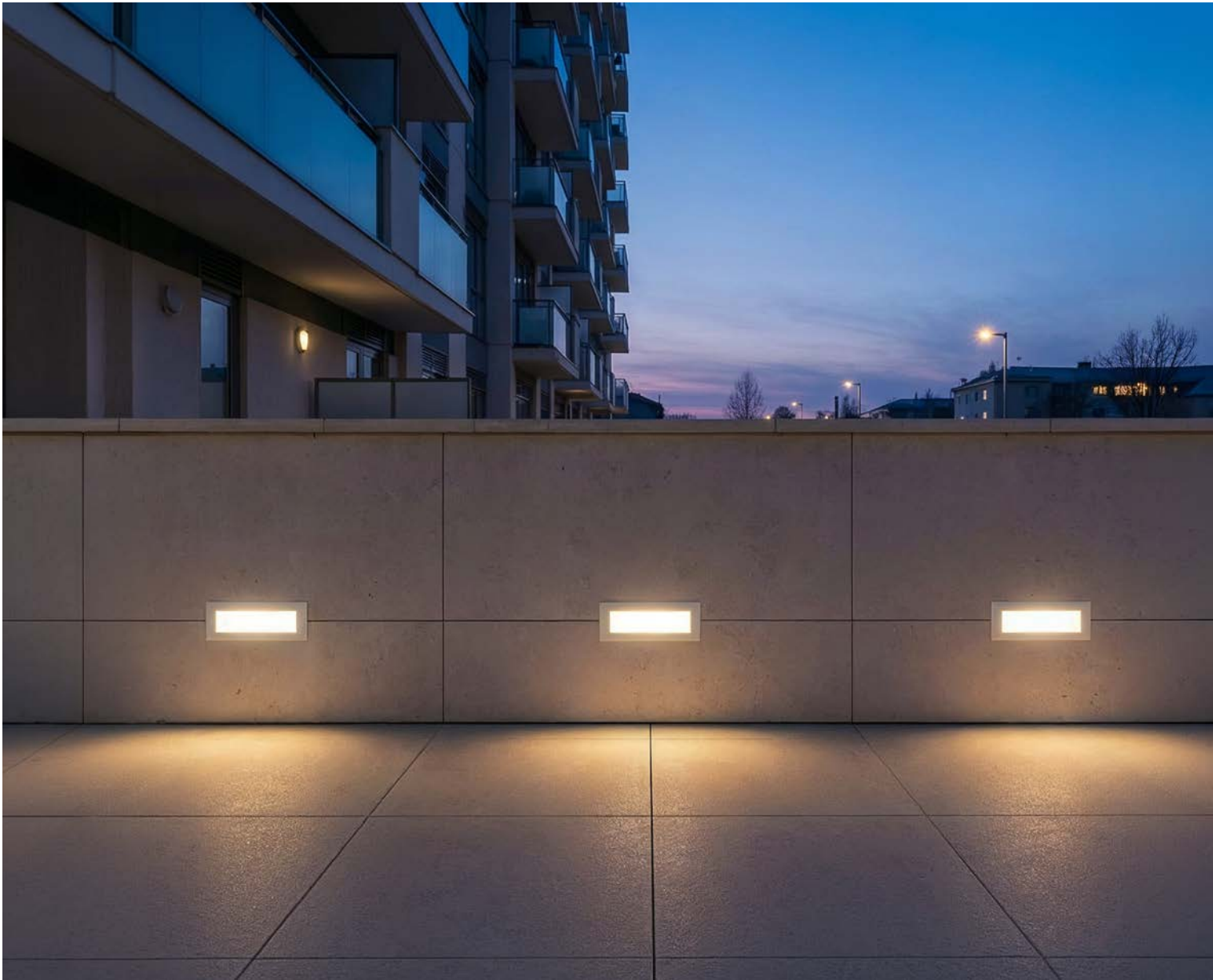

**ARONA 3**

# ARONA 200

BTL CATEGORIA SCONTO 24

Segnapasso CCT per cover magnetica / CCT step light for magnetic cover



Scatola tonda inclusa  
Round box included

- \_ Segnapasso in policarbonato e alluminio
  - \_ Cover magnetica in alluminio sostituibile ((da ordinare separatamente)
  - \_ Disponibile in 4 colori e 2 forme
  - \_ Modulo led integrato da 1,5W
  - \_ CCT selezionabile
  - \_ Compatibile con scatola tonda standard europeo (in dotazione)
- \_ Polycarbonate and aluminum steplight
  - \_ Replaceable magnetic aluminum cover (order separately)
  - \_ 4 colors and 2 shapes available
  - \_ Built-in 1.5W led module
  - \_ Selectable CCT
  - \_ Compatible with European round standard formwork (included)



W	K	LUMEN APPARECCHIO lm	LUMEN SORGENTE lm		VARIANTE	CODICE	EAN			
1,5	<input type="checkbox"/> 3000 <input type="checkbox"/> 4000 <input type="checkbox"/> 6000	80	100	38°	-	<b>ARONA200</b>	8031453029005	1		
						<input type="checkbox"/> COVER - OVALE BIANCO / WHITE OVAL	<b>ARONA200FOB</b>	8031453029050	1	
						<input type="checkbox"/> COVER - OVALE GRIGIO CHIARO / LIGHT GREY OVAL	<b>ARONA200FOG</b>	8031453029081	1	
						<input type="checkbox"/> COVER - OVALE GRIGIO SIDERALE / SPACE GRAY OVAL	<b>ARONA200FOA</b>	8031453029074	1	
						<input type="checkbox"/> COVER - OVALE NERO / BLACK OVAL	<b>ARONA200FON</b>	8031453029067	1	
ACCESSORI ACCESSORIES							<input type="checkbox"/> COVER - RETTANGOLARE BIANCO / WHITE RECTANGULAR	<b>ARONA200FRB</b>	8031453029012	1
						<input type="checkbox"/> COVER - RETTANGOLARE GRIGIO CHIARO / LIGHT GREY RECTANGULAR	<b>ARONA200FRG</b>	8031453029043	1	
						<input type="checkbox"/> COVER - RETTANGOLARE GRIGIO SIDERALE / SPACE GREY RECTANGULAR	<b>ARONA200FRA</b>	8031453029036	1	
						<input type="checkbox"/> COVER - RETTANGOLARE NERO / BLACK RECTANGULAR	<b>ARONA200FRN</b>	8031453029029	1	
						SCATOLA TONDA STANDARD EUROPEO / EUROPEAN STANDARD ROUND BOX	<b>ARONAB</b>	8031453029098	1	

# ARONA 300

BTL CATEGORIA SCONTO 24

Segnapasso CCT per cover magnetica / CCT step light for magnetic cover

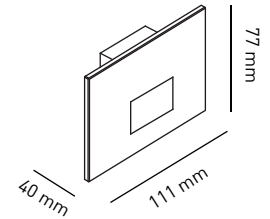
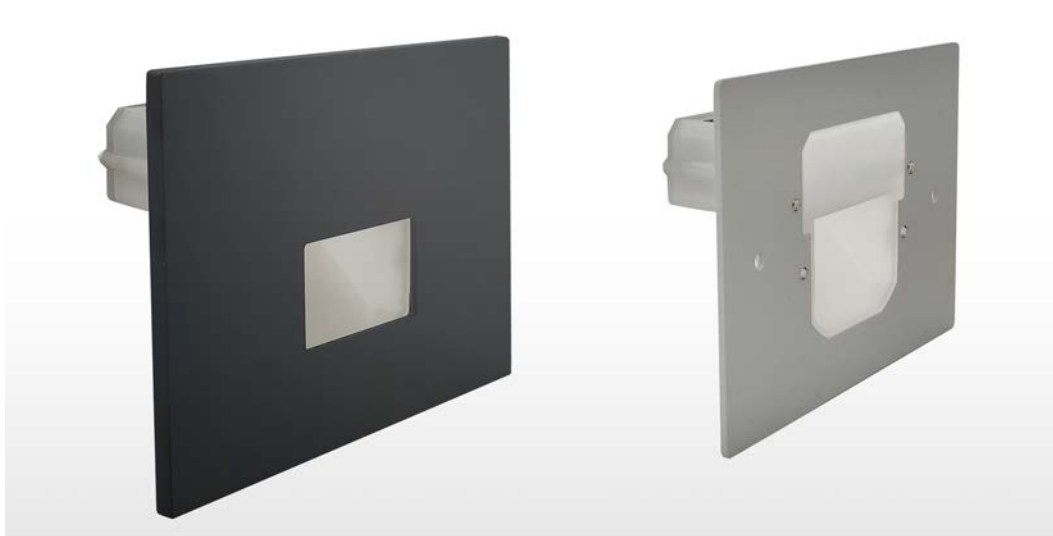

- \_ Segnapasso in policarbonato e alluminio
- \_ Cover magnetica in alluminio sostituibile (da ordinare separatamente)
- \_ Disponibile in 4 colori e 2 forme
- \_ Modulo led integrato da 1,5W
- \_ CCT selezionabile
- \_ Compatibile con scatola 503 (non inclusa)

- \_ Polycarbonate and aluminum steplight
- \_ Replaceable magnetic aluminum cover (order separately)
- \_ 4 colors and 2 shapes available
- \_ Built-in 1.5W led module
- \_ Selectable CCT
- \_ Compatible with 503 formwork (not included)



W	K	LUMEN APPARECCHIO lm	LUMEN SORGENTE lm		VARIANTE	CODICE	EAN		
1,5	3000	80	100	38°	-	ARONA300	8031453028916	1	
	4000								
	6000								
			COVER - OVALE BIANCO / WHITE OVAL			ARONA300FOB	8031453028961	1	
			COVER - OVALE GRIGIO CHIARO / LIGHT GREY OVAL			ARONA300FOG	8031453028992	1	
			COVER - OVALE GRIGIO SIDERALE / SPACE GRAY OVAL			ARONA300FOA	8031453028985	1	
			COVER - OVALE NERO / BLACK OVAL			ARONA300FON	8031453028978	1	
ACCESSORI ACCESSORIES			COVER - RETTANGOLARE BIANCO / WHITE RECTANGULAR			ARONA300FRB	8031453028923	1	
			COVER - RETTANGOLARE GRIGIO CHIARO / LIGHT GREY RECTANGULAR			ARONA300FRG	8031453028954	1	
			COVER - RETTANGOLARE GRIGIO SIDERALE / SPACE GREY RECTANGULAR			ARONA300FRA	8031453028947	1	
			COVER - RETTANGOLARE NERO / BLACK RECTANGULAR			ARONA300FRN	8031453028930	1	

**ARONA 200**





**ARONA 300**

# BILBAO 3 SQUARED

BTL CATEGORIA SCONTO 24

Segnapasso CCT / CCT step light

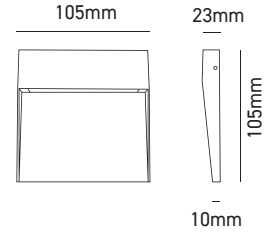

Segnapasso dal design elegante e discreto, illumina e sottolinea ogni percorso impreziosendo ambienti classici e moderni

*Step light with an elegant and understated design, illuminating and accentuating any pathway while enhancing both classic and modern settings*

- \_ Segnapasso quadrato in pressofusione di alluminio per applicazione a parete
- \_ Modulo LED integrato da 3W
- \_ CCT selezionabile

- \_ Square steplight in die-cast aluminum for wall application
- \_ Built-in 3W LED
- \_ Selectable CCT



W	K	LUMEN APPARECCHIO lm	LUMEN SORGENTE lm		VARIANTE	CODICE	EAN		
3	<input type="checkbox"/> 3000 <input type="checkbox"/> 4000 <input type="checkbox"/> 5000	145	335	64°	<input type="checkbox"/> BIANCO / WHITE	<b>BILBAO3BQ</b>	8031453022655	1/20	
3	<input type="checkbox"/> 3000 <input type="checkbox"/> 4000 <input type="checkbox"/> 5000	90	335	64°	<input checked="" type="checkbox"/> ANTRACITE / ANTHRACITE	<b>BILBAO3GQ</b>	8031453022662	1/20	
3	<input type="checkbox"/> 3000 <input type="checkbox"/> 4000 <input type="checkbox"/> 5000	100	335	64°	<input checked="" type="checkbox"/> GRIGIO MARINA / LIGHT GREY	<b>BILBAO3MQ</b>	8031453022679	1/20	
3	<input type="checkbox"/> 3000 <input type="checkbox"/> 4000 <input type="checkbox"/> 5000	100	335	64°	<input checked="" type="checkbox"/> CORTEN	<b>BILBAO3CQ</b>	8031453032852	1/20	

# BILBAO 6 SQUARED

BTL CATEGORIA SCONTO 24

Segnapasso CCT / CCT step light

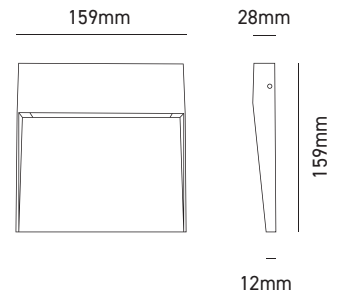

Segnapasso dal design elegante e discreto, illumina e sottolinea ogni percorso impreziosendo ambienti classici e moderni

Step light with an elegant and understated design, illuminating and accentuating any pathway while enhancing both classic and modern settings

- \_ Segnapasso quadrato in pressofusione di alluminio per applicazione a parete
- \_ Modulo LED integrato da 6,5W
- \_ CCT selezionabile

- \_ Square steplight in die-cast aluminum for wall application
- \_ Built-in 6,5W LED module
- \_ Selectable CCT



W	K	LUMEN APPARECCHIO lm	LUMEN SORGENTE lm		VARIANTE	CODICE	EAN		
6,5	<input type="checkbox"/> 3000 <input type="checkbox"/> 4000 <input type="checkbox"/> 5000	300	675	72°	<input type="checkbox"/> BIANCO / WHITE	<b>BILBAO6BQ</b>	8031453032869	1/20	
6,5	<input type="checkbox"/> 3000 <input type="checkbox"/> 4000 <input type="checkbox"/> 5000	255	675	72°	<input checked="" type="checkbox"/> ANTRACITE / ANTHRACITE	<b>BILBAO6GQ</b>	8031453022723	1/20	
6,5	<input type="checkbox"/> 3000 <input type="checkbox"/> 4000 <input type="checkbox"/> 5000	305	675	72°	<input checked="" type="checkbox"/> GRIGIO MARINA / LIGHT GREY	<b>BILBAO6MQ</b>	8031453022730	1/20	
6,5	<input type="checkbox"/> 3000 <input type="checkbox"/> 4000 <input type="checkbox"/> 5000	290	675	72°	<input checked="" type="checkbox"/> CORTEN	<b>BILBAO6CQ</b>	8031453022716	1/20	

# SORIA RETTANGOLARE

BTL CATEGORIA SCONTO 24

Segnapasso CCT / CCT step light

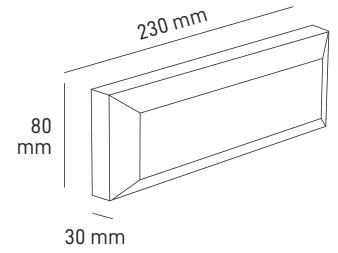

- \_ Segnapasso in ABS e policarbonato per applicazione a parete
- \_ Cover bianca e antracite in dotazione
- \_ Disponibile con fascio simmetrico e asimmetrico
- \_ Modulo LED integrato da 4W
- \_ CCT selezionabile

- \_ Steplight in ABS and polycarbonate for wall application
- \_ White and anthracite cover supplied
- \_ Available with symmetrical and asymmetrical beam
- \_ Built-in 4W LED module
- \_ Selectable CCT



W	K	LUMEN APPARECCHIO lm	LUMEN SORGENTE lm		VARIANTE	CODICE	EAN		
4	<input type="checkbox"/> 3000 <input type="checkbox"/> 4000 <input type="checkbox"/> 6500	390	440	120°	SIMMETRICO / SYMMETRICAL	<b>SORIA4</b>	8031453027438	1/20	
4	<input type="checkbox"/> 3000 <input type="checkbox"/> 4000 <input type="checkbox"/> 6500	300	440	38°	ASIMMETRICO / ASYMMETRICAL	<b>SORIA4A</b>	8031453027445	1/20	

# SORIA QUADRATO

BTL CATEGORIA SCONTO 24

Segnapasso CCT / CCT step light

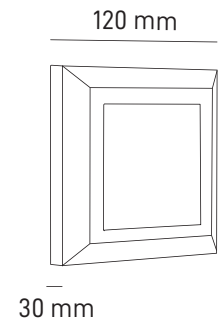

- \_ Segnapasso in ABS e policarbonato per applicazione a parete
- \_ Cover bianca e antracite in dotazione
- \_ Modulo LED integrato da 4W
- \_ CCT selezionabile

- \_ Steplight in ABS and polycarbonate for wall application
- \_ White and anthracite cover supplied
- \_ Built-in 4W LED module
- \_ Selectable CCT



W	K	LUMEN APPARECCHIO lm	LUMEN SORGENTE lm		VARIANTE	CODICE	EAN		
4	<div style="display: flex; gap: 5px;"> <div style="width: 15px; height: 15px; background-color: #FFD700; border: 1px solid black;"></div> 3000  <div style="width: 15px; height: 15px; background-color: #FFFFFF; border: 1px solid black;"></div> 4000  <div style="width: 15px; height: 15px; background-color: #ADD8E6; border: 1px solid black;"></div> 6500                 </div>	330	450	120°	-	SORIA4Q	8031453027452	1/20	

# AITONA QUADRATO

BTL CATEGORIA SCONTO 24

Segnapasso calpestabile / Walk-over step light

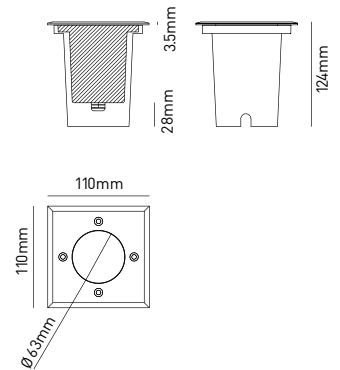

GU10 ALTA  
TEMPERATURA  
P. 98



- \_ Segnapasso calpestabile per esterno
- \_ Attacco GU10 per sorgenti LED max 7W (modello suggerito GU10 alta temperatura)
- \_ Controcassa di installazione inclusa
- \_ Doppio pressacavo per collegamento in-out

- \_ *Walk-over outdoor step light*
- \_ *GU10 socket for max 7W LED sources (high-temperature GU10 model suggested)*
- \_ *Installation back box included*
- \_ *Double cable gland for in-out connection*



W	BASE		VARIANTE	CODICE	EAN	
-	GU10	-	QUADRATO / SQUARED	AITONA7Q	8031453030766	1/20

# AITONA ROTONDO

NEW

BTL CATEGORIA SCONTO 24

Segnapasso carrabile / Drive-over step light

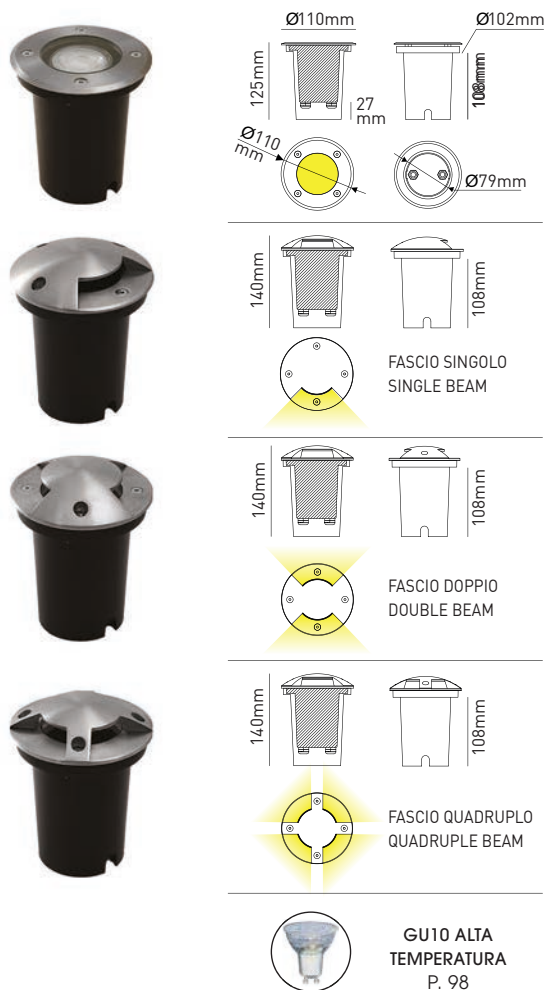

- \_ Segnapasso carrabile per esterno
- \_ Disponibile in 4 versioni differenti
- \_ Ghiera e viti in acciaio inox spazzolato
- \_ Attacco GU10 per sorgenti LED max 7W (modello suggerito GU10 alta temperatura)
- \_ Controcassa di installazione inclusa
- \_ Doppio pressacavo per collegamento in-out

- \_ Drive-over outdoor step light
- \_ Available in 4 different versions
- \_ Brushed stainless steel ring and screws
- \_ GU10 socket for max 7W LED sources (high-temperature GU10 model suggested)
- \_ Installation back box included
- \_ Double cable gland for in-out connection



W	BASE		VARIANTE	CODICE	EAN	
-	GU10	-	ROTONDO / ROUNDED	<b>AITONA7R</b>	8031453030759	1/20
-	GU10	-	ROTONDO - FASCIO SINGOLO / ROUNDED - SINGLE BEAM	<b>AITONA7R1</b>	8031453035075	1/20
-	GU10	-	ROTONDO - FASCIO DOPPIO / ROUNDED - DOUBLE BEAM	<b>AITONA7R2</b>	8031453035082	1/20
-	GU10	-	ROTONDO - FASCIO QUADRUPLO / ROUNDED - QUADRUPLE BEAM	<b>AITONA7R4</b>	8031453035099	1/20





**TECNICO / LAMPADE SOLARI IBRIDE**  
TECHNICAL / HYBRID SOLAR LAMPS

## LAMPADE SOLARI IBRIDE

Le lampade solari ibride per esterni combinano energia solare e alimentazione da rete per offrire un'illuminazione continua, efficiente e affidabile. Il sistema sfrutta prioritariamente l'energia prodotta dal pannello solare e, quando questa non è sufficiente, passa automaticamente alla rete elettrica, garantendo sempre continuità di funzionamento.

Questa soluzione è ideale per chi desidera ridurre i consumi senza rinunciare alla sicurezza e alla stabilità dell'impianto. Grazie a una gestione intelligente dell'alimentazione e a funzioni dedicate all'uso outdoor, le lampade ibride rappresentano una scelta pratica e moderna per parcheggi, percorsi, aree residenziali e spazi pubblici.

### VANTAGGI DEI PRODOTTI BOT LIGHTING HYBRID

- Alimentazione ibrida: pannello solare + rete elettrica
- Passaggio automatico alla rete quando necessario
- Illuminazione continua e affidabile
- Ottimizzazione dei consumi energetici
- Sensore crepuscolare per accensione automatica
- Rilevatore di presenza per una gestione più efficiente della luce
- Batteria integrata per l'accumulo dell'energia
- Ideali per applicazioni esterne civili e professionali

## HYBRID SOLAR LAMPS

*Hybrid outdoor lighting combines solar energy with mains power to deliver continuous, efficient and reliable illumination. The system gives priority to the energy generated by the solar panel and, whenever this is not sufficient, automatically switches to mains supply to ensure uninterrupted operation.*

*This solution is ideal for those looking to reduce energy consumption without compromising safety, performance or lighting continuity. Thanks to smart power management and features designed for outdoor applications, hybrid lighting is a practical and modern choice for car parks, pathways, residential areas and public spaces.*

### BOT LIGHTING SOLAR HYBRID ADVANTAGES

- Hybrid power supply: solar panel + mains power
- Automatic switch to mains when needed
- Continuous and reliable lighting
- Optimised energy consumption
- Dusk sensor for automatic switching on
- Motion sensor for more efficient light management
- Integrated battery for energy storage
- Ideal for civil and professional outdoor applications



**SHOT**  
BOT LIGHTING

solar hybrid



# KALAP IBRIDO

NEW

BTL CATEGORIA SCONTO 24

Testa-palo solare ibrido / Hybrid solar post-top

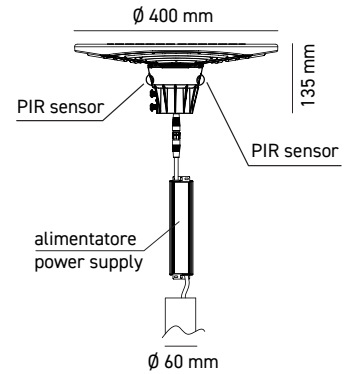

TUTTI I SETTORI SONO ATTIVABILI SOLO SIMULTANEAMENTE

ALL SECTORS CAN ONLY BE ACTIVATED SIMULTANEOUSLY



- \_ Testa-palo (Ø60 mm) con sensore crepuscolare e rilevatore di presenza PIR
- \_ Tecnologia ibrida per combinare risparmio energetico e continuità luminosa
- \_ Ricarica esclusivamente solare: l'alimentazione di rete non ricarica la batteria, ma interviene solo come supporto durante la notte
- \_ Batteria alta qualità LiFePO4 32700, 6,4V, 6000mAh, 38.4Wh
- \_ Pannello solare 12Wp
- \_ Tempo di ricarica solare: 6 ore
- \_ Materiale ABS + PC anti UV, autoestinguento
- \_ 2 modalità di funzionamento selezionabili e customizzabili tramite telecomando
- \_ CCT selezionabile
- \_ Telecomando incluso

- \_ Post-top (Ø60 mm) with dusk sensor and PIR motion detector
- \_ Hybrid technology to combine energy savings and reliability
- \_ Solar charging only: mains power does not recharge the battery, but is used only as support during the night
- \_ High-quality LiFePO4 32700 battery, 6.4V, 6000mAh, 38.4Wh
- \_ 12Wp solar panel
- \_ Solar charging time: 6 hours
- \_ Self-extinguishing ABS + PC anti UV material
- \_ 2 selectable and customizable operating modes via the remote control
- \_ Selectable CCT
- \_ Remote control included



W	K	LUMEN APPARECCHIO lm		VARIANTE	CODICE	EAN	
---	---	----------------------	--	----------	--------	-----	--

30	<input type="checkbox"/> 3000 <input checked="" type="checkbox"/> 4000 <input type="checkbox"/> 6500	4800	140°	-	KALAP48HY	8031453034818	1/3
----	--	------	------	---	-----------	---------------	-----

Batteria LiFePO4 32700 2 celle 6,4V 6000mAh per KALAP4800NK, KALAP48HY e YUMA4800NK **B222064060A** 8031453033620 1



## KALAP HYBRID

### FUNZIONAMENTO

L'apparecchio utilizza l'energia immagazzinata dalla batteria durante il giorno per poi passare all'alimentazione della rete elettrica solo quando la batteria scende sotto il 7% di capacità. Il testa-palo ha due modalità di funzionamento, personalizzabili con il telecomando.

**MODALITÀ SENSORE:** l'apparecchio si accende automaticamente al tramonto al 10% di emissione luminosa. Quando viene rilevato movimento nel raggio di rilevamento dei sensori l'emissione luminosa passa al 100%, per poi tornare al 10% se per 20 secondi non viene rilevato alcun movimento. L'apparecchio si spegnerà al sorgere del sole.

**MODALITÀ LUCE COSTANTE:** l'apparecchio si accenderà al tramonto secondo le impostazioni di default: 60% di emissione luminosa costante per 3 ore. Dopo le 3 ore l'apparecchio passerà in MODALITÀ SENSORE. È possibile personalizzare i valori di emissione luminosa e durata del funzionamento in MODALITÀ LUCE COSTANTE tramite il telecomando.

### OPERATION

The device uses the energy stored in the battery during the day and switches to mains power only when the battery capacity drops below 7%. The post-top has two operating modes, customizable with the remote control.

**SENSOR MODE:** The device automatically turns on at sunset at 10% brightness. When motion is detected within the sensor's detection range, the brightness increases to 100%, then returns to 10% if no motion is detected for 20 seconds. The device will turn off at sunrise.

**CONSTANT LIGHT MODE:** The device will turn on at sunset according to the default settings: 60% constant brightness for 3 hours. After 3 hours, the device will switch to SENSOR MODE. It is possible to customize the brightness level and operating duration in CONSTANT LIGHT MODE using the remote control.

# YUMA63HY IBRIDO

NEW

BTL CATEGORIA SCONTO 24

Proiettore solare stradale ibrido / Hybrid street solar floodlight

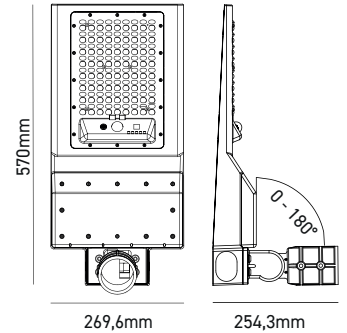

VARIAZIONE FASCIO LUMINOSO  
LIGHT BEAM VARIATION

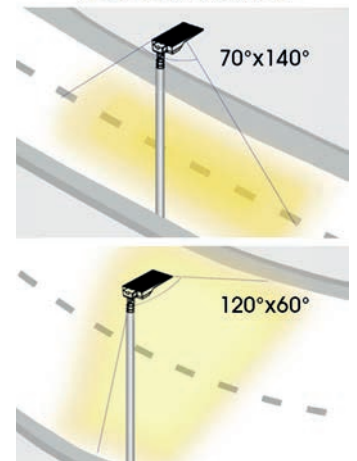

- \_ Proiettore con sensore crepuscolare e rilevatore di presenza PIR
- \_ Tecnologia ibrida per combinare risparmio energetico e continuità luminosa
- \_ Ricarica esclusivamente solare: l'alimentazione di rete non ricarica la batteria, ma interviene solo come supporto durante la notte
- \_ Dotato di ottica doppia con fascio selezionabile tra 70x140° e 120x60° mediante telecomando
- \_ Innesto per palo (Ø50-60mm) orientabile 0-90°
- \_ Batteria alta qualità LiFePO4 32700, 9.6V, 12000mAh, 115.2Wh
- \_ Pannello solare 21Wp
- \_ Tempo di ricarica: 8 ore
- \_ Materiale ABS + PC anti UV, autoestinguente
- \_ 2 modalità di funzionamento selezionabili e customizzabili tramite telecomando
- \_ CCT selezionabile
- \_ Telecomando incluso

- \_ Floodlight with twilight sensor and PIR presence detector
- \_ Hybrid technology to combine energy saving and lighting continuity
- \_ Solar charging only: mains power does not recharge the battery, but is used only as support during the night
- \_ Equipped with double optics with selectable beam between 70x140° and 120x60° via remote control
- \_ Pole mount (Ø50-60mm) adjustable 0-90°
- \_ High-quality LiFePO4 32700 battery, 9.6V, 12000mAh, 115.2Wh
- \_ 21Wp solar panel
- \_ Charging time: 8 hours
- \_ ABS + UV-resistant, self-extinguishing PC material
- \_ 2 selectable and customizable operating modes via remote control
- \_ Selectable CCT
- \_ Remote control included



W	K	LUMEN APPARECCHIO lm		VARIANTE	CODICE	EAN	
40	<input type="checkbox"/> 3000 <input type="checkbox"/> 4000 <input type="checkbox"/> 6500	6300	<input type="checkbox"/> 70x140° <input type="checkbox"/> 120x60°	-	YUMA63HY	8031453034917	1/2

Batteria LiFePO4 32700 6 celle 9,6V 12000mAh per YUMA40NK e YUMA63HY

B226096012A

8031453033651

1



## YUMA63HY HYBRID



### FUNZIONAMENTO

L'apparecchio utilizza l'energia immagazzinata dalla batteria durante il giorno per poi passare all'alimentazione della rete elettrica solo quando la batteria scende sotto il 5% di capacità. Il proiettore ha due modalità di funzionamento, personalizzabili con il telecomando.

**MODALITÀ SENSORE:** l'apparecchio si accende automaticamente al tramonto al 15% di emissione luminosa. Quando viene rilevato movimento nel raggio di rilevamento del sensore, l'emissione luminosa aumenta automaticamente tra il 50% e il 100% in base alla carica residua della batteria grazie al sistema intelligente dell'apparecchio, per poi tornare al 15% dopo 20 secondi di inattività. L'apparecchio si spegnerà al sorgere del sole.

**MODALITÀ LUCE COSTANTE:** l'apparecchio si accenderà al tramonto secondo le impostazioni di default: 60% di emissione luminosa costante per 3 ore. Dopo le 3 ore l'apparecchio passerà in MODALITÀ SENSORE. È possibile personalizzare i valori di emissione luminosa e durata del funzionamento in MODALITÀ LUCE COSTANTE tramite il telecomando.

### OPERATION

The device uses the energy stored in the battery during the day and switches to mains power only when the battery capacity drops below 5%.

The projector has two operating modes, customizable with the remote control.

**SENSOR MODE:** The device automatically turns on at sunset at 15% brightness. When the sensor detects movement in its range, the light will automatically increase between 50% and 100% depending on the battery charge, thanks to the device's smart system. After 20 seconds without movement, the light goes back to 15%. The device will turn off at sunrise.

**CONSTANT LIGHT MODE:** The device will turn on at sunset according to the default settings: 60% constant brightness for 3 hours. After 3 hours, the device will switch to SENSOR MODE. It is possible to customize the brightness level and operating duration in CONSTANT LIGHT MODE using the remote control.





**SHOT**  
BOT LIGHTING

**TECNICO / LAMPADE SOLARI**  
TECHNICAL / SOLAR LAMPS

# KALAP

BTL CATEGORIA SCONTO 24

Testa-palo solare / Solar post-top

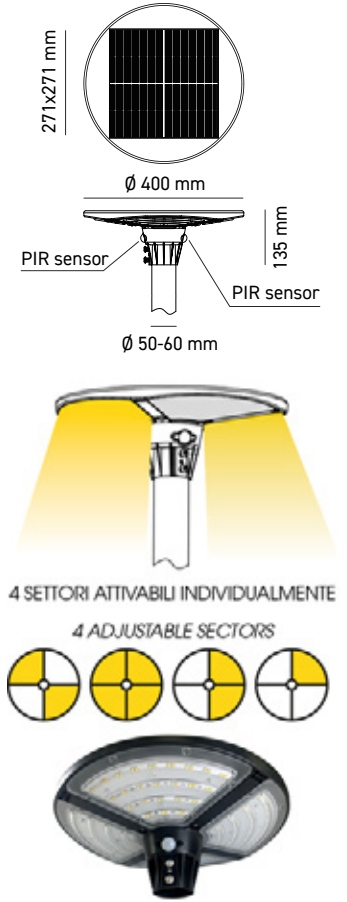

Lampione solare professionale ad alta potenza e lunga durata. Adatto a molteplici applicazioni in ambito residenziale (viali, parcheggi, giardini), anche in sostituzione ai lampioni pre-esistenti. Grazie ai 4 settori indipendenti è possibile personalizzare l'area illuminata e regolare la potenza assorbita dall'apparecchio.

Professional high-power solar streetlight with long lifespan. Suitable for multiple applications in residential areas (driveways, parking lots, gardens), also as a replacement for pre-existing streetlights. Thanks to the 4 independent sectors, it is possible to customize the illuminated area and adjust the device's power consumption.

- \_ Testa-palo (Ø50-60 mm) con sensore crepuscolare e rilevatore di presenza PIR
- \_ Facile installazione: non richiede collegamenti alla rete elettrica
- \_ Batteria alta qualità LiFePO4 32700, 6,4V, 6000mAh, 38.4Wh
- \_ Pannello solare 12Wp
- \_ Tempo di ricarica: 6 ore
- \_ Materiale ABS + PC anti UV , autoestinguento
- \_ 4 settori attivabili singolarmente
- \_ 2 modalità di funzionamento selezionabili e customizzabili tramite telecomando
- \_ CCT selezionabile
- \_ Telecomando incluso

- \_ Post-top (Ø50-60 mm) with dusk sensor and PIR motion detector
- \_ Easy installation: mains connection not needed
- \_ High-quality LiFePO4 32700 battery, 6.4V, 6000mAh, 38.4Wh
- \_ 12Wp solar panel
- \_ Charging time: 6 hours
- \_ Self-extinguishing ABS + PC anti UV material
- \_ 4 sectors that can be activated individually
- \_ 2 selectable and customizable operating modes via the remote control
- \_ Selectable CCT
- \_ Remote control included



W	K	LUMEN APPARECCHIO lm		VARIANTE	CODICE	EAN	
30	<input checked="" type="checkbox"/> 3000 <input type="checkbox"/> 4000 <input type="checkbox"/> 6500	4800	140°	-	<b>KALAP4800NK</b>	8031453033422	1/3
Batteria LiFePO4 32700 2 celle 6,4V 6000mAh per KALAP4800NK, KALAP48HY e YUMA4800NK					<b>B222064060A</b>	8031453033620	1



#### **FUNZIONAMENTO**

Il testa-palo ha due modalità di funzionamento, personalizzabili con il telecomando.

**MODALITÀ SENSORE:** l'apparecchio si accende automaticamente al tramonto al 10% di emissione luminosa. Quando viene rilevato movimento nel raggio di rilevamento dei sensori l'emissione luminosa passa al 100%, per poi tornare al 10% se per 20 secondi non viene rilevato alcun movimento. L'apparecchio si spegnerà al sorgere del sole o quando la batteria sarà completamente scarica.

**MODALITÀ LUCE COSTANTE:** l'apparecchio si accenderà al tramonto secondo le impostazioni di default: 60% di emissione luminosa costante per 3 ore. Dopo le 3 ore l'apparecchio passerà in MODALITÀ SENSORE. È possibile personalizzare i valori di emissione luminosa e durata del funzionamento in MODALITÀ LUCE COSTANTE tramite il telecomando.

#### **OPERATION**

The post-top has two operating modes, customizable with the remote control.

**SENSOR MODE:** The device automatically turns on at sunset at 10% brightness. When motion is detected within the sensor's detection range, the brightness increases to 100%, then returns to 10% if no motion is detected for 20 seconds. The device will turn off at sunrise or when the battery is completely discharged.

**CONSTANT LIGHT MODE:** The device will turn on at sunset according to the default settings: 60% constant brightness for 3 hours. After 3 hours, the device will switch to SENSOR MODE. It is possible to customize the brightness level and operating duration in CONSTANT LIGHT MODE using the remote control.

# YUMA6NK

## Proiettore solare / Solar floodlight



REGOLABILE / ADJUSTABLE

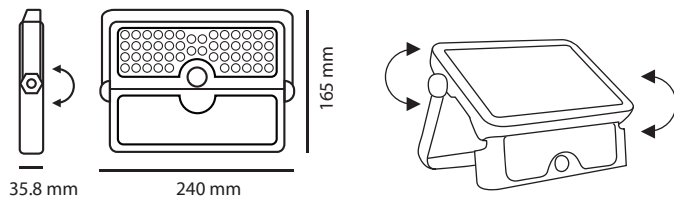

- \_ Proiettore con sensore crepuscolare e rilevatore di presenza PIR
- \_ Facile Installazione: non richiede collegamenti alla rete elettrica
- \_ Batteria Li-ION 18650, 3.7V, 3000mAh, 11.1Wh
- \_ Pannello solare 2,3Wp
- \_ Tempo di ricarica: 6 ore
- \_ Materiale ABS + PC anti UV , autoestinguente
- \_ CCT selezionabile

### FUNZIONAMENTO

- TASTO ON/OFF (1): Premere una volta il tasto per accendere il proiettore. Premerlo nuovamente per cambiare il colore della luce. In questa modalità l'apparecchio rimarrà acceso al 30% fino all'esaurimento della batteria o al sorgere del sole. Tenerlo premuto per 3sec per spegnere l'apparecchio.
- TASTO SENSOR MODE (2): In questa modalità il proiettore si accende al rilevamento del movimento con emissione luminosa del 100% se la luce ambientale rilevata tramite il pannello è al di sotto dei 40lux circa. Se non viene rilevato movimento per 30 secondi la luce si spegne.
- TASTO ALL NIGHT MODE (3): Fino a quando la luminosità ambientale rilevata è inferiore a circa 40lux il pannello rimane acceso al 10% di emissione luminosa, fino alla scarica della batteria o al sorgere del sole.
- TASTO LOW LIGHT SENSOR MODE (4): In questa modalità il proiettore si accende al rilevamento del movimento con il 100% di emissione. Se non viene rilevato movimento per 30 secondi, il proiettore passerà al 10% di emissione fino al movimento rilevato successivo.

### OPERATION

- ON/OFF KEY (1): Press the button once, to turn on the projector. Press it again to change the color of the light. In this mode, the appliance will remain on at 30% until the battery runs out or the sun rises. Press and hold more than 3 sec to turn off the appliance.
- SENSOR MODE KEY (2): In this mode the projector will turn on, when motion is detected, at 100% light output. If the ambient light detected through the panel is below 40lux. If no motion is detected for 30 seconds, the light will turn off.
- ALL NIGHT MODE KEY (3): As long as the ambient brightness detected is less than about 40lux, the panel remains on at 10% light output until the battery is discharged or the sun rises.
- LOW LIGHT SENSOR MODE KEY (4): In this mode the projector will turn, when motion is detected, at 100% output. If no motion is detected for 30 seconds, the projector will switch to 10% output until the next motion detected.

- \_ Floodlight with dusk sensor and PIR presence detector
- \_ Easy to install: does not require connection to mains energy
- \_ Li-ION 18650 battery 3.7V, 3000mAh, 11.1Wh
- \_ 2,3Wp solar panel
- \_ Charging time: 6 hours
- \_ Material ABS + PC anti UV, self-extinguishing
- \_ Selectable CCT



W	K	LUMEN APPARECCHIO lm		VARIANTE	CODICE	EAN	
6	<input type="checkbox"/> 3000 <input type="checkbox"/> 4000 <input type="checkbox"/> 6000	600	120°	-	YUMA6NK	8031453030902	1/10
Batteria Li-ION 18650 1 cella 3,7V 3000mAh per YUMA6NK					B111037030Z	8031453033521	1

# YUMA10NK

Proiettore solare / Solar floodlight



REGOLABILE / ADJUSTABLE

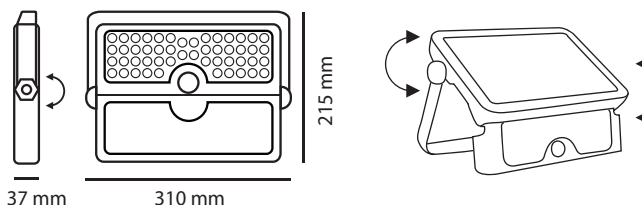

- \_ Proiettore con sensore crepuscolare e rilevatore di presenza PIR
- \_ Facile Installazione: non richiede collegamenti alla rete elettrica
- \_ 2 batterie Li-ION 18650, 3.7V, 3300mAh, 24.42Wh
- \_ Pannello solare 6Wp
- \_ Tempo di ricarica: 8 ore
- \_ Materiale ABS + PC anti UV , autoestinguento
- \_ CCT selezionabile

## FUNZIONAMENTO

**TASTO ON/OFF (1):** Premere una volta il tasto per accendere il proiettore. Premerlo nuovamente per cambiare il colore della luce. In questa modalità l'apparecchio rimarrà acceso al 30% fino all'esaurimento della batteria o al sorgere del sole. Tenerlo premuto per 3sec per spegnere l'apparecchio.

**TASTO SENSOR MODE (2):** In questa modalità il proiettore si accende al rilevamento del movimento con emissione luminosa del 100% se la luce ambientale rilevata tramite il pannello è al di sotto dei 40lux circa. Se non viene rilevato movimento per 30 secondi la luce si spegne.

**TASTO ALL NIGHT MODE (3):** Fino a quando la luminosità ambientale rilevata è inferiore a circa 40lux il pannello rimane acceso al 10% di emissione luminosa, fino alla scarica della batteria o al sorgere del sole.

**TASTO LOW LIGHT SENSOR MODE (4):** In questa modalità il proiettore si accende al rilevamento del movimento con il 100% di emissione. Se non viene rilevato movimento per 30 secondi, il proiettore passerà al 10% di emissione fino al movimento rilevato successivo.

## OPERATION

**ON/OFF KEY (1):** Press the button once, to turn on the projector. Press it again to change the color of the light. In this mode, the appliance will remain on at 30% until the battery runs out or the sun rises. Press and hold more than 3 sec to turn off the appliance.

**SENSOR MODE KEY (2):** In this mode the projector will turn on, when motion is detected, at 100% light output. If the ambient light detected through the panel is below 40lux. If no motion is detected for 30 seconds, the light will turn off.

**ALL NIGHT MODE KEY (3):** As long as the ambient brightness detected is less than about 40lux, the panel remains on at 10% light output until the battery is discharged or the sun rises.

**LOW LIGHT SENSOR MODE KEY (4):** In this mode the projector will turn, when motion is detected, at 100% output. If no motion is detected for 30 seconds, the projector will switch to 10% output until the next motion detected.

- \_ Floodlight with dusk sensor and PIR presence detector
- \_ Easy to install: does not require connection to mains energy
- \_ 2x Li-ION 18650 battery, 3.7V, 3300mAh, 24.42Wh
- \_ 6Wp solar panel
- \_ Charging time: 8 hours
- \_ Material ABS + PC anti UV, self-extinguishing
- \_ Selectable CCT



W	K	LUMEN APPARECCHIO lm		VARIANTE	CODICE	EAN	
---	---	----------------------	--	----------	--------	-----	--

10	<ul style="list-style-type: none"> <li><span style="display: inline-block; width: 10px; height: 10px; background-color: yellow; border: 1px solid black; margin-right: 5px;"></span> 3000</li> <li><span style="display: inline-block; width: 10px; height: 10px; background-color: white; border: 1px solid black; margin-right: 5px;"></span> 4000</li> <li><span style="display: inline-block; width: 10px; height: 10px; background-color: lightblue; border: 1px solid black; margin-right: 5px;"></span> 6000</li> </ul>	1100	120°	-	YUMA10NK	8031453030919	1/8
----	--	------	------	---	----------	---------------	-----

Batteria Li-ION 18650 1 cella 3.7V 3300mAh per YUMA10NK (necessari 2 pezzi)				B111037033Z	8031453033538	1
---	--	--	--	-------------	---------------	---

# YUMA1500NK

BTL CATEGORIA SCONTO 24

Proiettore solare con pannello separato / Solar floodlight with separate panel

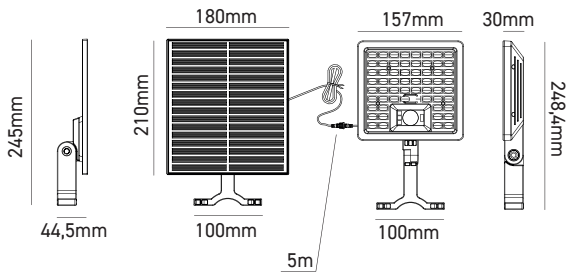

Il proiettore solare perfetto per illuminare spazi esterni senza bisogno di corrente elettrica. Con pannello separato, sensore crepuscolare e telecomando, garantisce praticità e versatilità per ogni impiego.

**FUNZIONAMENTO**

Il proiettore ha due modalità di funzionamento, personalizzabili con il telecomando.

**MODALITÀ SENSORE:** il proiettore si accende automaticamente di notte, al 100% dell'emissione quando viene rilevato un movimento nell'intervallo <8-10m, quindi passa al 5% di emissione luminosa 20 secondi dopo aver rilevato l'ultimo movimento.

**MODALITÀ LUCE COSTANTE:** il proiettore si accende automaticamente di notte e rimane acceso per il tempo e l'emissione luminosa selezionati (3h-5h-8h-12h / 20%-40%-60%)

**OPERATION**

The projector features two operating modes, customizable via the remote control.

**SENSOR MODE:** The projector automatically turns on at night, emitting 100% brightness when motion is detected within a range of <8-10m, then switches to 5% brightness 20 seconds after the last motion is detected.

**CONSTANT LIGHT MODE:** The projector automatically turns on at night and remains on for the selected duration and brightness level (3h-5h-8h-12h / 20%-40%-60%)

- Proiettore con sensore crepuscolare e rilevatore di presenza PIR
- Facile installazione: non richiede collegamenti alla rete elettrica
- Batteria alta qualità Li-ION 18650, 3.7V, 3600mAh, 13.32Wh
- Il proiettore può essere separato dal pannello ed utilizzato in modalità standalone
- Pannello solare 4,7Wp
- Tempo di ricarica: 4 ore
- Fascio asimmetrico 120° x 60° ampia area di illuminazione
- Materiale ABS + PC anti UV, autoestinguento
- Cavo di connessione di 5m con connettore IP67
- 2 modalità di funzionamento selezionabili e customizzabili tramite il telecomando incluso
- CCT selezionabile

The perfect solar projector for lighting outdoor spaces without the need for electricity. With a separate panel, twilight sensor, and remote control, it ensures practicality and versatility for any use.

- Floodlight with dusk sensor and PIR presence detector
- Easy installation: mains connection not needed
- High quality Li-ION 18650 battery, 3.7V, 3600mAh, 13.32Wh
- Floodlight can be separated from the solar panel for standalone use
- 4,7Wp solar panel
- Charging time: 4 hours
- Wide illumination area, 120° x 60° asymmetric beam angle
- Self-extinguishing ABS + PC anti UV material
- IP67 connector, 5m cable
- 2 selectable and customizable operating modes via the included remote controller
- Selectable CCT



W	K	LUMEN APPARECCHIO lm		VARIANTE	CODICE	EAN	
10	<input type="checkbox"/> 3000 <input type="checkbox"/> 4000 <input type="checkbox"/> 6500	1500	60X120°	-	YUMA1500NK	8031453032685	1/16

Batteria Li-ION 18650 2 celle 3,7V 3600mAh per YUMA1500NK

**B112037036A**

8031453033552

1

# YUMA2800NK

BTL CATEGORIA SCONTO 24

Proiettore solare con pannello separato / Solar floodlight with separate panel

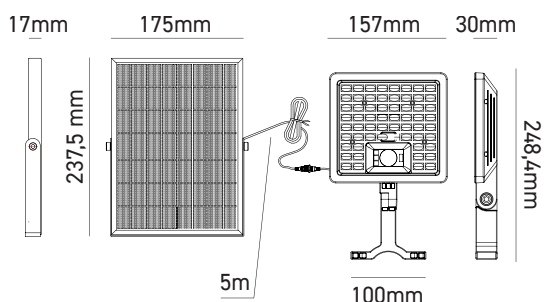

Il proiettore solare perfetto per illuminare spazi esterni senza bisogno di corrente elettrica. Con pannello separato, sensore crepuscolare e telecomando, garantisce praticità e versatilità per ogni impiego

- \_ Proiettore con sensore crepuscolare e rilevatore di presenza PIR
- \_ Facile installazione: non richiede collegamenti alla rete elettrica
- \_ Batteria alta qualità Li-ION 18650, 7.4V, 3600mAh, 26.64Wh
- \_ Il proiettore può essere separato dal pannello ed utilizzato in modalità standalone
- \_ Pannello solare 7,5Wp
- \_ Tempo di ricarica: 5 ore
- \_ Fascio asimmetrico 120° x 60° ampia area di illuminazione
- \_ Materiale ABS + PC anti UV , autoestinguento
- \_ Cavo di connessione di 5m con connettore IP67
- \_ 2 modalità di funzionamento selezionabili e customizzabili tramite il telecomando incluso
- \_ CCT selezionabile

**FUNZIONAMENTO**

Il proiettore ha due modalità di funzionamento, personalizzabili con il telecomando.

**MODALITÀ SENSORE:** il proiettore si accende automaticamente di notte, al 100% dell'emissione quando viene rilevato un movimento nell'intervallo <8-10m, quindi passa al 5% di emissione luminosa 20 secondi dopo aver rilevato l'ultimo movimento.

**MODALITÀ LUCE COSTANTE:** il proiettore si accende automaticamente di notte e rimane acceso per il tempo e l'emissione luminosa selezionati (3h-5h-8h-12h / 20%-40%-60%)

**OPERATION**

The projector features two operating modes, customizable via the remote control.

**SENSOR MODE:** The projector automatically turns on at night, emitting 100% brightness when motion is detected within a range of <8-10m, then switches to 5% brightness 20 seconds after the last motion is detected.

**CONSTANT LIGHT MODE:** The projector automatically turns on at night and remains on for the selected duration and brightness level (3h-5h-8h-12h / 20%-40%-60%)

The perfect solar projector for lighting outdoor spaces without the need for electricity. With a separate panel, twilight sensor, and remote control, it ensures practicality and versatility for any use

- \_ Floodlight with dusk sensor and PIR presence detector
- \_ Easy installation: mains connection not needed
- \_ High quality Li-ION 18650 battery, 7.4V, 3600mAh, 26.64Wh
- \_ Floodlight can be separated from the solar panel for standalone use
- \_ 7,5Wp solar panel
- \_ Charging time: 5 hours
- \_ Wide illumination area, 120° x 60° asymmetric beam angle
- \_ Self-extinguishing ABS + PC anti UV material
- \_ IP67 connector, 5m cable
- \_ 2 selectable and customizable operating modes via the included remote controller
- \_ Selectable CCT



W	K	LUMEN APPARECCHIO lm		VARIANTE	CODICE	EAN	
20	<input type="checkbox"/> 3000 <input type="checkbox"/> 4000 <input type="checkbox"/> 6500	2800	60X120°	-	YUMA2800NK	8031453032692	1/16

Batteria Li-ION 18650 4 celle 7.4V 3600mAh per YUMA2800NK

B114074036A

8031453033590

1

# YUMA4800NK

BTL CATEGORIA SCONTO 24

Proiettore solare con pannello separato / Solar floodlight with separate panel



Il proiettore solare perfetto per illuminare spazi esterni senza bisogno di corrente elettrica. Con pannello separato, sensore crepuscolare e telecomando, garantisce praticità e versatilità per ogni impiego

- \_ Proiettore con sensore crepuscolare e rilevatore di presenza PIR
- \_ Facile installazione: non richiede collegamenti alla rete elettrica
- \_ Batteria alta qualità LiFePO4 32700, 6.4V, 6000mAh, 38.4Wh
- \_ Il proiettore può essere separato dal pannello ed utilizzato in modalità standalone
- \_ Pannello solare 12Wp
- \_ Tempo di ricarica: 6 ore
- \_ Fascio asimmetrico 120° x 60° ampia area di illuminazione
- \_ Materiale ABS + PC anti UV, autoestinguento
- \_ Cavo di connessione di 5m con connettore IP67
- \_ 2 modalità di funzionamento selezionabili e customizzabili tramite il telecomando incluso
- \_ CCT selezionabile

The perfect solar projector for lighting outdoor spaces without the need for electricity. With a separate panel, twilight sensor, and remote control, it ensures practicality and versatility for any use

- \_ Floodlight with dusk sensor and PIR presence detector
- \_ Easy installation: mains connection not needed
- \_ High quality LiFePO4 32700 battery, 6.4V, 6000mAh, 38.4Wh
- \_ Floodlight can be separated from the solar panel for standalone use
- \_ 12Wp solar panel
- \_ Charging time: 6 hours
- \_ Wide illumination area, 120° x 60° asymmetric beam angle
- \_ Self-extinguishing ABS + PC anti UV material
- \_ IP67 connector, 5m cable
- \_ 2 selectable and customizable operating modes via the included remote controller
- \_ Selectable CCT



W	K	LUMEN APPARECCHIO lm		VARIANTE	CODICE	EAN	
30	<input type="checkbox"/> 3000 <input type="checkbox"/> 4000 <input type="checkbox"/> 6500	4800	60X120°	-	YUMA4800NK	8031453032708	1/6

Batteria LiFePO4 32700 2 celle 6,4V 6000mAh per KALAP4800NK e YUMA4800NK

**B222064060A**

8031453033620

1

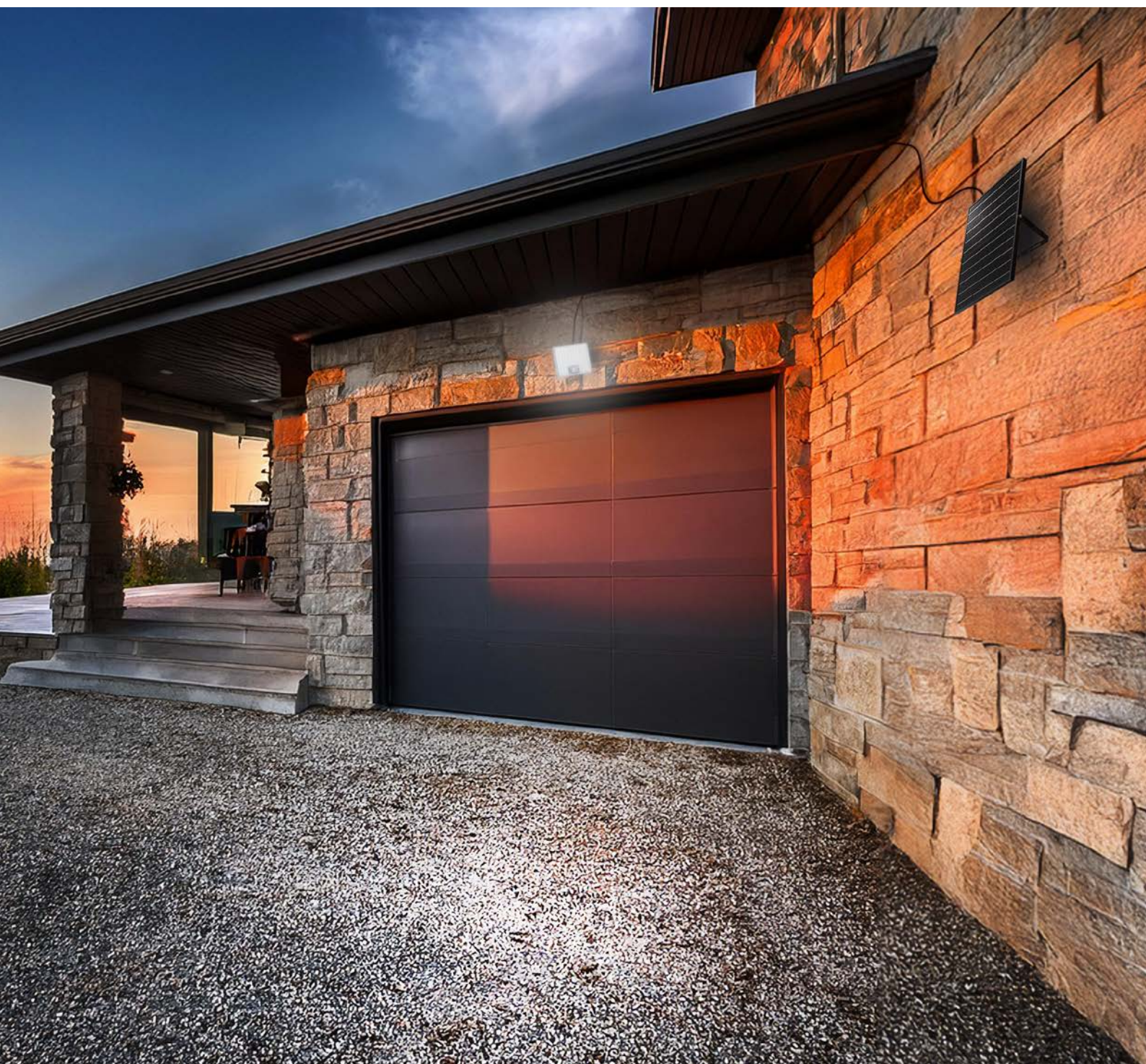

**FUNZIONAMENTO**

Il proiettore ha due modalità di funzionamento, personalizzabili con il telecomando.

**MODALITÀ SENSORE:** il proiettore si accende automaticamente di notte, al 100% dell'emissione quando viene rilevato un movimento nell'intervallo <8-10m, quindi passa al 5% di emissione luminosa 20 secondi dopo aver rilevato l'ultimo movimento.

**MODALITÀ LUCE COSTANTE:** il proiettore si accende automaticamente di notte e rimane acceso per il tempo e l'emissione luminosa selezionati (3h-5h-8h-12h / 20%-40%-60%)

**OPERATION**

The projector features two operating modes, customizable via the remote control.

**SENSOR MODE:** The projector automatically turns on at night, emitting 100% brightness when motion is detected within a range of <8-10m, then switches to 5% brightness 20 seconds after the last motion is detected.

**CONSTANT LIGHT MODE:** The projector automatically turns on at night and remains on for the selected duration and brightness level (3h-5h-8h-12h / 20%-40%-60%)

# YUMA11NK

BTL CATEGORIA SCONTO 24

Proiettore solare stradale / Street solar floodlight

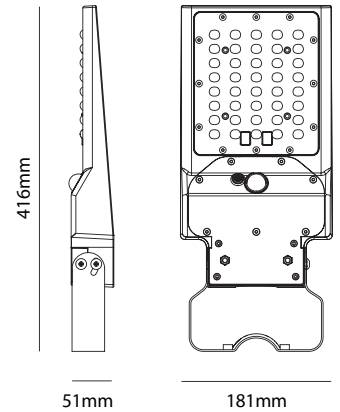

- \_ Proiettore con sensore crepuscolare e rilevatore di presenza PIR
- \_ Facile Installazione: non richiede collegamento alla rete elettrica.
- \_ Batteria alta qualità LiFePO4 32700, 3.2V, 6000mAh, 19.2Wh
- \_ Pannello solare 7,4Wp
- \_ Tempo di ricarica: 4 ore
- \_ Staffa di fissaggio inclusa
- \_ Materiale ABS + PC anti UV , autoestinguento
- \_ CCT selezionabile
- \_ Telecomando incluso

- \_ Floodlight with dusk sensor and PIR presence detector
- \_ Easy to install: does not require connection to mains energy.
- \_ High quality LiFePO4 32700 battery, 3.2V, 6000mAh, 19.2Wh
- \_ 7,4Wp solar panel
- \_ Charging time: 4 hours
- \_ Fixing bracket included
- \_ Material ABS + PC anti UV, self-extinguishing
- \_ Selectable CCT
- \_ Remote controller included



W	K	LUMEN APPARECCHIO lm		VARIANTE	CODICE	EAN	
10	<input checked="" type="checkbox"/> 3000 <input type="checkbox"/> 4000 <input type="checkbox"/> 6500	1500	70x140°	-	YUMA11NK	8031453031916	1/6
Batteria LiFePO4 32700 1 cella 3.2V 6000mAh per YUMA11NK					B221032060A	8031453033613	1



#### **FUNZIONAMENTO**

Premere il pulsante ROSSO sull'apparecchio, si accenderà automaticamente in Modalità 1. Premere nuovamente il pulsante per spostarsi in Modalità 2. Premere una terza volta per spegnere il proiettore ed entrare in Modalità OFF. Il telecomando si può utilizzare fintanto che il proiettore non verrà impostato in Modalità OFF utilizzando il tasto presente sullo stesso. Se l'apparecchio viene settato in Modalità OFF dal telecomando, non ne verrà precluso il funzionamento. La lampada ha funzione memoria se usata tramite telecomando, non ha funzione memoria se utilizzata tramite il pulsante.

SELEZIONE CCT: per selezionare il colore desiderato, una volta acceso il proiettore:

- tenere premuto il tasto sull'apparecchio per 3 secondi (ordine colori: 6500K, 4000K, 3000K)
- utilizzare gli appositi tasti sul telecomando (Warm: 3000K, Neutral: 4000K, Cool: 6500K)

MODALITÀ 1: alla prima pressione del pulsante il proiettore lampeggia una volta per segnalare l'entrata in funzione in Modalità 1. Il proiettore si accende al 100% dell'emissione luminosa quando viene rilevato movimento nel raggio d'azione del sensore (120°-8/10m) per poi passare al 4% dell'emissione luminosa 20 secondi dopo l'ultimo movimento rilevato. Il funzionamento avverrà fino all'alba o all'esaurimento della batteria.

MODALITÀ 2: alla seconda pressione del pulsante il proiettore lampeggia due volte per segnalare l'entrata in funzione in Modalità 2. Il proiettore si accende al 50% dell'emissione luminosa per 6 ore. Passate le 6 ore l'apparecchio passerà automaticamente in Modalità 1 e la manterrà fino all'alba o ad esaurimento della batteria. È possibile personalizzare i parametri di emissione luminosa e durata di funzionamento in questa modalità tramite gli appositi tasti del telecomando.

#### **OPERATION**

*Press the RED button on the appliance, it will turn on automatically in Mode 1. Press the button again to move to Mode 2. Press a third time to turn off the projector and enter OFF Mode. The remote control can be used as long as the projector will not be set to OFF mode by using the button on the projector. If the appliance is set to OFF mode by the remote control, it will not be prevented from operating. The lamp has memory function if used by remote control, it has no memory function if used by the button.*

*CCT SELECTION: to select the color you want, once the projector is turned on:*

- press and hold the button on the appliance for 3 seconds (colors order: 6500K, 4000K, 3000K)*
- use the appropriate buttons on the remote control (Warm: 3000K, Neutral: 4000K, Cool: 6500K)*

*MODE 1: when the button is pressed for the first time, the projector flashes once to signal that it has entered Mode 1. The projector turns on at 100% of the light output when motion is detected within the range of the sensor (120°-8/10m) and then turns on at 4% of the light output 20 seconds after the last motion detected. Operation will occur until the battery is fully discharged or until dawn.*

*MODE 2: on the second press of the button, the projector flashes twice to signal that it has entered Mode 2 operation. The projector turns on at 50% of the light output for 6 hours. After 6 hours, the appliance will automatically switch to Mode 1 and maintain it until dawn or when the battery runs out. It is possible to customize the light emission parameters and operating duration in this mode using the appropriate buttons on the remote control.*

Proiettore solare stradale / Street solar floodlight

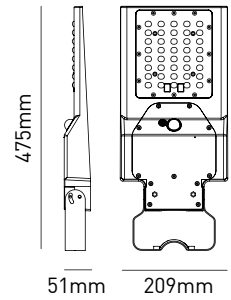

VARIAZIONE FASCIO LUMINOSO  
LIGHT BEAM VARIATION

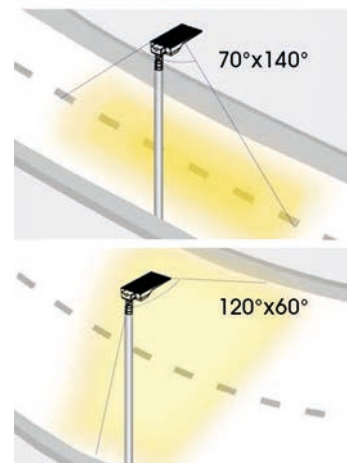

- \_ Proiettore con sensore crepuscolare e rilevatore di presenza PIR
- \_ Dotato di ottica doppia con fascio selezionabile tra 70x140° e 120x60° mediante telecomando
- \_ Facile installazione: non richiede collegamento alla rete elettrica
- \_ Batteria alta qualità LiFePO4 32700, 6.4V, 6000mAh, 38.4Wh
- \_ Pannello solare 10Wp
- \_ Tempo di ricarica: 6 ore
- \_ Materiale ABS + PC anti UV, autoestinguente
- \_ CCT selezionabile
- \_ Telecomando incluso

- \_ Projector with twilight sensor and PIR presence detector
- \_ Equipped with double optics with selectable beam between 70x140° and 120x60° via remote control
- \_ Easy installation: no electrical grid connection required
- \_ High-quality LiFePO4 32700 battery, 6.4V, 6000mAh, 38.4Wh
- \_ 10Wp solar panel
- \_ Charging time: 6 hours
- \_ ABS + UV-resistant, self-extinguishing PC material
- \_ Selectable CCT
- \_ Remote control included



W	K	LUMEN APPARECCHIO lm		VARIANTE	CODICE	EAN	
20	<input checked="" type="checkbox"/> 3000 <input type="checkbox"/> 4000 <input type="checkbox"/> 6500	3000	70x140° 120x60°	-	YUMA20NK	8031453035068	1/6
Batteria LiFePO4 32700 2 celle 6,4V 6000mAh per YUMA15NK e YUMA20NK					B222064060B	8031453033637	1



**FUNZIONAMENTO**

Premere il pulsante ROSSO sull'apparecchio, si accenderà automaticamente in Modalità 1. Premere nuovamente il pulsante per spostarsi in Modalità 2. Premere una terza volta per spegnere il proiettore ed entrare in Modalità OFF. Il telecomando si può utilizzare fintanto che il proiettore non verrà impostato in Modalità OFF utilizzando il tasto presente sullo stesso. Se l'apparecchio viene settato in Modalità OFF dal telecomando, non ne verrà precluso il funzionamento. La lampada ha funzione memoria se usata tramite telecomando, non ha funzione memoria se utilizzata tramite il pulsante.

SELEZIONE CCT: per selezionare il colore desiderato, una volta acceso il proiettore:  
 - tenere premuto il tasto sull'apparecchio per 3 secondi (ordine colori: 6500K, 4000K, 3000K)  
 - utilizzare gli appositi tasti sul telecomando (Warm: 3000K, Neutral: 4000K, Cool: 6500K)

MODALITÀ 1: alla prima pressione del pulsante il proiettore lampeggia una volta per segnalare l'entrata in funzione in Modalità 1. Il proiettore si accende al 100% dell'emissione luminosa quando viene rilevato movimento nel raggio d'azione del sensore (120°-8/10m) per poi passare al 4% dell'emissione luminosa 20 secondi dopo l'ultimo movimento rilevato. Il funzionamento avverrà fino all'alba o all'esaurimento della batteria.

MODALITÀ 2: alla seconda pressione del pulsante il proiettore lampeggia due volte per segnalare l'entrata in funzione in Modalità 2. Il proiettore si accende al 60% dell'emissione luminosa per 3 ore. Passate le 3 ore l'apparecchio passerà automaticamente in Modalità 1 e la manterrà fino all'alba o ad esaurimento della batteria. È possibile personalizzare i parametri di emissione luminosa e durata di funzionamento in questa modalità tramite gli appositi tasti del telecomando.

**OPERATION**

*Press the RED button on the appliance, it will turn on automatically in Mode 1. Press the button again to move to Mode 2. Press a third time to turn off the projector and enter OFF Mode. The remote control can be used as long as the projector will not be set to OFF mode by using the button on the projector. If the appliance is set to OFF mode by the remote control, it will not be prevented from operating. The lamp has memory function if used by remote control, it has no memory function if used by the button.*

*CCT SELECTION: to select the color you want, once the projector is turned on:  
 - press and hold the button on the appliance for 3 seconds (colors order: 6500K, 4000K, 3000K)  
 - use the appropriate buttons on the remote control (Warm: 3000K, Neutral: 4000K, Cool: 6500K)*

*MODE 1: when the button is pressed for the first time, the projector flashes once to signal that it has entered Mode 1. The projector turns on at 100% of the light output when motion is detected within the range of the sensor (120°-8/10m) and then turns on at 4% of the light output 20 seconds after the last motion detected. Operation will occur until the battery is fully discharged or until dawn.*

*MODE 2: on the second press of the button, the projector flashes twice to signal that it has entered Mode 2 operation. The projector turns on at 60% of the light output for 3 hours. After 3 hours, the appliance will automatically switch to Mode 1 and maintain it until dawn or when the battery runs out. It is possible to customize the light emission parameters and operating duration in this mode using the appropriate buttons on the remote control.*

# YUMA40NK AGGIORNATO

BTL CATEGORIA SCONTO 24

Proiettore solare stradale / Street solar floodlight

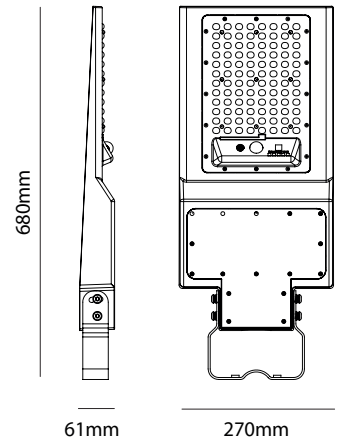

VARIAZIONE FASCIO LUMINOSO  
LIGHT BEAM VARIATION

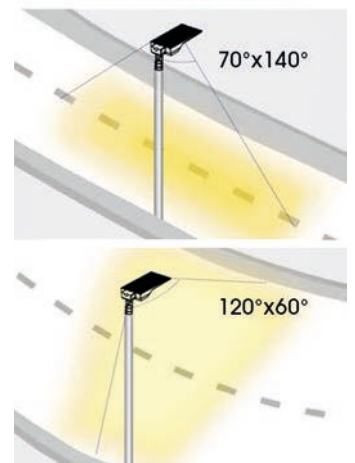

- \_ Proiettore con sensore crepuscolare e rilevatore di presenza PIR
- \_ Dotato di ottica doppia con fascio selezionabile tra 70x140° e 120x60° mediante telecomando
- \_ Facile installazione: non richiede collegamento alla rete elettrica
- \_ Batteria alta qualità LiFePO4 32700, 9.6V, 12000mAh, 115.2Wh
- \_ Pannello solare 21Wp
- \_ Tempo di ricarica: 8 ore
- \_ Materiale ABS + PC anti UV, autoestinguente
- \_ CCT selezionabile
- \_ Telecomando incluso

- \_ Floodlight with twilight sensor and PIR presence detector
- \_ Equipped with double optics with selectable beam between 70x140° and 120x60° via remote control
- \_ Easy installation: no electrical grid connection required
- \_ High-quality LiFePO4 32700 battery, 9.6V, 12000mAh, 115.2Wh
- \_ 21Wp solar panel
- \_ Charging time: 8 hours
- \_ ABS + UV-resistant, self-extinguishing PC material
- \_ Selectable CCT
- \_ Remote control included



W	K	LUMEN APPARECCHIO lm		VARIANTE	CODICE	EAN	
40	<input checked="" type="checkbox"/> 3000 <input type="checkbox"/> 4000 <input type="checkbox"/> 6500	6600	70x140° 120x60°	-	<b>YUMA40NK</b>	8031453031930	1/3
Batteria LiFePO4 32700 6 celle 9.6V 12000mAh per YUMA40NK e YUMA63HY					<b>B226096012A</b>	8031453033651	1



#### **FUNZIONAMENTO**

Premere il pulsante ROSSO sull'apparecchio, si accenderà automaticamente in Modalità 1. Premere nuovamente il pulsante per spostarsi in Modalità 2. Premere una terza volta per spegnere il proiettore ed entrare in Modalità OFF. Il telecomando si può utilizzare fingendo che il proiettore non verrà impostato in Modalità OFF utilizzando il tasto presente sullo stesso. Se l'apparecchio viene settato in Modalità OFF dal telecomando, non ne verrà precluso il funzionamento. La lampada ha funzione memoria se usata tramite telecomando, non ha funzione memoria se utilizzata tramite il pulsante.

SELEZIONE CCT: per selezionare il colore desiderato, una volta acceso il proiettore:

- tenere premuto il tasto sull'apparecchio per 3 secondi (ordine colori: 6500K, 4000K, 3000K)
- utilizzare gli appositi tasti sul telecomando (Warm: 3000K, Neutral: 4000K, Cool: 6500K)

MODALITÀ 1: alla prima pressione del pulsante il proiettore lampeggia una volta per segnalare l'entrata in funzione in Modalità 1. Il proiettore si accende al 100% dell'emissione luminosa quando viene rilevato movimento nel raggio d'azione del sensore (120°-8/10m) per poi passare al 4% dell'emissione luminosa 20 secondi dopo l'ultimo movimento rilevato. Il funzionamento avverrà fino all'alba o all'esaurimento della batteria.

MODALITÀ 2: alla seconda pressione del pulsante il proiettore lampeggia due volte per segnalare l'entrata in funzione in Modalità 2. Il proiettore si accende al 60% dell'emissione luminosa per 3 ore che manterrà fino all'alba o ad esaurimento della batteria. È possibile personalizzare i parametri di emissione luminosa e durata di funzionamento in questa modalità tramite gli appositi tasti del telecomando.

#### **OPERATION**

Press the RED button on the appliance, it will turn on automatically in Mode 1. Press the button again to move to Mode 2. Press a third time to turn off the projector and enter OFF Mode. The remote control can be used as long as the projector will not be set to OFF mode by using the button on the projector. If the appliance is set to OFF mode by the remote control, it will not be prevented from operating. The lamp has memory function if used by remote control, it has no memory function if used by the button.

CCT SELECTION: to select the color you want, once the projector is turned on:

- press and hold the button on the appliance for 3 seconds (colors order: 6500K, 4000K, 3000K)
- use the appropriate buttons on the remote control (Warm: 3000K, Neutral: 4000K, Cool: 6500K)

MODE 1: when the button is pressed for the first time, the projector flashes once to signal that it has entered Mode 1. The projector turns on at 100% of the light output when motion is detected within the range of the sensor (120°-8/10m) and then turns on at 4% of the light output 20 seconds after the last motion detected. Operation will occur until the battery is fully discharged or until dawn.

MODE 2: on the second press of the button, the projector flashes twice to signal that it has entered Mode 2 operation. The projector turns on at 60% of the light output for 3 hours that will maintain until dawn or when the battery runs out. It is possible to customize the light emission parameters and operating duration in this mode using the appropriate buttons on the remote control.



**SHOT**  
BOT LIGHTING

**RESIDENZIALE / LAMPADE SOLARI**  
RESIDENTIAL / SOLAR LAMPS

# INCLINE2N

BTL CATEGORIA SCONTO 24

Proiettore solare / Solar floodlight

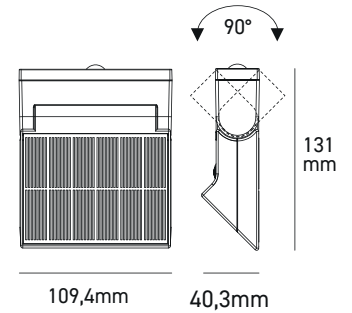
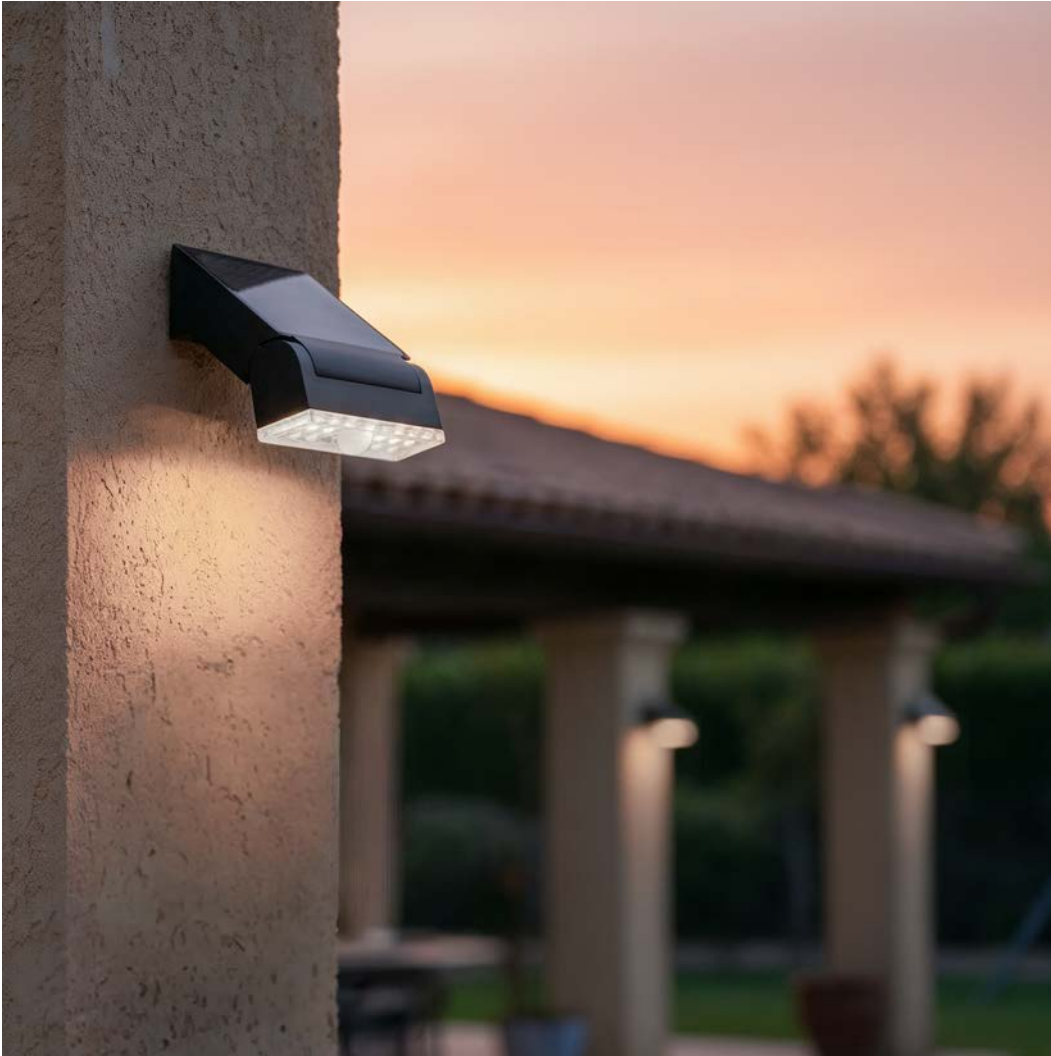

Per il funzionamento  
vedi pagina

For the product's operation  
see page

463





Questa applique solare con luce orientabile unisce praticità e sostenibilità, illuminando i tuoi spazi esterni solo quando serve grazie al sensore di movimento integrato. In aggiunta è possibile attivare la luce di cortesia durante le ore notturne.

- \_ Wall light con sensore crepuscolare e rilevatore di presenza PIR
- \_ Facile installazione: non richiede collegamenti alla rete elettrica
- \_ Batteria Li-ION 18650, 3.7V, 1200mAh, 4.44Wh
- \_ Pannello solare 1Wp
- \_ Tempo di ricarica 5 ore
- \_ Testa orientabile di 90°
- \_ Materiale ABS + PC anti UV , autoestinguente
- \_ 2 modalità di funzionamento
- \_ Luce di cortesia 3000K

*This solar wall light with adjustable illumination combines practicality and sustainability, lighting up your outdoor spaces only when needed thanks to the integrated motion sensor. Additionally, it is possible to activate courtesy lighting during nighttime hours.*

- \_ Wall light with dusk sensor and PIR motion detector
- \_ Easy installation: mains connection not needed
- \_ High quality Li-ION 18650 battery, 3.7V, 1200mAh, 4.44Wh
- \_ 1Wp solar panel
- \_ 5 hours charging time
- \_ 90° adjustable head
- \_ Self-extinguishing ABS + PC anti UV material
- \_ 2 operating modes
- \_ 3000K courtesy light



W	K	LUMEN APPARECCHIO lm		VARIANTE	CODICE	EAN	
2	<input type="checkbox"/> 4000	300	60x120°	-	INCLINE2N	8031453033040	1/24
Batteria Li-ION 18650 1 cella 3.7V 1200mAh per INCLINE2N					B111037012B	8031453033477	1

# INCLINE4N

BTL CATEGORIA SCONTO 24

Proiettore solare / Solar floodlight

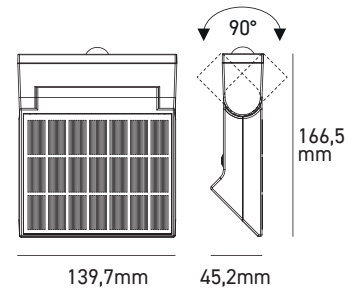

Per il funzionamento  
vedi pagina

For the product's operation  
see page

463





Questa applique solare con luce orientabile unisce praticità e sostenibilità, illuminando i tuoi spazi esterni solo quando serve grazie al sensore di movimento integrato. In aggiunta è possibile attivare la luce di cortesia durante le ore notturne.

- \_ Wall light con sensore crepuscolare e rilevatore di presenza PIR
- \_ Facile installazione: non richiede collegamenti alla rete elettrica
- \_ Batteria Li-ION 18650, 3.7V, 2000mAh, 7.4Wh
- \_ Pannello solare 2,2Wp
- \_ Tempo di ricarica 5 ore
- \_ Testa orientabile di 90°
- \_ Materiale ABS + PC anti UV, autoestinguente
- \_ 2 modalità di funzionamento
- \_ Luce di cortesia 3000K

This solar wall light with adjustable illumination combines practicality and sustainability, lighting up your outdoor spaces only when needed thanks to the integrated motion sensor. Additionally, it is possible to activate courtesy lighting during nighttime hours.

- \_ Wall light with dusk sensor and PIR motion detector
- \_ Easy installation: mains connection not needed
- \_ High quality Li-ION 18650 battery, 3.7V, 2000mAh, 7.4Wh
- \_ 2,2Wp solar panel
- \_ 5 hours charging time
- \_ 90° adjustable head
- \_ Self-extinguishing ABS + PC anti UV material
- \_ 2 operating modes
- \_ 3000K courtesy light



W	K	LUMEN APPARECCHIO lm		VARIANTE	CODICE	EAN	
4	<input type="checkbox"/> 4000	600	60x120°	-	INCLINE4N	8031453033057	1/24
Batteria Li-ION 18650 1 cella 3.7V 2000mAh per INCLINE4N					B111037020B	8031453033491	1

# INCLINE8N

BTL CATEGORIA SCONTO 24

Proiettore solare / Solar floodlight

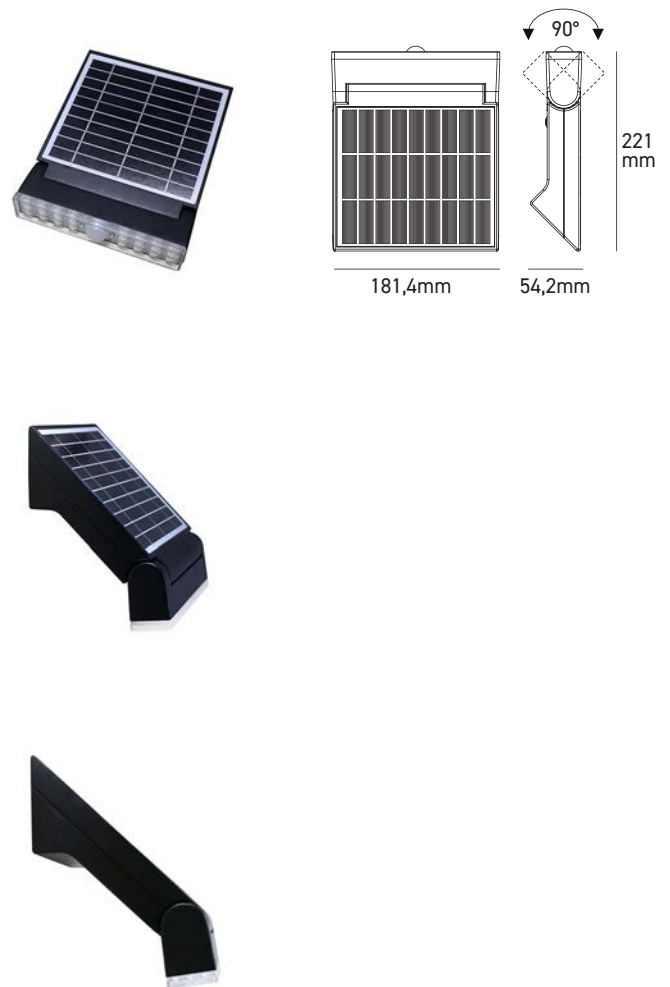

Questa applique solare con luce orientabile unisce praticità e sostenibilità, illuminando i tuoi spazi esterni solo quando serve grazie al sensore di movimento integrato. In aggiunta è possibile attivare la luce di cortesia durante le ore notturne.

- \_ Wall light con sensore crepuscolare e rilevatore di presenza PIR
- \_ Facile installazione: non richiede collegamenti alla rete elettrica
- \_ Batteria Li-ION 18650, 3.7V, 4000mAh, 14.8Wh
- \_ Pannello solare 4,2Wp
- \_ Tempo di ricarica 5 ore
- \_ Testa orientabile di 90°
- \_ Materiale ABS + PC anti UV , autoestinguente
- \_ 2 modalità di funzionamento
- \_ Luce di cortesia 3000K

*This solar wall light with adjustable illumination combines practicality and sustainability, lighting up your outdoor spaces only when needed thanks to the integrated motion sensor. Additionally, it is possible to activate courtesy lighting during nighttime hours.*

- \_ Wall light with dusk sensor and PIR motion detector
- \_ Easy installation: mains connection not needed
- \_ High quality Li-ION 18650 battery, 3.7V, 4000mAh, 14.8Wh
- \_ 4,2Wp solar panel
- \_ 5 hours charging time
- \_ 90° adjustable head
- \_ Self-extinguishing ABS + PC anti UV material
- \_ 2 operating modes
- \_ 3000K courtesy light



W	K	LUMEN APPARECCHIO lm		VARIANTE	CODICE	EAN	
8	<input type="checkbox"/> 4000	1200	60x120°	-	<b>INCLINE8N</b>	8031453033064	1/12
Batteria LHON 18650 2 celle 3,7V 4000mAh per INCLINE8N					<b>B112037040A</b>	8031453033569	1

INCLINE8N



### FUNZIONAMENTO APPLIQUE SOLARI INCLINE2/4/8

L'apparecchio ha due modalità di funzionamento, selezionabili tramite il pulsante sul retro. La luce di cortesia posta sul retro dell'apparecchio emette una luce di colore 3000K, la luce principale posta sulla porzione frontale emette una luce di colore 4000K.

**MODALITÀ 1:** la luce principale e la luce di cortesia si accendono al 100% di emissione luminosa quando viene rilevato un movimento e rimangono accese per 20 secondi dopo l'ultimo movimento rilevato. Passati i 20 secondi dall'ultimo rilevamento, rimane accesa al 100% di emissione luminosa solo la luce di cortesia.

**MODALITÀ 2:** la luce principale si accende al 100% di emissione luminosa quando viene rilevato un movimento e rimane accesa per 20 secondi dopo l'ultimo movimento rilevato. Passati i 20 secondi dall'ultimo rilevamento, l'apparecchio si spegne. In questa modalità la luce di cortesia rimane sempre spenta.

### INCLINE2/4/8 SOLAR LAMP OPERATIONS

The device has two operating modes, selectable via the button on the back. The courtesy light located on the back of the device emits a 3000K light, while the main light on the front emits a 4000K light.

**MODE 1:** The main light and the courtesy light turn on at 100% brightness when motion is detected and remain on for 20 seconds after the last detected motion. After 20 seconds from the last motion detection, only the courtesy light remains on at 100% brightness.

**MODE 2:** The main light turns on at 100% brightness when motion is detected and remains on for 20 seconds after the last detected motion. After 20 seconds from the last motion detection, the device turns off. In this mode, the courtesy light always remains off.

# YUMA2N

BTL CATEGORIA SCONTO 24

Proiettore solare / Solar floodlight



**FUNZIONAMENTO**

Quando la batteria è carica (>30%), la lampada si accende alla massima luminosità (240lm) quando il sensore rileva ad un distanza ≤6 m un movimento. Dopo 10 secondi senza rilevamento, automaticamente si posiziona al 20% con luce frontale e posteriore.

Quando la batteria è al di sotto del 30% di carica, la lampada si accende alla massima luminosità (240lm) quando il sensore rileva ad un distanza ≤6 m un movimento. Dopo 10 secondi senza rilevamento, automaticamente la lampada si spegne.

**OPERATION**

When the battery is charged (>30%), the light switches on at maximum brightness (240 lm) when the sensor detects a movement at a distance of ≤6 m. After 10 seconds with no movement detected, the front and rear brightness automatically reduces to 20%

When the battery has less than 30% charge, the light switches on at maximum brightness (240 lm) when the sensor detects a movement at a distance of ≤6 m. After 10 seconds with no movement detected, the light automatically switches off.

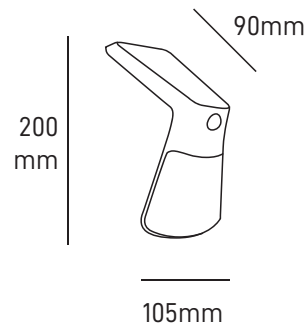

- \_ Wall Light con sensore crepuscolare e rilevatore di presenza PIR
- \_ Facile Installazione: non richiede collegamenti alla rete elettrica.
- \_ Luce di cortesia indiretta sempre accesa di notte
- \_ Batteria Li-ION 18650, 3.7V, 1200mAh, 8.4Wh
- \_ Pannello solare 0,7W
- \_ Tempo di ricarica: 6 ore
- \_ Materiale ABS + PC anti UV , autoestinguento

- \_ Wall light with PIR motion and dusk sensor
- \_ Easy Installation: does not require connections to the electrical network.
- \_ Indirect courtesy light always on at night
- \_ Li-ION 18650 battery 3.7V, 1200mAh, 8.4Wh
- \_ 0,7Wp solar panel
- \_ Charging time: 6 hours
- \_ Material ABS + PC anti UV, self-extinguishing

IP 65
IK 08
II
35.000h  
2 ANNI GARANZIA
-15°+45°
PIR
☀️
🏠

W	K	LUMEN APPARECCHIO lm	◀▶	VARIANTE	CODICE	EAN	📦
2	4000	240	90°	-	YUMA2N	8031453020699	1/24

# YUMA8NP

BTL CATEGORIA SCONTO 24

Proiettore e picchetto solare / Solar and stake light



**FUNZIONAMENTO**

Il paletto ha quattro modalità di funzionamento, selezionabili con il telecomando.

MODALITÀ 1: quando viene rilevato movimento la luce si accende al 100% per 30 secondi.

MODALITÀ 2: quando non viene rilevato movimento la luce rimane accesa al 10%, al rilevamento la luce passa al 100% per 30 secondi.

MODALITÀ 3: la luce rimane accesa al 10%, il sensore di movimento rimane inattivo.

MODALITÀ SOS: quando viene rilevato movimento, la luce emette il segnale di SOS.

**OPERATION**

The floodlight has four working modes, selectable with the remote control.

MODE 1: when the person enters the detection area, the light will be 100% for 30sec.

MODE 2: no one enters the detection area, keep the light to 10%. When movement is detected, the light will be 100% for 30sec.

MODE 3: light stays 10%, the movement sensor will be deactivated.

MODE SOS: When the person enters the detection area, SOS signal flashing from the device.

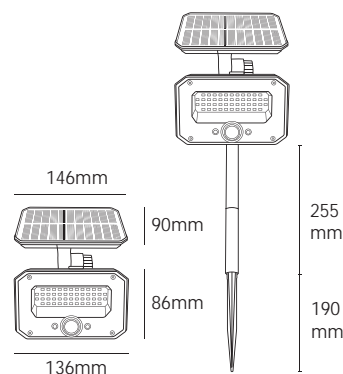

- \_ Proiettore con sensore crepuscolare e rilevatore di presenza PIR
- \_ Facile Installazione: non richiede collegamenti alla rete elettrica.
- \_ 2 batterie Li-ION 18650, 3.7V, 2400mAh, 8,88Wh
- \_ Pannello solare 1,5Wp
- \_ Tempo di ricarica: 8 ore
- \_ Il proiettore può essere utilizzato sia a parete che con picchetto a terra
- \_ Materiale ABS + PC anti UV , autoestinguente
- \_ Telecomando incluso
- \_ 4 modalità di funzionamento selezionabili

- \_ Floodlight with dusk sensor and PIR presence detector
- \_ Easy Installation: does not require connections to the electrical network.
- \_ 2x Li-ION 18650 battery, 3.7V, 2400mAh, 8,88Wh
- \_ 1,5Wp solar panel
- \_ Charging time: 8 hours
- \_ The floodlight can be used both on the wall and with a ground spike
- \_ Material ABS + PC anti UV, self-extinguishing
- \_ Remote control included
- \_ 4 selectable operating modes



W	K	LUMEN APPARECCHIO lm		VARIANTE	CODICE	EAN	
8	4000	850	60x120°	-	YUMA8NP	8031453028701	1/8

Batteria Li-ION 18650 1 cella 3,7V 2400mAh per YUMA8NP (necessari 2 pezzi)

**B11 1037024Z**

8031453033545

1

# MARBELLA10SUN

BTL CATEGORIA SCONTO 24

Applique solare / Solar wall lamp



**MARBELLAPOLEN**  
Accessorio / Accessory

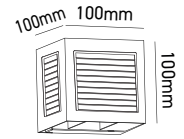

Accessori / Accessories

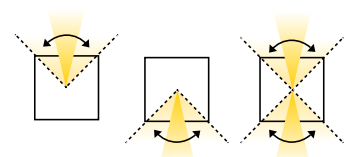
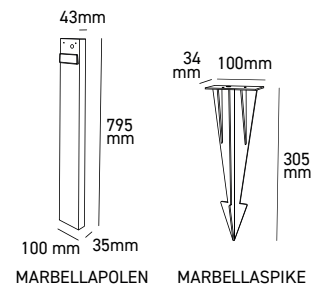



Emissione up & down attivabile singolarmente.  
Fascio regolabile.  
Up & down emission individually selectable. Adjustable beam.

- \_ Applique solare da parete in alluminio per esterni con sensore crepuscolare e rilevatore di presenza
- \_ Fascio up and down regolabile 0° - 90° senza l'uso di attrezzi
- \_ Accensione fasci indipendente
- \_ Facile Installazione: non richiede collegamenti alla rete elettrica
- \_ Batteria Li-ION 18650, 3.7V, 2600mAh, 9.62Wh
- \_ Tempo di ricarica solare: 8 ore, tempo di ricarica con cavo: 4 ore
- \_ Completa di cavo di alimentazione USB-C da 1m (alimentatore non incluso)
- \_ In opzione: picchetto e paletto per installazione su tutti i tipi superficie
- \_ CCT selezionabile

- \_ Aluminum solar wall light for outdoor use with dusk sensor and presence detector
- \_ Adjustable up and down beam from 0° to 90° without tools
- \_ Independent beam ignition
- \_ Easy installation: no electrical wiring required
- \_ Li-ION 18650 battery, 3.7V, 2600mAh, 9.62Wh
- \_ Solar charging time: 8 hours, wired charging time: 4 hours
- \_ Supplied with 1m USB-C power cable (power adapter not included)
- \_ Optional: spike and stake for installation on all types of surfaces
- \_ Selectable CCT



W	K	LUMEN APPARECCHIO lm		VARIANTE	CODICE	EAN	
9	<input type="checkbox"/> 3000 <input type="checkbox"/> 4000 <input type="checkbox"/> 6000	1000	2x90°	-	<b>MARBELLA10SUN</b>	8031453034603	1
Paletto per MARBELLA10SUN Nero 800mm / Post for MARBELLA10SUN Black 800mm					<b>MARBELLAPOLEN</b>	8031453034740	1
Picchetto per paletto per MARBELLAPOLEN / Stake for MARBELLAPOLEN					<b>MARBELLASPIKE</b>	8031453032449	1
Batteria Li-ION 18650 1 cella 3.7V 2600mAh per MARBELLA9SUN e MARBELLA10SUN					<b>B111037026A</b>	8031453033514	1

**FUNZIONAMENTO**

Sul retro dell'apparecchio sono presenti 4 selettori utili a impostare il proiettore solare secondo i parametri preferiti: CCT, soglia di intervento, tempo di accensione e modalità di funzionamento.

CCT: 3000K - 4000K - 6000K

Soglia di intervento: 5-30 lux

Tempo di accensione: 20-120 secondi

Modalità di funzionamento:

- OFF: apparecchio spento
- ON: apparecchio sempre acceso al 25% di emissione luminosa se la luminosità ambientale è al di sotto della soglia di intervento impostata
- AUTO: quando la luminosità ambientale è al di sotto della soglia di intervento impostata, l'apparecchio si accenderà al 100% dell'emissione luminosa quando viene rilevato un movimento nel raggio di rilevamento del sensore. Si spengerà passato il tempo di accensione, impostato in precedenza, dopo l'ultimo movimento rilevato
- DIM: quando la luminosità ambientale è al di sotto della soglia di intervento impostata, l'apparecchio si accenderà al 100% dell'emissione luminosa quando viene rilevato un movimento nel raggio di rilevamento del sensore. Passerà al 5% di emissione luminosa passato il tempo di accensione, impostato in precedenza, dopo l'ultimo movimento rilevato.

**MARBELLAPOLE**  
 ACCESSORIO / ACCESSORY
**OPERATION**

On the back of the fixture, there are 4 selectors to configure the solar spotlight according to preferred settings: CCT, activation threshold, lighting duration, and operating mode.

CCT: 3000K - 4000K - 6000K

Intervention threshold: 5-30 lux

Lighting duration: 20-120 seconds

Operating modes:

- OFF: fixture off
- ON: fixture always on at 25% brightness when ambient light is below the set threshold
- AUTO: when ambient light is below the set threshold, the fixture turns on at 100% brightness upon motion detection within the sensor range and turns off after the set lighting duration following the last detected movement
- DIM: when ambient light is below the set threshold, the fixture turns on at 100% brightness upon motion detection within the sensor range and turns to 5% brightness after the set lighting duration following the last detected movement.

# MARBELLA9SUN

BTL CATEGORIA SCONTO 24

Applique solare / Solar wall lamp

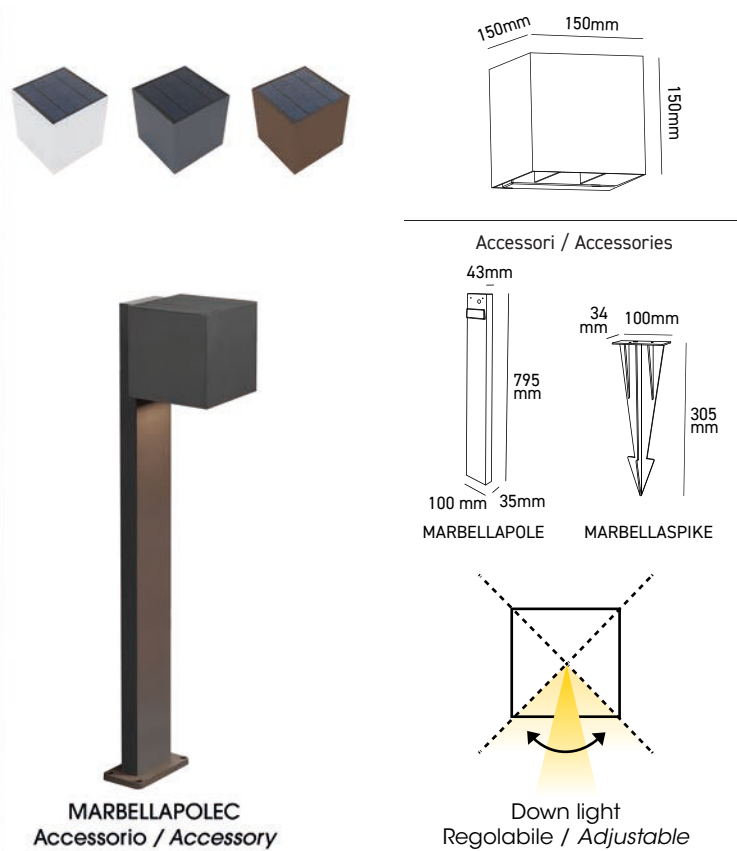

- \_ Applique da parete in alluminio per esterni con sensore crepuscolare e rilevatore di presenza a microonde
- \_ Fascio regolabile 0° - 95° senza l'uso di attrezzi
- \_ Scala graduata per regolazione dell'ampiezza del fascio
- \_ Facile Installazione: non richiede collegamenti alla rete elettrica
- \_ Batteria Li-ION 18650, 3.7V, 2600mAh, 9.62Wh
- \_ Tempo di ricarica: 6 ore
- \_ In opzione: picchetto e paletto per installazione su tutti i tipi superficie

- \_ Outdoor aluminum wall light with dusk sensor and microwave presence detector
- \_ Individually adjustable light beam 0°-95° no tools needed
- \_ Graduated scale to adjust the beam width
- \_ Easy to install: does not require connection to mains energy
- \_ Li-ION 18650 battery, 3.7V, 2600mAh, 9.62Wh
- \_ Charging time: 6 hours
- \_ Optional: spike and stake for installation on all types of surfaces



W	K	LUMEN APPARECCHIO lm		VARIANTE	CODICE	EAN		
9		3000	670	95°	<input type="checkbox"/> BIANCO / WHITE	<b>MARBELLA9SUNB2</b>	8031453032142	1/6
9	<input type="checkbox"/>	4000	670	95°	<input type="checkbox"/> BIANCO / WHITE	<b>MARBELLA9SUNB</b>	8031453030773	1/6
9		3000	620	95°	<input checked="" type="checkbox"/> ANTRACITE / ANTHRACITE	<b>MARBELLA9SUNG2</b>	8031453032166	1/6
9	<input type="checkbox"/>	4000	620	95°	<input checked="" type="checkbox"/> ANTRACITE / ANTHRACITE	<b>MARBELLA9SUNG</b>	8031453030780	1/6
9		3000	610	95°	<input checked="" type="checkbox"/> CORTEN	<b>MARBELLA9SUNC2</b>	8031453032159	1/6
9	<input type="checkbox"/>	4000	610	95°	<input checked="" type="checkbox"/> CORTEN	<b>MARBELLA9SUNC</b>	8031453030797	1/6
Paletto per MARBELLA9SUN Corten 800mm / Pole for MARBELLA9SUN Corten 800mm					<b>MARBELLAPOLEC</b>	8031453032425	1	
Paletto per MARBELLA9SUN Antracite 800mm / Pole for MARBELLA9SUN Anthracite 800mm					<b>MARBELLAPOLEG</b>	8031453032432	1	
Picchetto per paletto per MARBELLAPOLE / Stake for MARBELLAPOLE					<b>MARBELLASPIKE</b>	8031453032449	1	
Batteria Li-ION 18650 1 cella 3,7V 2600mAh per MARBELLA9SUN e MARBELLA10SUN					<b>B111037026A</b>	8031453033514	1	

**FUNZIONAMENTO**

Per passare da una modalità all'altra tenere premuto il pulsante ON/OFF per 3 secondi mentre è acceso l'apparecchio, quest'ultimo lampeggerà per confermare il passaggio alla modalità successiva. Il pannello solare funge anche da sensore crepuscolare e farà attivare l'apparecchio al di sotto dei 15lux.

Modalità 1: Se viene rilevato un movimento, l'apparecchio si accende al 100%. Se non viene rilevato nessun movimento per 30 secondi, l'emissione luminosa passa automaticamente a 25lm (3% di emissione).

Modalità 2: Se viene rilevato un movimento, l'apparecchio si accende al 100%. Se non viene rilevato movimento per 30 secondi, si spegne.

Modalità 3: L'apparecchio rimarrà sempre acceso al 10% di emissione (55 lumen) finché la luminosità ambientale non supererà i 15 lux.

**MARBELLAPOLE**  
 ACCESSORIO / ACCESSORY
**OPERATION**

To switch between modes, press and hold the ON/OFF button for 3 seconds while the fixture is switched on, it will flash to confirm the switch to the next mode. The solar panel also acts as a dusk sensor and will activate the fixture below 15lux.

Mode 1: If motion is detected, the fixture switches on at 100% emission. If no motion is detected for 30 seconds, the light output automatically switches to 25lm (3% of light output).

Mode 2: If motion is detected, the fixture switches on at 100% emission. If no movement is detected for 30 seconds, it will turn off.

Mode 3: The luminaire will always remain on at 10% output (55 lumen) as long as the ambient brightness does not exceed 15 lux.

Testa palo solare da giardino / Solar garden post head

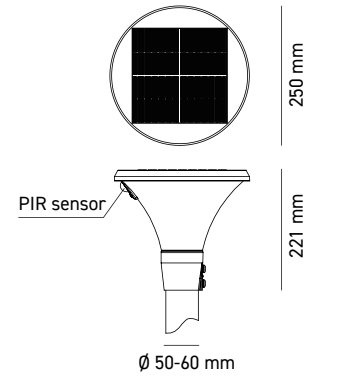

Accessorio / Accessory

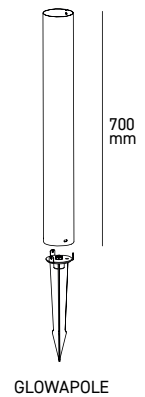

**GLOWAPOLE**  
Accessorio / Accessory

- \_ Testa palo solare con sensore crepuscolare e rilevatore di presenza PIR
- \_ Composto di adattatore per installazione per pali con diametro 50/60mm
- \_ Batteria alta qualità Li-ION 18650, 3.7V, 6000mAh, 22.2Wh
- \_ Pannello solare 6,2Wp
- \_ Tempo di ricarica: 6 ore
- \_ Materiale ABS + PC anti UV , autoestinguente
- \_ 2 modalità di funzionamento selezionabili e customizzabili tramite il telecomando incluso
- \_ In opzione: picchetto in alluminio e paletto in acciaio per installazione su tutti i tipi di superficie
- \_ CCT selezionabile

- \_ Solar post head with dusk sensor and PIR motion detector
- \_ Includes adapter for installation on poles with 50/60mm diameter
- \_ High-quality Li-ION 18650 battery, 3.7V, 6000mAh, 22.2Wh
- \_ 6.2Wp solar panel
- \_ Charging time: 6 hours
- \_ Self-extinguishing ABS + PC anti UV material
- \_ 2 selectable and customizable operating modes via the included remote control
- \_ Optional: aluminum stake and steel post for installation on all types of surfaces
- \_ Selectable CCT



W	K	LUMEN APPARECCHIO lm		VARIANTE	CODICE	EAN	
8	<div style="display: flex; flex-direction: column; gap: 5px;"> <div style="display: flex; align-items: center;"><span style="width: 15px; height: 15px; background-color: #FFD700; border: 1px solid black;"></span> 3000</div> <div style="display: flex; align-items: center;"><span style="width: 15px; height: 15px; background-color: #FFFFFF; border: 1px solid black;"></span> 4000</div> <div style="display: flex; align-items: center;"><span style="width: 15px; height: 15px; background-color: #ADD8E6; border: 1px solid black;"></span> 6500</div> </div>	950	180°	-	<b>GLOWA</b>	8031453034825	1/4
Paletto per GLOWA Nero 700mm con picchetto / Black 700mm stake with spike for GLOWA					<b>GLOWAPOLE</b>	8031453034832	1
Batteria Li-ION 18650 3 celle 3,7V 6000mAh per GLOWA					<b>B113037060A</b>	8031453034863	1



#### **FUNZIONAMENTO**

L'apparecchio ha due modalità di funzionamento, personalizzabili con il telecomando.

**MODALITÀ SENSORE:** l'apparecchio si accenderà automaticamente al tramonto al 10% di emissione luminosa. Quando viene rilevato movimento nel raggio di rilevamento dei sensori l'emissione luminosa passa al 100%, per poi tornare al 10% se per 20 secondi non viene rilevato alcun movimento. L'apparecchio si spegnerà al sorgere del sole o quando la batteria sarà completamente scarica.

**MODALITÀ LUCE COSTANTE:** l'apparecchio si accenderà al tramonto secondo le impostazioni di default: 60% di emissione luminosa costante per 3 ore. Dopo le 3 ore l'apparecchio passerà in MODALITÀ SENSORE. È possibile personalizzare i valori di emissione luminosa e durata del funzionamento in MODALITÀ LUCE COSTANTE tramite il telecomando.

#### **OPERATION**

The projector has two operating modes, customizable with the remote control.

**SENSOR MODE:** The device automatically turns on at sunset at 10% brightness. When motion is detected within the sensor's detection range, the brightness increases to 100%, then returns to 10% if no motion is detected for 20 seconds. The device will turn off at sunrise or when the battery is completely discharged.

**CONSTANT LIGHT MODE:** The device will turn on at sunset according to the default settings: 60% constant brightness for 3 hours. After 3 hours, the device will switch to SENSOR MODE. It is possible to customize the brightness level and operating duration in CONSTANT LIGHT MODE using the remote control.

# YUMA350P

BTL CATEGORIA SCONTO 24

Palo solare da giardino / Garden solar bollard light



- \_ Palletto solare da giardino con sensore crepuscolare
- \_ Corpo in fusione di alluminio e diffusore in policarbonato
- \_ Batteria di alta qualità LiFePO4 3,2V, 6000mAh, 19,2Wh
- \_ Pannello solare 4,5Wp
- \_ Tempo di ricarica: 7 ore
- \_ Curva di emissione luminosa ottimizzata nel periodo di funzionamento
- \_ CCT selezionabile
- \_ Picchetto per installazione su terreno venduto separatamente

- \_ Solar bollard with dusk sensor
- \_ Die-cast aluminum body and polycarbonate diffuser
- \_ LiFePO4 high quality battery 3,2V, 6000mAh, 19,2Wh
- \_ 4,5Wp solar panel
- \_ Charging time: 7 hours
- \_ Optimized light output curve over the working period
- \_ Selectable CCT
- \_ Ground installation spike sold separately



W	K	LUMEN APPARECCHIO lm		VARIANTE	CODICE	EAN	
2,8	<input type="checkbox"/> 3000 <input type="checkbox"/> 4000	350	120	-	<b>YUMA350P</b>	8031453031206	1/4
Picchetto per YUMA350P e YUMA1200P / Ground spike for YUMA350P and YUMA1200P					<b>YUMASPIKE</b>	8031453031305	1
Batteria LiFePO4 18730 3 celle 3,2V 6000mAh per YUMA350P					<b>B222032070A</b>	8031453033668	1

**FUNZIONAMENTO**

Premere il tasto per accendere il proiettore e cambiare il colore della luce da 3000K a 4000K. Nel passaggio da un CCT all'altro l'apparecchio viene spento.

Il proiettore si accenderà al tramonto e rimarrà acceso fino all'esaurimento della batteria, al sorgere del sole o comunque per un massimo di 12 ore.

L'apparecchio è dotato di un controllore che automaticamente gestisce l'emissione luminosa con il progredire della notte e funziona come segue:

- 1° ora / 100% di emissione
- 2° ora / 80% di emissione
- 3°-4° ora / 60% di emissione
- 5°-7° ora / 40% di emissione
- 8°-12° ora / 30% di emissione



**OPERATION**

Press the key to turn on the projector and change the light color from 3000K to 4000K. When switching from one CCT to another, the device is switched off.

The projector will turn on at dusk and will remain on until the battery runs out, the sun rises, or otherwise for up to 12 hours.

The luminaire is equipped with a controller that automatically manages the light output as the night progresses and works as follows:

- 1° hour / 100% brightness
- 2° hour / 80% brightness
- 3°-4° hour / 60% brightness
- 5°-7° hour / 40% brightness
- 8°-12° hour / 30% brightness

# YUMA1200P

BTL CATEGORIA SCONTO 24

Palo solare da giardino / Garden solar bollard light

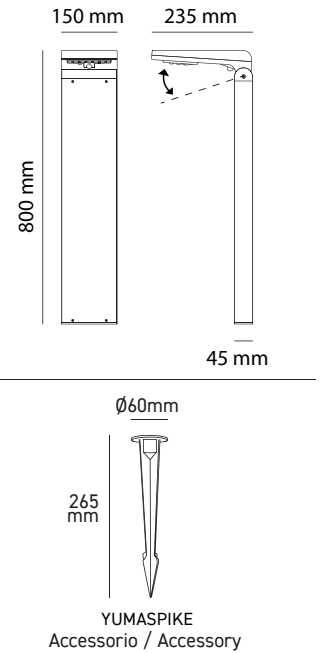

- \_ Paletto solare da giardino con sensore crepuscolare e rilevatore di presenza PIR
- \_ Corpo in fusione di alluminio e diffusore in policarbonato
- \_ Batteria di alta qualità LiFePO4 3,2V, 8000mAh, 25,6Wh
- \_ Pannello solare 5Wp
- \_ Tempo di ricarica: 8 ore
- \_ 2 modalità di funzionamento
- \_ Pannello orientabile di 15°
- \_ Picchetto per installazione su terreno venduto separatamente

- \_ Solar bollard with dusk sensor and PIR presence detector
- \_ Die-cast aluminum body and polycarbonate diffuser
- \_ LiFePO4 high quality battery 3,2V, 8000mAh, 25,6Wh
- \_ 5Wp solar panel
- \_ Charging time: 8 hours
- \_ 2 operating modes
- \_ 15° adjustable panel
- \_ Ground installation spike sold separately



W	K	LUMEN APPARECCHIO lm		VARIANTE	CODICE	EAN	
7,5	4000	1200	120	-	<b>YUMA1200P</b>	8031453031190	1/4
Picchetto per YUMA350P e YUMA1200P / Ground spike for YUMA350P and YUMA1200P					<b>YUMASPIKE</b>	8031453031305	1
Batteria LiFePO4 18730 4 celle 3,2V 8000mAh per YUMA1200P					<b>B234032080A</b>	8031453033675	1

**FUNZIONAMENTO**

Premere il tasto per accendere il proiettore e passare da una modalità di funzionamento all'altra. Nel passaggio da una modalità all'altra l'apparecchio viene spento. Le due modalità di funzionamento sono: "modalità sensore" e "modalità luce costante". In tutte le modalità il proiettore si spegne automaticamente dopo 12 ore di accensione.

**MODALITÀ SENSORE:** dopo il tramonto, quando viene rilevato movimento l'apparecchio si accende al 100% dell'emissione luminosa. Dopo 20 secondi dall'ultimo movimento rilevato passa al 5% di emissione luminosa.

**MODALITÀ LUCE COSTANTE:** il sensore di movimento è disabilitato. Dopo il tramonto, l'apparecchio emetterà luce costante al 25% di emissione luminosa.

**OPERATION**

Press the button to turn on the projector and switch between operating modes. When switching from one mode to another, the appliance is switched off. The two modes of operation are: "sensor mode" and "constant light mode". In all modes, the projector will automatically turn off after 12 hours of power-on.

**SENSOR LIGHTING MODE:** after sunset, when motion is detected, the fixture switches on at 100% of the light output. After 20 seconds from the last motion detected, it switches to 5% light output.

**CONSTANT LIGHTING MODE:** the motion sensor is disabled. After sunset, the fixture will emit constant light at 25% light output.

# CLAY

BTL CATEGORIA SCONTO 24

Applique solare / Solar wall lamp

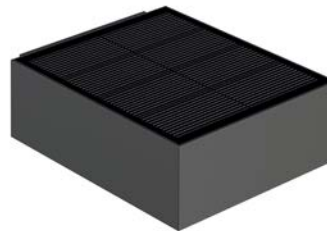
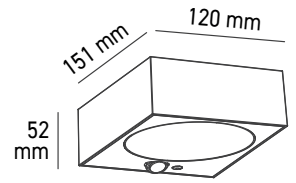

- \_ Applique da parete in policarbonato per esterni con sensore crepuscolare e rilevatore di presenza PIR
- \_ Facile installazione: non richiede collegamenti alla rete elettrica
- \_ Batteria Li-ION 18650, 3.7V, 2000mAh, 7.4Wh
- \_ Pannello solare 2Wp
- \_ Tempo di ricarica: 5 ore
- \_ Materiale ABS + PC anti UV , autoestinguento
- \_ 4 modalità di funzionamento

- \_ *Outdoor polycarbonate wall light with dusk sensor and PIR presence detector*
- \_ *Easy installation: mains connection not needed*
- \_ *High quality Li-ION 18650 battery, 3.7V, 2000mAh, 7.4Wh*
- \_ *2Wp solar panel*
- \_ *Charging time: 5 hours*
- \_ *Self-extinguishing ABS + PC anti UV material*
- \_ *4 working mode*



W	K	LUMEN APPARECCHIO lm		VARIANTE	CODICE	EAN	
5,2	3000	1000	120°	NERO / BLACK	<b>CLAYN2</b>	8031453033088	1/24
5,2	4000	1000	120°	NERO / BLACK	<b>CLAYN</b>	8031453033071	1/24
Batteria Li-ION 18650 1 cella 3.7V 2000mAh per CLAY MOON YUCCA YUCCAP					<b>B111037020A</b>	8031453033484	1

**FUNZIONAMENTO**

Premere il tasto in maniera prolungata per circa 2 secondi per agire su accensione e spegnimento del proiettore. Effettuare una pressione singola per passare da una modalità di funzionamento alla successiva. Alla prima accensione l'apparecchio si accenderà in modalità 1.

Programmazione flusso luminoso: in qualsiasi modalità, premere due volte rapidamente il pulsante. L'apparecchio lampeggerà due volte per segnalare l'ingresso in modalità flusso luminoso programmabile.

In questa modalità, ad ogni pressione del pulsante il flusso luminoso dell'apparecchio aumenterà del 10% dallo 0% al 100% per poi ricominciare da 0%. In base alla modalità di funzionamento in uso al momento della programmazione del flusso luminoso, cambierà il parametro che verrà modificato come indicato nel funzionamento delle singole modalità.

Per uscire dalla modalità è necessario non premere il pulsante per 5 secondi, l'apparecchio lampeggerà velocemente per 3 volte a conferma dell'uscita dalla modalità luminosità programmabile.

Per resettare le impostazioni di default tenere premuto il pulsante per 6 secondi, l'apparecchio lampeggerà velocemente per 5 volte a conferma dell'avvenuto reset e si setterà in modalità 1.

**MODALITÀ 1:** Il proiettore rimarrà acceso al 20% di emissione dal tramonto all'alba o fino ad esaurimento della carica della batteria. La modalità di programmazione del flusso luminoso porterà ad un aumento del 10% ad ogni pressione del tasto.

**MODALITÀ 2:** Il proiettore rimarrà acceso al 10% di emissione dal tramonto all'alba o fino ad esaurimento della carica della batteria. Quando verrà rilevato un movimento nel raggio di 1-5 metri si accenderà al 100% dell'emissione e rimarrà acceso per 30 secondi successivi all'ultimo movimento rilevato per poi tornare al 10% di emissione. La modalità di programmazione del flusso luminoso permetterà di aumentare del 10% ad ogni pressione del tasto il flusso relativo all'accensione nel caso di rilevamento di presenza.

**MODALITÀ 3:** Il proiettore rimarrà spento. Quando, tra il tramonto e l'alba, verrà rilevato un movimento nel raggio di 1-5 metri si accenderà al 100% dell'emissione e rimarrà acceso per 30 secondi successivi all'ultimo movimento rilevato per poi spegnersi nuovamente. La modalità di programmazione del flusso luminoso permetterà di aumentare del 10% ad ogni pressione del tasto il flusso relativo alla funzione fissa finché non avviene il rilevamento di presenza.

**MODALITÀ 4:** Il proiettore rimarrà acceso al 100% di emissione dal tramonto all'alba o fino ad esaurimento della carica della batteria. La modalità di programmazione del flusso luminoso porterà ad un aumento del 10% ad ogni pressione del tasto.



**CLAY**



**OPERATION**

Press and hold the button for about 2 seconds to turn the projector on or off. Press the button once to switch to the next operating mode. Upon first activation, the device will start in Mode 1.

**Light Flow Programming:** In any mode, press the button twice quickly. The device will flash twice to indicate entry into the programmable light flow mode. In this mode, each press of the button will increase the light flow by 10%, from 0% to 100%, and then restart from 0%. Depending on the operating mode active at the time of light flow programming, the parameter being adjusted will change as described in the operation of each mode.

To exit the mode, do not press the button for 5 seconds; the device will flash quickly 3 times to confirm the exit from the programmable brightness mode.

To reset the default settings, press and hold the button for 6 seconds; the device will flash quickly 5 times to confirm the reset and will set itself to Mode 1.

**MODE 1:** the projector will remain on at 20% brightness from sunset to sunrise or until the battery is fully discharged. The light flow programming mode will increase brightness by 10% with each press of the button.

**MODE 2:** the projector will remain on at 10% brightness from sunset to sunrise or until the battery is fully discharged. When motion is detected within a range of 1-5 meters, it will turn on at 100% brightness and remain on for 30 seconds after the last detected motion before returning to 10% brightness. The light flow programming mode will allow an increase of 10% with each press of the button for the brightness level activated upon motion detection.

**MODE 3:** the projector will remain off. When motion is detected within a range of 1-5 meters between sunset and sunrise, it will turn on at 100% brightness and remain on for 30 seconds after the last detected motion before turning off again. The light flow programming mode will allow an increase of 10% with each press of the button for the fixed brightness level until motion is detected.

**MODE 4:** the projector will remain on at 100% brightness from sunset to sunrise or until the battery is fully discharged. The light flow programming mode will increase brightness by 10% with each press of the button.

# AVENUE

BTL CATEGORIA SCONTO 24

Applique solare / Solar wall lamp

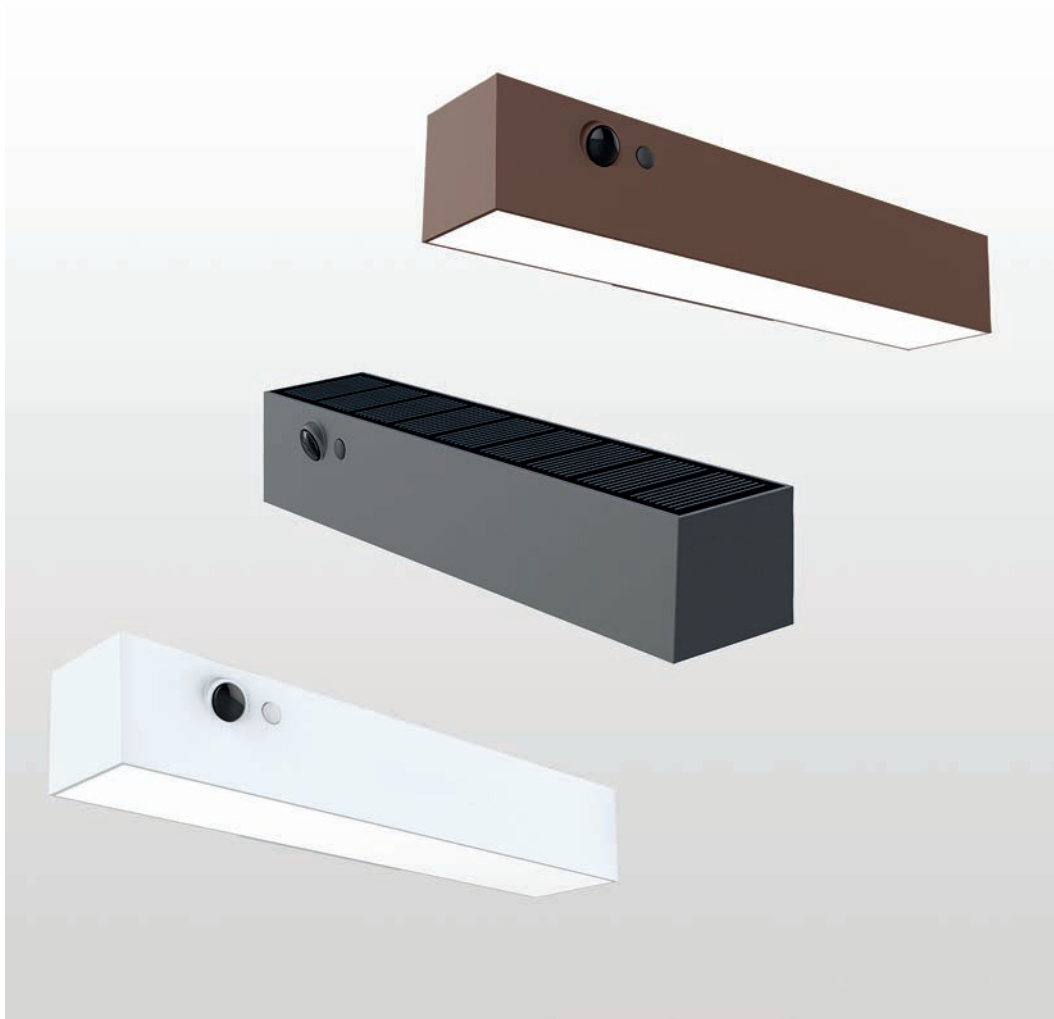
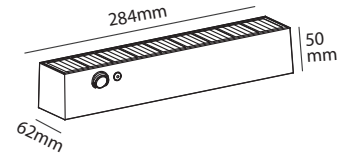

- \_ Applique da parete in policarbonato per esterni con sensore crepuscolare e rilevatore di presenza PIR
- \_ Facile Installazione: non richiede collegamenti alla rete elettrica
- \_ Batteria Li-ION 18650, 3.7V, 2000mAh, 7.4Wh
- \_ Pannello solare 1,5Wp
- \_ Tempo di ricarica: 6 ore
- \_ 4 modalità di funzionamento

- \_ *Outdoor polycarbonate wall light with dusk sensor and PIR presence detector*
- \_ *Easy installation: mains connection not needed*
- \_ *Li-ION 18650 battery, 3.7V, 2000mAh, 7.4Wh*
- \_ *1,5Wp solar panel*
- \_ *Charging time: 6 hours*
- \_ *4 working mode*



W	K	LUMEN APPARECCHIO lm		VARIANTE	CODICE	EAN		
5,2		3000	1000	120°	BIANCO / WHITE	<b>AVENUEB2</b>	8031453032029	1/36
5,2		4000	1000	120°	BIANCO / WHITE	<b>AVENUEB</b>	8031453030995	1/36
5,2		3000	1000	120°	NERO / BLACK	<b>AVENUEB2</b>	8031453032043	1/36
5,2		4000	1000	120°	NERO / BLACK	<b>AVENUEB</b>	8031453031008	1/36
5,2		3000	1000	120°	CORTEN	<b>AVENUEC2</b>	8031453032036	1/36
5,2		4000	1000	120°	CORTEN	<b>AVENUEC</b>	8031453031015	1/36

**FUNZIONAMENTO**

Premere il tasto in maniera prolungata per circa 2 secondi per agire su accensione e spegnimento del proiettore. Premerlo nuovamente per passare da una modalità di funzionamento ad un'altra. Alla prima accensione l'apparecchio si accenderà in modalità 1.

MODALITÀ 1: Il proiettore rimarrà acceso al 100% di emissione dal tramonto all'alba o fino ad esaurimento della carica della batteria.

MODALITÀ 2: Il proiettore rimarrà acceso al 25% di emissione dal tramonto all'alba o fino ad esaurimento della carica della batteria.

MODALITÀ 3: Il proiettore rimarrà acceso al 10% di emissione dal tramonto all'alba o fino ad esaurimento della carica della batteria. Quando verrà rilevato un movimento nel raggio di 1-5 metri si accenderà al 100% dell'emissione e rimarrà acceso per 30 secondi successivi all'ultimo movimento rilevato.

MODALITÀ 4: Il proiettore rimarrà spento. Quando verrà rilevato un movimento nel raggio di 1-5 metri si accenderà al 100% dell'emissione e rimarrà acceso per 30 secondi successivi all'ultimo movimento rilevato.

**OPERATION**

Press the button for about 2 seconds to turn the projector on and off. Press it again to switch between operating modes. When the appliance is first switched on, it will turn on in mode 1.

*MODE 1: The projector will remain on at 100% emission from dusk to dawn or until depletion of battery power.*

*MODE 2: The projector will remain on at 25% emission from dusk to dawn or until depletion of battery power.*

*MODE 3: The projector will remain on at 10% emission from dusk to dawn or until depletion of battery power. When motion within 1-5 meters is detected, it will light up at 100% of the emission and remain on for 30 seconds following the last detected movement.*

*MODE 4: The projector will remain off. When motion within 1-5 meters is detected, it will light up at 100% of the emission and remain on for 30 seconds following the last detected movement.*

# MOON

BTL CATEGORIA SCONTO 24

Applique solare / Solar wall lamp

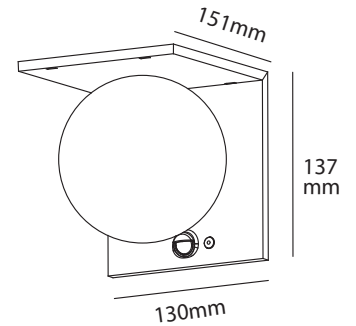

- \_ Applique da parete in policarbonato per esterni con sensore crepuscolare e rilevatore di presenza PIR
- \_ Facile Installazione: non richiede collegamenti alla rete elettrica
- \_ Batteria Li-ION 18650, 3,7V, 2000mAh, 7,4Wh
- \_ Pannello solare 1,5Wp
- \_ Tempo di ricarica: 6 ore
- \_ 4 modalità di funzionamento

- \_ *Outdoor polycarbonate wall light with dusk sensor and PIR presence detector*
- \_ *Easy installation: mains connection not needed*
- \_ *Li-ION 18650 battery, 3,7V, 2000mAh, 7,4Wh*
- \_ *1,5Wp solar panel*
- \_ *Charging time: 6 hours*
- \_ *4 working mode*



W	K	LUMEN APPARECCHIO lm		VARIANTE	CODICE	EAN		
5,2		3000	1000	270°	BIANCO / WHITE	<b>MOONB2</b>	8031453032050	1/18
5,2		4000	1000	270°	BIANCO / WHITE	<b>MOONB</b>	8031453031152	1/18
5,2		3000	1000	270°	NERO / BLACK	<b>MOONN2</b>	8031453032067	1/18
5,2		4000	1000	270°	NERO / BLACK	<b>MOONN</b>	8031453031022	1/18
Batteria Li-ION 18650 1 cella 3,7V 2000mAh per CLAY MOON YUCCA YUCCAP					<b>B111037020A</b>	8031453033484	1	



### FUNZIONAMENTO

Premere il tasto in maniera prolungata per circa 2 secondi per agire su accensione e spegnimento del proiettore. Premerlo nuovamente per passare da una modalità di funzionamento ad un'altra. Alla prima accensione l'apparecchio si accenderà in modalità 1.

MODALITÀ 1: Il proiettore rimarrà acceso al 100% di emissione dal tramonto all'alba o fino ad esaurimento della carica della batteria.

MODALITÀ 2: Il proiettore rimarrà acceso al 25% di emissione dal tramonto all'alba o fino ad esaurimento della carica della batteria.

MODALITÀ 3: Il proiettore rimarrà acceso al 10% di emissione dal tramonto all'alba o fino ad esaurimento della carica della batteria. Quando verrà rilevato un movimento nel raggio di 1-5 metri si accenderà al 100% dell'emissione e rimarrà acceso per 30 secondi successivi all'ultimo movimento rilevato.

MODALITÀ 4: Il proiettore rimarrà spento. Quando verrà rilevato un movimento nel raggio di 1-5 metri si accenderà al 100% dell'emissione e rimarrà acceso per 30 secondi successivi all'ultimo movimento rilevato.

### OPERATION

Press the button for about 2 seconds to turn the projector on and off. Press it again to switch between operating modes. When the appliance is first switched on, it will turn on in mode 1.

*MODE 1: The projector will remain on at 100% emission from dusk to dawn or until depletion.*

*MODE 2: The projector will remain on at 25% emission from dusk to dawn or until depletion of battery power.*

*MODE 3: The projector will remain on at 10% emission from dusk to dawn or until depletion of battery power. When motion within 1-5 meters is detected, it will light up at 100% of the emission and remain on for 30 seconds following the last detected movement.*

*MODE 4: The projector will remain off. When motion within 1-5 meters is detected, it will light up at 100% of the emission and remain on for 30 seconds following the last detected movement.*

# YUCCA

BTL CATEGORIA SCONTO 24

## Lanterna solare / Solar lantern

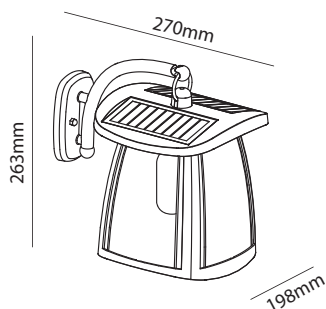

- \_ Lanterna appendibile in policarbonato per esterni con sensore crepuscolare
- \_ Facile Installazione: non richiede collegamenti alla rete elettrica
- \_ Batteria Li-ION 18650, 3.7V, 2000mAh, 7.4Wh
- \_ Pannello solare 2Wp
- \_ Tempo di ricarica: 5 ore
- \_ 4 modalità di funzionamento
- \_ Sorgente 3000K opzionale

### FUNZIONAMENTO

Premere il tasto in maniera prolungata per circa 1,5 secondi per agire su accensione e spegnimento del proiettore. Premerlo nuovamente per passare da una modalità di funzionamento ad un'altra.

MODALITÀ 1: Il proiettore rimarrà acceso al 25% di emissione dal tramonto all'alba, o fino all'esaurimento della batteria.

MODALITÀ 2: Il proiettore rimarrà acceso al 50% di emissione dal tramonto all'alba, o fino all'esaurimento della batteria.

MODALITÀ 3: Il proiettore rimarrà acceso al 75% di emissione dal tramonto all'alba, o fino all'esaurimento della batteria.

MODALITÀ 4: Il proiettore rimarrà acceso al 100% di emissione dal tramonto all'alba, o fino all'esaurimento della batteria.

### OPERATION

Press the button for about 1.5 seconds to turn the projector on and off. Press it again to switch between operating modes.

MODE 1: The projector will remain on at 25% emission from dusk to dawn, or until the battery runs out.

MODE 2: The projector will remain on at 50% emission from dusk to dawn, or until the battery runs out.

MODE 3: The projector will remain on at 75% emission from dusk to dawn, or until the battery runs out.

MODE 4: The projector will remain on at 100% emission from dusk to dawn, or until the battery runs out.

- \_ Outdoor polycarbonate hangable lantern with dusk sensor
- \_ Easy installation: mains connection not needed
- \_ Li-ION 18650 battery, 3.7V, 2000mAh, 7.4Wh
- \_ Solar panel 2Wp
- \_ Charging time: 5 hours
- \_ 4 working mode
- \_ Optional 3000K bulb



W	K	LUMEN APPARECCHIO lm		VARIANTE	CODICE	EAN	
1,8	4000	350	330°	NERO / BLACK	YUCCA	8031453030971	1/4
Lampada Stick per YUCCA 600lm 5V E27 WW - 3000K					YUCCABULB2	8031453032081	1
Lampada Stick per YUCCA 600lm 5V E27 CW - 4000K					YUCCABULB	8031453032074	1
Batteria Li-ION 18650 1 cella 3,7V 2000mAh per CLAY MOON YUCCA YUCCAP					B111037020A	8031453033484	1



**YUCCA**

# YUCCAP

BTL CATEGORIA SCONTO 24

Lanterna solare con paletto / Solar lantern with pole

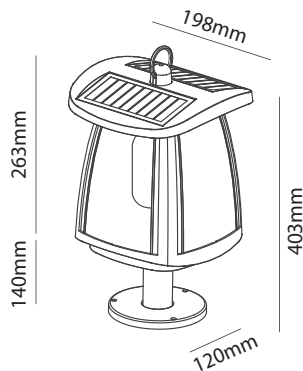

- Lanterna con paletto in policarbonato per esterni con sensore crepuscolare
- Facile Installazione: non richiede collegamenti alla rete elettrica
- Batteria Li-ION 18650, 3.7V, 2000mAh, 7.4Wh
- Pannello solare 2Wp
- Tempo di ricarica: 5 ore
- 4 modalità di funzionamento
- Sorgente 3000K opzionale

## FUNZIONAMENTO

Premere il tasto in maniera prolungata per circa 1,5 secondi per agire su accensione e spegnimento del proiettore. Premerlo nuovamente per passare da una modalità di funzionamento ad un'altra.

MODALITÀ 1: Il proiettore rimarrà acceso al 25% di emissione dal tramonto all'alba, o fino all'esaurimento della batteria.

MODALITÀ 2: Il proiettore rimarrà acceso al 50% di emissione dal tramonto all'alba, o fino all'esaurimento della batteria.

MODALITÀ 3: Il proiettore rimarrà acceso al 75% di emissione dal tramonto all'alba, o fino all'esaurimento della batteria.

MODALITÀ 4: Il proiettore rimarrà acceso al 100% di emissione dal tramonto all'alba, o fino all'esaurimento della batteria.

## OPERATION

Press the button for about 1.5 seconds to turn the projector on and off. Press it again to switch between operating modes.

MODE 1: The projector will remain on at 25% emission from dusk to dawn, or until the battery runs out.

MODE 2: The projector will remain on at 50% emission from dusk to dawn, or until the battery runs out.

MODE 3: The projector will remain on at 75% emission from dusk to dawn, or until the battery runs out.

MODE 4: The projector will remain on at 100% emission from dusk to dawn, or until the battery runs out.

- Outdoor polycarbonate pole lantern with dusk sensor
- Easy installation: mains connection not needed
- Lithium-Ion battery 3.7V, 2000mAh, 7.4Wh
- 2Wp solar panel
- Charging time: 5 hours
- 4 working mode
- Optional 3000K bulb



W	K	LUMEN APPARECCHIO lm		VARIANTE	CODICE	EAN	
1,8	4000	350	330°	NERO / BLACK	YUCCAP	8031453030988	1/4
Lampada Stick per YUCCA 600lm 5V E27 WW - 3000K					YUCCABULB2	8031453032081	1
Lampada Stick per YUCCA 600lm 5V E27 CW - 4000K					YUCCABULB	8031453032074	1
Batteria Li-ION 18650 1 cella 3.7V 2000mAh per CLAY MOON YUCCA YUCCAP					B111037020A	8031453033484	1



**YUCCAP**

# FLAME2N

BTL CATEGORIA SCONTO 24

Torcia a Led effetto fiamma - solare con sensore crepuscolare /  
Led torch with flame effect - solar powered & dusk sensor



**FUNZIONAMENTO**

Due modalità di funzionamento.

Premendo il pulsante di accensione una volta si attiva la modalità A: 25% dell'emissione (0,5W), si accende al crepuscolo ( $\leq 30$  lux) e si spegne all'alba ( $\geq 150$  lux) oppure all'esaurimento della carica.

Premendo il pulsante di accensione una seconda volta si attiva la modalità B: 100% dell'emissione (2W), si accende al crepuscolo ( $\leq 30$  lux) e si spegne all'alba ( $\geq 150$  lux) oppure all'esaurimento della carica.

**OPERATION**

Two selectable working modes.

Pressing the power button once, mode A activates: 0.5W (25% emission), turns on at dusk ( $\leq 30$  lux) and turns off at sunrise ( $\geq 150$  lux) or on low battery.

Pressing the button a second time, mode B activates: 2W (100% emission), turns on at dusk ( $\leq 30$  lux) and turns off at sunrise ( $\geq 150$  lux) or on low battery.

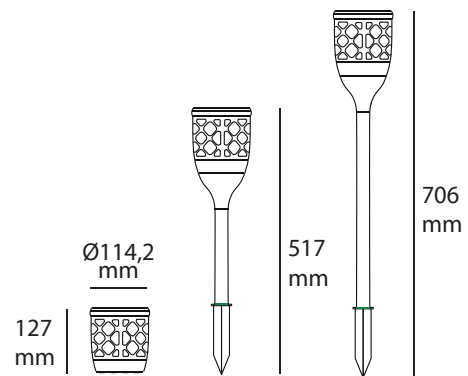

- \_ Effetto fiamma unico e realistico
- \_ Polivalente: adatto sia in giardino che in casa, può essere appeso, appoggiato o posizionato sul paletto in dotazione.
- \_ Due differenti modi di funzionamento
- \_ Ricaricabile tramite pannello solare o porta USB (micro USB)
- \_ Batteria al litio ad alte prestazioni, ampia capacità e lunga durata
- \_ Materiale resistente ai raggi UV ed autoestinguente
- \_ Protezione IP65
- \_ Colore nero

- \_ Unique and realistic flame effect
- \_ Multipurpose: garden and house suited, can be hung, leaned or placed on the included stake
- \_ Two different operating modes
- \_ Rechargeable via solar panel or USB port (micro USB)
- \_ Wide capacity, longer life, high performance lithium battery
- \_ UV-resistant, auto-extinguishing durable material
- \_ IP65 protection
- \_ Black finishing



W	K	LUMEN APPARECCHIO lm		VARIANTE	CODICE	EAN	
2	1500		360°	-	FLAME2N	8031453023232	1/24



**FLAME2N**



**SHOT**  
BOT LIGHTING

**PORTATILI E LEISURE / WORK LIGHTS**  
PORTABLE & LEISURE / WORK LIGHTS

# WORK 50

BTL CATEGORIA SCONTO 24

Lampada da lavoro portatile / Portable worklight

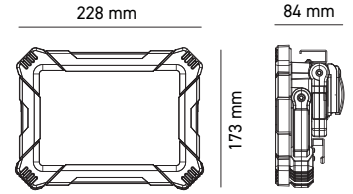

Con 2 prese standard Tedesco 250V 16A VDE /  
With 2 German integrated socket



WORK50 è il proiettore portatile ideale per ogni utilizzo, dai cantieri agli eventi outdoor. Compatto, facile da trasportare e progettato per durare, offre un'illuminazione potente e una luce bianca neutra perfetta per ogni applicazione.

- \_ Proiettore portatile da cantiere con corpo in alluminio
- \_ Due prese standard tedesco 250V 16A VDE sul retro del proiettore
- \_ Interruttore a tre posizioni: OFF - 50% - 100%
- \_ Cavo H07RN-F3G1.5mm<sup>2</sup>, lunghezza 3 metri

WORK50 is the ideal portable projector for any use, from construction sites to outdoor events. Compact, easy to transport, and built to last, it provides powerful illumination and a neutral white light perfect for any application.

- \_ Portable worksite worklight with aluminum body
- \_ Two German standard 250V 16A VDE sockets on the back of the worklight
- \_ Three-position switch: OFF - 50% - 100%
- \_ H07RN-F3G1.5mm<sup>2</sup> cable, 3 meters in length



W	K	LUMEN APPARECCHIO lm	LUMEN SORGENTE lm		VARIANTE	CODICE	EAN		
50	<input type="checkbox"/> 4000	4500	5500	120°	-	WORK50	8031453032746	1/6	



**WORK 50**

# WORK 10

BTL CATEGORIA SCONTO 24

Proiettore portatile / Worklight

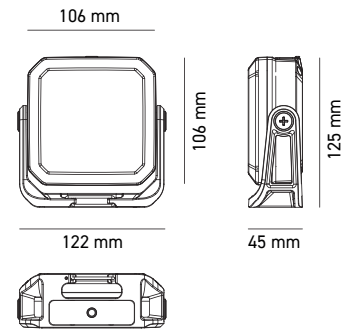

Pannello solare / solar powered



Moschettone integrato / Integrated carabiner



Base magnetica / Magnetic base

Ricaricabile, versatile e resistente, luminosità regolabile e tre tonalità di luce. Il compagno ideale per ogni cantiere o attività outdoor.

- \_ Proiettore portatile da cantiere con ricarica USB e solare (cavo USB-C 1m incluso)
- \_ Batteria alta qualità Li-Ion 18650, 3.7V, 4400mAh, 16.28Wh
- \_ Tripla potenza selezionabile: 25% - 50% - 100%
- \_ Tempo di ricarica 6 ore
- \_ Tempo di funzionamento da 3 a 12 ore (a seconda della dimmerazione)
- \_ Indicatore LED sullo stato di carica della batteria
- \_ Funzione powerbank 5V 2A
- \_ Possibilità di fissaggio: treppiede, gancio o base magnetica

Rechargeable, versatile, and durable, with adjustable brightness and three light tones. The perfect companion for any construction site or outdoor activity.

- \_ Portable worksite projector with USB and solar charging (1m USB-C cable included)
- \_ High quality Li-Ion 18650 battery, 3.7V, 4400mAh, 16.28Wh
- \_ Triple selectable power: 25% - 50% - 100%
- \_ Charging time: 6 hours
- \_ Operating time: 3 to 12 hours (depending on dimming level)
- \_ LED indicator for battery charge status
- \_ 5V 2A powerbank function
- \_ Mounting options: tripod, hook, or magnetic base



W	K	LUMEN APPARECCHIO lm	LUMEN SORGENTE lm		VARIANTE	CODICE	EAN	
10	<ul style="list-style-type: none"> <li><span style="display: inline-block; width: 10px; height: 10px; background-color: yellow; border: 1px solid black; margin-right: 5px;"></span> 3000</li> <li><span style="display: inline-block; width: 10px; height: 10px; background-color: white; border: 1px solid black; margin-right: 5px;"></span> 4000</li> <li><span style="display: inline-block; width: 10px; height: 10px; background-color: lightblue; border: 1px solid black; margin-right: 5px;"></span> 6000</li> </ul>	1000	1250	120°	-	<b>WORK10SUN</b>	8031453032753	1/30

Batteria LI-ION 18650 2 celle 3,7V 4400mAh per WORK10SUN

**B112037044A**

8031453033576

1

# WORK 20

BTL CATEGORIA SCONTO 24

Lampada da lavoro portatile / Portable worklight

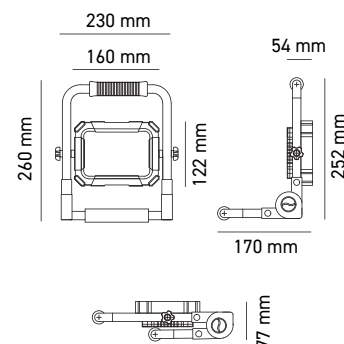

WORK20E unisce potenza e praticità, perfetto per ambienti di lavoro impegnativi grazie alla sua struttura resistente. Ricaricabile tramite USB-C e dotato di funzione powerbank, è pieghevole per un facile trasporto e un ingombro minimo.

WORK20E combines power and practicality, perfect for demanding work environments thanks to its durable structure. Rechargeable via USB-C and equipped with a powerbank function, it is foldable for easy transport and minimal storage space.

- \_ Proiettore portatile da cantiere con ricarica USB (cavo USB-C 1m incluso)
- \_ Batteria alta qualità Li-Ion 18650, 3.7V, 8800mAh, 32.56Wh
- \_ Doppia potenza selezionabile: 50% - 100%
- \_ Tempo di ricarica 6 ore
- \_ Tempo di funzionamento da 3 a 6 ore (a seconda della dimmerazione)
- \_ Indicatore LED sullo stato di carica della batteria
- \_ Funzione powerbank 5V 2A

- \_ Portable worksite projector with USB charging (1m USB-C cable included)
- \_ High quality Li-Ion 18650 battery, 3.7V, 8800mAh, 32.56Wh
- \_ Selectable dual power: 50% - 100%
- \_ Charging time 6 hours
- \_ Operating time from 3 to 6 hours (depending on dimming)
- \_ LED indicator for battery charge status
- \_ Power bank function 5V 2A



W	K	LUMEN APPARECCHIO lm	LUMEN SORGENTE lm		VARIANTE	CODICE	EAN	
20	<input type="checkbox"/> 4000	2000	2500	120°	-	WORK20E	8031453032760	1/8

Batteria LI-ION 18650 4 celle 3.7V 8800mAh per WORK20E

**B114037088A**

8031453033583

1

# FROG

BTL CATEGORIA SCONTO 16

Proiettore multiuso ricaricabile / Rechargeable multipurpose worklight

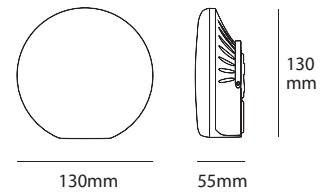

**IDEALE PER / IDEAL FOR**  
  
**ATTIVITÀ ALL'APERTO O HOBBY**  
OUTDOOR OR HOBBY

- \_ Lampada portatile a batteria IP54
- \_ Compatta e leggera, facile da trasportare
- \_ Completa di cavo di alimentazione USB-C da 0,5m (alimentatore non incluso)
- \_ Temperatura colore, intensità luminosa e funzione SOS controllabili tramite tasti dedicati
- \_ Tempo di ricarica 3 ore
- \_ Tempo di funzionamento da 7 a 16 ore (a seconda della dimmerazione)
- \_ Indicatore led sullo stato di carica della batteria
- \_ Funzione powerbank 5V 2A
- \_ Portable battery-powered lamp IP54
- \_ Compact and lightweight, easy to carry
- \_ Supplied with 0,5m USB-C power cable (power adapter not included)
- \_ Color temperature, light intensity and SOS function easily settable with dedicated buttons
- \_ Charging time 3 hours
- \_ Operating time from 7 to 16 hours (depending on dimming)
- \_ LED indicator for battery charge status
- \_ Power bank function 5V 2A



W	K	LUMEN APPARECCHIO lm	LUMEN SORGENTE lm		VARIANTE	CODICE	EAN	
4	<input type="checkbox"/> 3000 <input type="checkbox"/> 4000 <input type="checkbox"/> 6000	510	530	200°	-	FROG	8031453031435	1/20

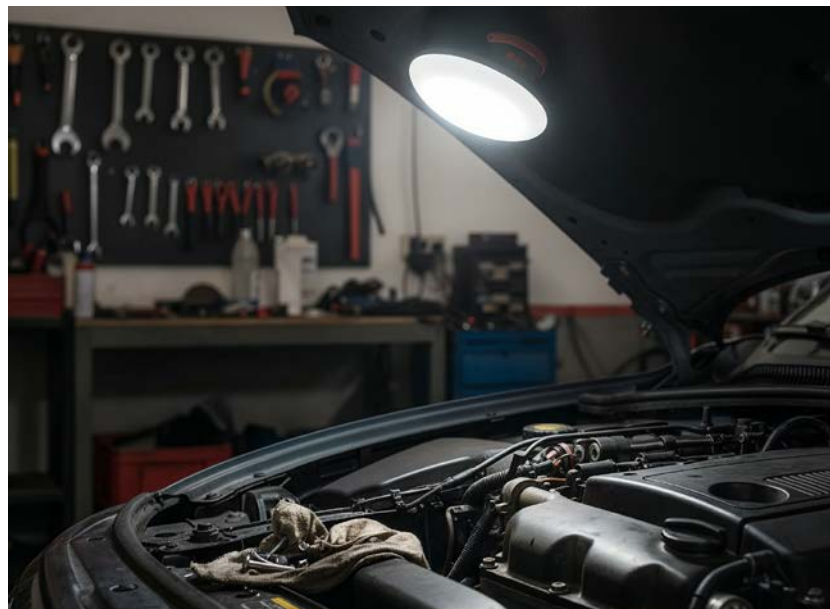

**FROG**

# LED16

BTL CATEGORIA SCONTO 16

Flashlight torcia portatile a led ricaricabile / Portable Rechargeable LED Torch

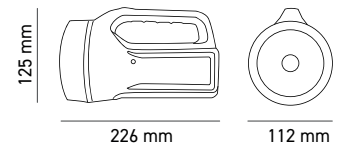

Incluso cavo di ricarica  
Charging cable included

- \_ Interruttore a due posizioni
- \_ Batteria Li-ION 18650, 3.7V, 4000mAh, 16Wh
- \_ Tempo di ricarica 12-15 ore
- \_ Tempo di funzionamento da 5 a 10 ore
- \_ Pratica cinghia tracolla
- \_ Caricabatterie da rete integrato nel corpo lampada

- \_ *Two-position switch*
- \_ *High quality Li-ION 18650 battery, 3.7V, 4000mAh, 16Wh*
- \_ *12-15 hours charging time*
- \_ *Operating time from 5 to 10 hours*
- \_ *Practical shoulder strap*
- \_ *Mains charger integrated into the lamp body*



W		VARIANTE	CODICE	EAN	
5	-	-	LED16X	8031453033101	1/10

# TORCIA DA LAVORO

NEW

BTL CATEGORIA SCONTO 16

## PORTABLE WORKLIGHT

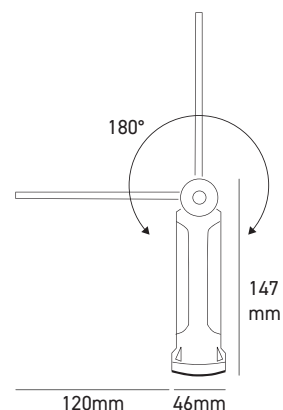
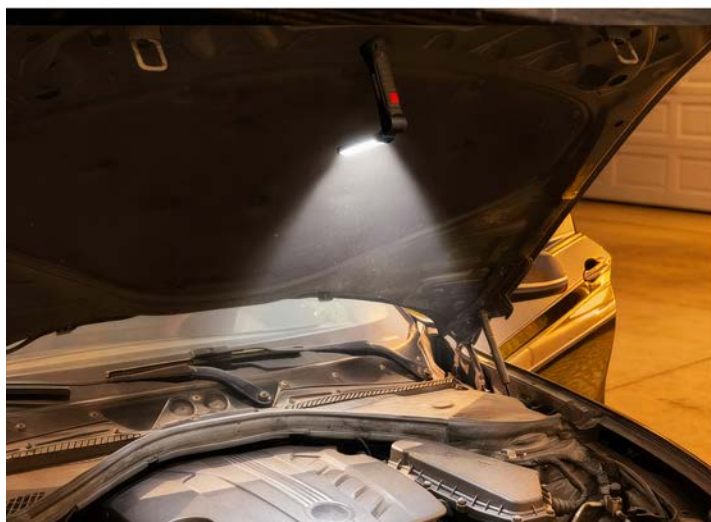

- \_ Lampada da lavoro con base magnetica
- \_ Orientabile fino a 180°
- \_ 5 modalità: pressione singola 100% / 350lm, 50%, luce di precisione - pressione prolungata luce rossa, luce rossa intermittente
- \_ 350lm al 100%
- \_ Corpo in gomma antiscivolo
- \_ Tempo di ricarica 4 ore
- \_ Autonomia 3 ore al 100%, varia in base alla modalità utilizzata
- \_ Batteria Li-ION 18650 1200mAh
- \_ Ricaricabile tramite USB-C (cavo non incluso)

- \_ Work light with magnetic base
- \_ Adjustable up to 180°
- \_ 5 modes: single press 100%, 50%, precision light; long press red light, flashing red light
- \_ 350lm at 100%
- \_ Non-slip rubber body
- \_ Charging time: 4 hours
- \_ Runtime: 3 hours at 100%; varies depending on the selected mode
- \_ Li-ION 18650 battery, 1200mAh
- \_ USB-C rechargeable (cable not included)

IP 20

CODICE

EAN



WORK-M

8031453035396

1/50

**SHOT**  
BOT LIGHTING

**FLASHLIGHTS & SPORTS LIGHTS**







## KIT LUCI DA BICI

NEW

BTL CATEGORIA SCONTO 16

- \_ Kit luce anteriore + posteriore multiuso per biciclette
  - \_ Luce frontale 600lm - 3 step di regolazione 100/60/30% + intermittente rapida e intermittente lenta
  - \_ Luce posteriore 150lm - 2 step di regolazione 100/50% + intermittente
  - \_ Tempo di ricarica: luce frontale 3h, posteriore 3h
  - \_ Autonomia luce frontale e posteriore: al 100% 3h, varia in base alla modalità utilizzata
  - \_ Luce frontale con indicatore di carica residua percentuale
  - \_ Batteria: luce frontale Li-Poly 1200mAh, luce posteriore Li-Poly 200mAh
  - \_ Ricaricabile tramite USB-C (cavo non incluso)
- \_ Multi-purpose front and rear light kit for bicycles
  - \_ Front light 600lm - 3 brightness levels: 100/60/30% + fast flashing and slow flashing
  - \_ Rear light 150lm - 2 brightness levels: 100/50% + flashing
  - \_ Charging time: front light 3h, rear light 3h
  - \_ Front and rear light runtime: 3h at 100%; varies depending on the selected mode
  - \_ Front light with remaining battery charge percentage indicator
  - \_ Battery: front light Li-Poly 1200mAh, rear light Li-Poly 200mAh
  - \_ USB-C rechargeable (cable not included)

IP 44

CODICE

EAN

IMBALLO

BIKIT

8031453035402

1/50



## HEADLIGHT

NEW

BTL CATEGORIA SCONTO 16

- \_ Lampada da testa con inclinazione regolabile
  - \_ 5 modalità: luce fissa fascio stretto 100%, 50%, intermittente, luce fissa fascio largo 100%, luce rossa/blu intermittente 100lm al 100%
  - \_ Tempo di ricarica 3 ore
  - \_ Autonomia 3 ore al 100%, varia in base alla modalità utilizzata
  - \_ Batteria Li-ION 14500 300mAh
  - \_ Ricaricabile tramite USB-C (cavo non incluso)
- \_ Headlamp with adjustable tilt angle
  - \_ 5 lighting modes: narrow beam steady light at 100% and 50%, flashing mode, wide beam steady light at 100%, flashing red/blue light 100lm at full power
  - \_ Charging time: 3 hours
  - \_ Runtime: 3 hours at 100%, depending on the selected mode
  - \_ 300mAh Li-ion 14500 battery
  - \_ USB-C rechargeable (cable not included)

IP 20

CODICE

EAN

IMBALLO

HEAD

8031453035358

1/100



## AIRAM POWER HEADLIGHT

BTL CATEGORIA SCONTO 16

- \_ Lampada headlight con inclinazione regolabile
  - \_ Funzioni: luce bianca al 100% - luce bianca al 40% - luce rossa al 100% e luce rossa intermittente
  - \_ Durata fino a 30.000h
  - \_ 3W - 200lm CREE led, non intercambiabile
  - \_ Batterie: 3XLR03 (non include)
- \_ Headlight lamp with adjustable inclination
  - \_ Functions: 100% white light - 40% white light - 100% red light and flashing red light
  - \_ Duration up to 30,000h
  - \_ 3W - 200lm CREE led, not interchangeable
  - \_ Batteries: 3XLR03 (not included)

IP 20

CODICE

EAN

IMBALLO

LED26

6435200204301

6/24



## HEADLIGHT CON SENSORE

NEW

BTL CATEGORIA SCONTO 16



- \_ Lampada da testa
- \_ Funzione tramite sensore attivabile con l'apposito tasto. La luce si accende e spegne con il passaggio della mano nella zona del sensore all'altezza delle tempie
- \_ 5 modalità: pressione singola luce frontale 100%, 50%, luce di precisione 100%, 50% - pressione prolungata luce intermittente
- \_ 380lm al 100%
- \_ Tempo di ricarica 5 ore
- \_ Autonomia 3 ore al 100%, varia in base alla modalità utilizzata
- \_ Batteria Li-Poly 1200mAh
- \_ Ricaricabile tramite USB-C (cavo non incluso)
- \_ Headlamp
- \_ Sensor function activated by the dedicated button; the light turns on and off by waving a hand in front of the sensor near the temples
- \_ 5 lighting modes: single press for front light at 100% and 50%, precision light at 100% and 50%; long press for flashing mode
- \_ 380lm at full power
- \_ Charging time: 5 hours
- \_ Runtime: 3 hours at 100%, depending on the selected mode
- \_ 1200mAh Li-poly battery
- \_ USB-C rechargeable (cable not included)

IP 20

CODICE

EAN

IMBALLO

HEAD-W

8031453035341

1/100



## TORCIA LED 500lm

NEW

BTL CATEGORIA SCONTO 16

- \_ Torcia portatile in alluminio e ABS
- \_ 6 modalità: pressione singola 100%, 50%, intermittente - pressione prolungata luce calda laterale, luce rossa laterale, luce rossa laterale intermittente
- \_ 500lm al 100%
- \_ Funzione zoom tramite scorrimento della ghiera
- \_ Tempo di ricarica 4 ore
- \_ Autonomia 3 ore al 100%, varia in base alla modalità utilizzata
- \_ Indicatore LED di carica residua
- \_ Batteria Li-ION 18650 500mAh
- \_ Ricaricabile tramite USB-C (cavo non incluso)
- \_ Portable aluminium and ABS flashlight
- \_ 6 lighting modes: single press for 100%, 50%, and flashing; long press for warm side light, side red light, and flashing side red light
- \_ 500lm at full power
- \_ Zoom function with sliding ring
- \_ Charging time: 4 hours
- \_ Runtime: 3 hours at 100%, depending on the selected mode
- \_ LED battery level indicator
- \_ 500mAh Li-ION 18650 battery
- \_ USB-C rechargeable (cable not included)

IP 44

CODICE

EAN

IMBALLO

FLASH1

8031453035372

1/50



## TORCIA LED 1500lm

NEW

BTL CATEGORIA SCONTO 16

- \_ Torcia portatile in alluminio e ABS con base magnetica
- \_ 6 modalità: pressione singola 100%, 50%, intermittente - pressione prolungata luce calda laterale, luce fredda laterale, luce rossa laterale intermittente
- \_ 1500lm al 100%
- \_ Funzione zoom tramite scorrimento della ghiera
- \_ Funzione powerbank
- \_ Tempo di ricarica 4 ore
- \_ Autonomia 3 ore al 100%, varia in base alla modalità utilizzata
- \_ Indicatore LED di carica residua
- \_ Batteria Li-ION 21700 3000mAh
- \_ Ricaricabile tramite USB-C (cavo non incluso)
- \_ Portable flashlight in aluminium and ABS with magnetic base
- \_ 6 modes: single press 100%, 50%, flashing; long press warm side light, cool side light, flashing red side light
- \_ 1500lm at 100%
- \_ Zoom function by sliding the ring
- \_ Power bank function
- \_ Charging time: 4 hours
- \_ Runtime: 3 hours at 100%; varies depending on the selected mode
- \_ LED battery level indicator
- \_ Li-ION 21700 battery, 3000mAh
- \_ USB-C rechargeable (cable not included)

IP 44

CODICE

EAN

IMBALLO

FLASH2

8031453035389

1/40

## EXPO CLIPPY SAFETY LIGHT LED 12 PZ

BTL CATEGORIA SCONTO 16



- \_ Portachiavi con LED 2W - 40lm
  - \_ Ideale per carrozzine, borse, bastoni o guinzagli per i cani
  - \_ 2 x CR2032 incluse
  - \_ Corpo in plastica
  - \_ Colori blu, rosso, verde o trasparente.
  - \_ Con espositore da 12 pezzi
- \_ Keychain with LED 2W - 40lm
  - \_ Ideal for prams, bags, sticks or dog leashes
  - \_ 2 x CR2032 included
  - \_ Plastic body
  - \_ Blue, red, green or transparent colors
  - \_ With 12 pieces display

**CODICE**

**EAN**

**IMBALLO**

8710503

6435200236869

1/12

## EXPO TORCE LED COLORI VARI 12 PZ

BTL CATEGORIA SCONTO 16



- \_ Torcia in alluminio con impugnatura in gomma
  - \_ Cinturino di sicurezza
  - \_ 1W - 80lm
  - \_ 12 torce (4 rosse - 4 verdi - 4 blu)
  - \_ Batterie: 3xAAA (non incluse)
- \_ Aluminum flashlight with rubber grip
  - \_ Safety strap
  - \_ 1W - 80lm
  - \_ 12 light torches (4 red - 4 green - 4 blue)
  - \_ Batteries: 3xAAA (not included)

**CODICE**

**EAN**

**IMBALLO**

8710490

6435200227737

1/4

## EXPO TORCE LED13 COLORI VARI 12 PZ

BTL CATEGORIA SCONTO 16



- \_ Corpo in gomma
  - \_ Cinturino di sicurezza
  - \_ 12 torce (3 rosse, 3 blu, 3 verdi, 3 nere)
  - \_ Batterie: 3xAAA incluse
- \_ Rubber body
  - \_ Safety strap
  - \_ 12 flashlights (3 red, 3 blue, 3 green, 3 black)
  - \_ Batteries: 3xAAA included

**CODICE**

**EAN**

**IMBALLO**

LED13XKIT

8031453033118

1/4



## EXPO WORKLIGHT LED COLORI VARI 9 PZ

BTL CATEGORIA SCONTO 16

- \_ Lampada da lavoro con staffa magnetica orientabile fino a 180°
  - \_ Funzioni: modalità torcia o modalità lanterna
  - \_ Composizione: 9 torce (3 rosse - 3 nere - 3 blu)
  - \_ Corpo in gomma antisdrucciolo e con gancio per sospensione
  - \_ 3W - 250lm
  - \_ Batterie: 3xAAA (incluse)
- \_ Work lamp with magnetic bracket adjustable up to 180 °
  - \_ Functions: torch mode or lantern mode
  - \_ Composition: 9 light torches (3 red - 3 black - 3 blue)
  - \_ Body in non-slip rubber and with hook for suspension
  - \_ 3W - 250lm
  - \_ Batteries: 3xAAA (included)

**CODICE**

**EAN**

**IMBALLO**

8710478

6435200218827

1/4



## EVOLUTION + ALKALINE

BTL CATEGORIA SCONTO 15



	<b>CODICE</b>	<b>EAN</b>	<b>IMBALLO</b>
Ministilo AAA 1,5V Evolution (BL 4 pz.)	<b>LR03</b>	6435200194725	1/10
Stilo AA 1,5V Evolution (BL 4 pz.)	<b>LR6</b>	6435200194749	1/10
Transistor 9V Evolution (BL 1pz)	<b>6LR61</b>	6435200194763	1/10

## SUPER ALKALINE MULTIPACK

BTL CATEGORIA SCONTO 15



	<b>CODICE</b>	<b>EAN</b>	<b>IMBALLO</b>
Ministilo 1,5V Alkaline (Pack 10 pz.)	<b>LR03/10</b>	6435200275622	1
Ministilo 1,5V Alkaline (Pack 16 pz.)	<b>LR03/16</b>	6435200301383	1
Stilo 1,5V Alkaline (Pack 10 pz.)	<b>LR6/10</b>	6435200275585	1
Stilo 1,5V Alkaline (Pack 16 pz.)	<b>LR6/16</b>	6435200301345	1
1/2 Torcia C 1,5V Evolution (BL 2 pz.)	<b>LR14/2</b>	6435200192431	1
Torcia D 1,5V Evolution (BL 2 pz.)	<b>LR20/2</b>	6435200192455	1
Transistor 9V Evolution (BL 2pz)	<b>6LR61/2</b>	6435200192479	1

## ALKALINE



BTL CATEGORIA SCONTO 15

\_ Per apparecchi fotografici e calcolatori

\_ For cameras and calculators

	<b>CODICE</b>	<b>EAN</b>	<b>IMBALLO</b>
Alkaline AG12/186 1,5V (BI 1 pz)	<b>LR43</b>	6435200138019	1/10
Alkaline A76 1,5V h.5,41 (BI 1 pz)	<b>LR44</b>	6435200138071	1/10
Alkaline LR1130/189 1,5V (BI 1 pz)	<b>LR54</b>	6435200138040	1/10

**SHOT**  
BOT LIGHTING

**LAMPADE NOTTURNE**  
LED NIGHT LIGHTS



### LUCE NOTTURNA POWER LED CREPUSCOLARE 230V

BTL CATEGORIA SCONTO 16



- \_ Luce notturna da presa a basso consumo energetico e lunga durata
- \_ Interruttore automatico crepuscolare, si accende la sera e si spegne al mattino
- \_ Temperatura di colore: 2900K
- \_ 1W - 14lm non intercambiabile
- \_ Low energy consumption and long lasting socket night light
- \_ Twilight automatic switch, turns on in the evening and turns off in the morning
- \_ Color temperature: 2900K
- \_ 1W - 14lm not interchangeable

IP 20

BLISTER

CODICE

EAN

IMBALLO

LED21

6435200173843

5/20

### LUCE NOTTURNA POWER LED CREPUSCOLARE + SENSOR 230V

BTL CATEGORIA SCONTO 16



- \_ Luce notturna da presa a basso consumo energetico e lunga durata
- \_ Interruttore automatico crepuscolare, si accende la sera e si spegne al mattino
- \_ Sensore di movimento, si accende solo quando rileva il passaggio
- \_ Temperatura di colore: 3000K
- \_ 1,8W - 15lm non intercambiabile
- \_ Low energy consumption and long lasting socket night light
- \_ Twilight automatic switch, turns on in the evening and turns off in the morning
- \_ Motion sensor, it turns on only when it detects the passage
- \_ Color temperature: 3000K
- \_ 1,8W - 15lm not interchangeable

IP 20

BLISTER

CODICE

EAN

IMBALLO

LED23

6435200174949

6/48

### LUCE NOTTURNA POWER LED CREPUSCOLARE ROUND 230V

BTL CATEGORIA SCONTO 16



- \_ Luce notturna da presa a basso consumo energetico e lunga durata
- \_ Interruttore automatico crepuscolare, si accende la sera e si spegne al mattino
- \_ Temperatura di colore: 3000K
- \_ 0,4W - 1,5lm non intercambiabile
- \_ Low energy consumption and long lasting socket night light
- \_ Twilight automatic switch, turns on in the evening and turns off in the morning
- \_ Color temperature: 3000K
- \_ 0.4W - 1.5lm not interchangeable

IP 20

BLISTER

CODICE

EAN

IMBALLO

LED24

6435200174956

6/48

### LAMPADA DA ARMADIO CON SENSORE DI MOVIMENTO

BTL CATEGORIA SCONTO 16



- \_ Lampada da armadio in policarbonato ABS con sensore di movimento PIR
- \_ Interruttore ON/OFF
- \_ Dimensioni: larghezza 300mm, lunghezza 45mm
- \_ Temperatura di colore 3000K
- \_ 1,2W - 80lm - 6 LED non intercambiabile
- \_ Batterie: 4 x AA 1,5V (non incluse)
- \_ Wardrobe lamp in ABS polycarbonate with PIR motion sensor
- \_ ON / OFF switch
- \_ Dimensions: width 300mm, length 45mm
- \_ Color temperature: 3000K
- \_ 1,2W - 80lm - 6 non-interchangeable LEDs
- \_ Batteries: 4 x AA 1,5V (not included)

IP 20

BLISTER

CODICE

EAN

IMBALLO

8710464

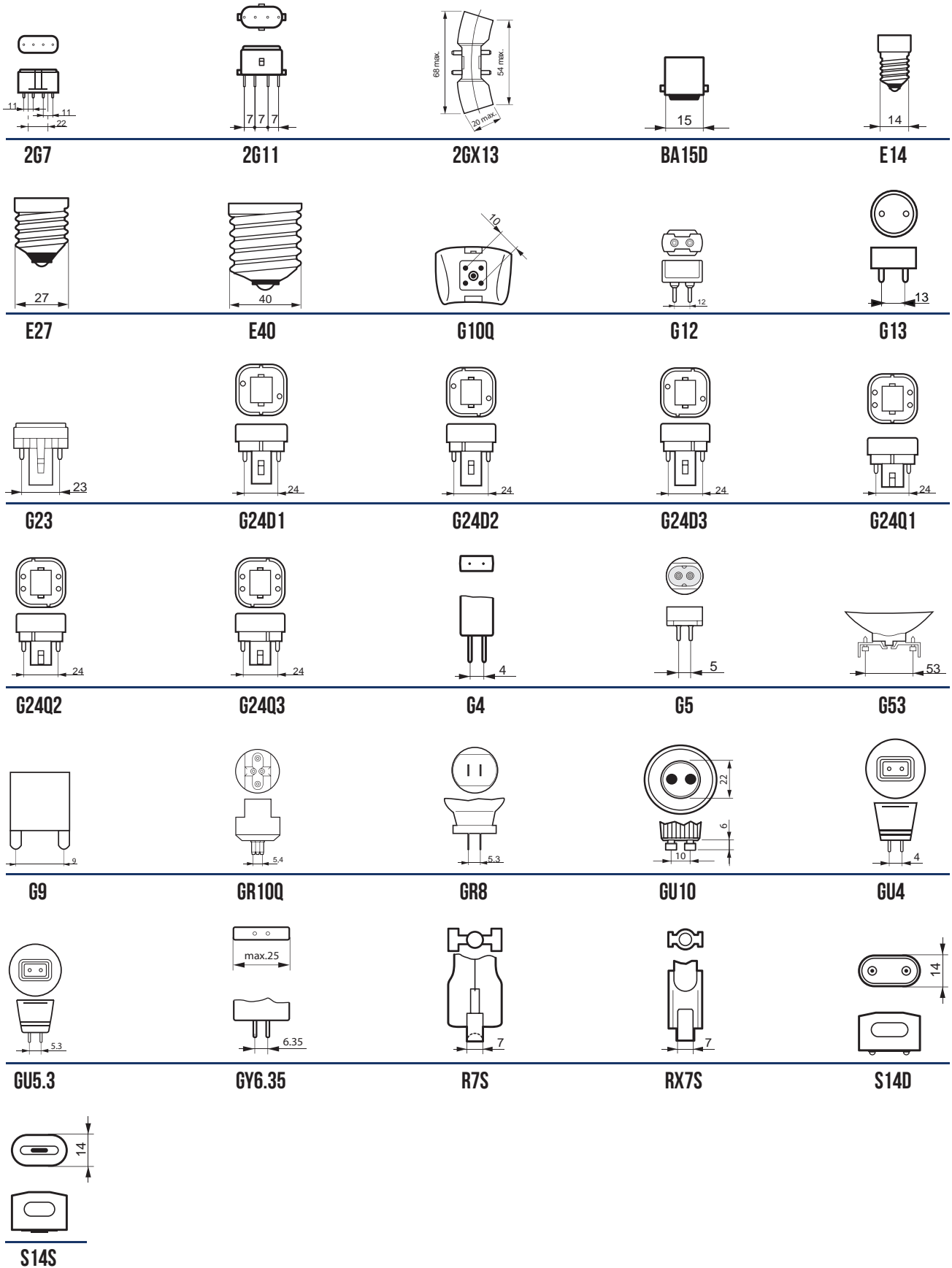

6435200213563

5/40





<b>W=</b> <b>1521</b> LUMEN  360°	<b>EQUIVALENZA CON SORGENTE TRADIZIONALE</b> WATTAGE EQUIVALENT	Il Watt (W) è l'unità di misura della potenza elettrica assorbita. A sinistra è indicato il consumo della lampada mentre a destra è indicato il consumo (maggiore) di una sorgente tradizionale, incandescente od alogena, che produce un flusso luminoso equivalente.	<i>The Watt (W) is the unit of measurement of absorbed electrical power. The consumption of the lamp is indicated to the left, while on the right is the consumption (higher) of a traditional source, whether incandescent or halogen, which produces an equivalent luminous flux.</i>
	<b>AMPIEZZA FASCIO LUMINOSO</b> LIGHT BEAM ANGLE	Nelle lampade con emissione direzionale è indicata l'ampiezza del fascio luminoso espressa in gradi.	<i>In lamps with directional emission the angle of the light beam is given in degrees.</i>
	<b>LUMEN UTILI</b> USEFUL LUMEN	I lumen utili indicano la luce effettivamente emessa da una sorgente luminosa direzionale all'interno di un cono con angolo di apertura specifico: 120° per angoli del fascio > 90° e 90° per angoli del fascio < 90°.	<i>Useful lumens indicate the light effectively emitted by a directional light source within a cone with a specific beam angle: 120° for beam angles &gt; 90° and 90° for beam angles &lt; 90°.</i>
	<b>IMBALLO</b> PACKAGE	Descrive il tipo di confezionamento del prodotto.	<i>Describes the product's type of packaging.</i>
3000 4000 6500	<b>TEMPERATURA GRADI K</b> K TEMPERATURE DEGREES	La temperatura in gradi Kelvin è selezionabile tramite un selettore, che consente di cambiare il colore della luce dell'apparecchio in base alle esigenze.	<i>The temperature in Kelvin degrees is selectable through a selector, allowing the color temperature of the device to be adjusted according to requirements.</i>
	<b>CLASSE ENERGETICA</b> ENERGY CLASS	Mostra l'efficienza energetica dell'apparecchio, basata sulle nuove classi energetiche attuali (da A a G), dove la classe A rappresenta la migliore efficienza con consumi ridotti, mentre la classe G indica un'efficienza molto bassa.	<i>Shows the energy efficiency of the device, based on the new current energy classes (from A to G), where class A represents the highest efficiency with reduced consumption, while class G indicates very low efficiency.</i>
<b>1100 cd</b>	<b>INTENSITA' MAX</b> MAXIMUM INTENSITY	Nelle lampade con emissione direzionale, oltre alla quantità totale di luce emessa (lumen), viene anche indicata l'intensità massima espressa in candele (cd).	<i>In lamps with directional emission, in addition to the total quantity of light emitted (lumen), also the maximum intensity is given in candelas (cd).</i>
	<b>RGB - TUNABLE WHITE</b>	Nelle lampade smart, la funzione RGB consente di cambiare il colore della luce, mentre la funzione Tunable White permette di regolare la temperatura colore (espressa in gradi Kelvin) da luce fredda a luce calda.	<i>In smart lamps, the RGB function allows changing the light color, while the Tunable White function enables adjusting the color temperature (measured in Kelvin) from cool to warm light.</i>
WARM WHITE 4000K COOL WHITE DAY LIGHT	<b>COLORE DELLA LUCE</b> LIGHT COLOUR	Una luce bianca viene caratterizzata dalla Temperatura di colore, espressa in Kelvin (K). La CCT viene espressa in gradi Kelvin; una luce calda si aggira sui 2700 K, un bianco neutro intorno ai 4000 K e un bianco freddo ai 5000 K o più. L'imballo riporta sia la descrizione sia la scala graduata con il valore esatto.	<i>A white light is characterised by the Colour Temperature, given in Kelvin (K). CCT is expressed in degrees Kelvin; a warm light is around 2700 K, a neutral white around 4000 K and a cool white at 5000 K or more. The packaging gives both the description and the graduated scale with the exact value.</i>
	<b>GRADO DI PROTEZIONE IP</b> INGRESS PROTECTION IP	Apparecchio con grado di protezione agli agenti esterni X (es: corpi solidi) e all'umidità Y (es: penetrazione liquidi) es valori da: IP20 (prodotto da interni) /44/65 (prodotto da esterni)...	<i>Luminaire with degree of protection against external agents X (eg: solid bodies) and moisture Y (eg: penetration of liquids) eg. values from IP20 (product for interiors) to IP44, IP65 (outdoor products)...</i>
	<b>GRADO DI PROTEZIONE IMPATTI MECCANICI</b> DEGREE OF PROTECTION MECHANICAL IMPACTS	Il grado di protezione IK è il grado di protezione contro gli impatti meccanici esterni. Con questa classificazione si identifica il grado di robustezza dell'apparecchio. Valori bassi da IK01 (impatto di 0,14 joule) ad alti valori IK10 (impatto pari a 20 joule).	<i>The IK degree of protection is the degree of protection against external mechanical impacts. This classification identifies the degree of robustness of the appliance. Low IK01 values (impact of 0.14 joules) to high IK10 values (impact of 20 joules).</i>
<b>220-240V</b>	<b>ALIMENTAZIONE</b> MAINS	Range tensione collegamento a alla rete elettrica.	<i>Connection mains Voltage range.</i>
	<b>CLASSE I</b> CLASS I	Apparecchio provvisto di collegamento di messa a terra di protezione.	<i>Luminaire with earth/ground connection.</i>
	<b>CLASSE II</b> CLASS II	Apparecchio che non richiede la connessione di messa a terra perché dotato di un doppio involucro di materiale isolante.	<i>Luminaire that does not require earth/ground connection because double insulated.</i>
	<b>CLASSE III</b> CLASS III	Apparecchio con tensioni non superiori alla bassissima tensione di sicurezza SELV (Safety Extra-Low Voltage). In pratica tale apparecchio viene alimentato o da una batteria o da un trasformatore SELV.	<i>Luminaire with voltages not exceeding the very low safety voltage SELV (Safety Extra-Low Voltage). In practice, this device is powered either by a battery or by a SELV transformer.</i>

	<b>VITA NOMINALE</b> NOMINAL LIFE	Indica la durata in ore a cui sopravvive il 50% delle lampade di un lotto campione. Per le lampade LED, si considera esaurita quando il flusso luminoso cala del 30% rispetto al valore iniziale.	Indicates the lifespan in hours at which 50% of the lamps in a sample batch survive. For LED lamps, they are considered expired when the luminous flux drops by 30% from the initial value.
	<b>ACCENSIONI ON/OFF</b> NUMBER OF ON/OFF CYCLES	Numero di accensioni per cui la lampada è collaudata.	Number of on/off cycles for which the lamp is tested.
	<b>TEMPERATURA DI FUNZIONAMENTO</b> OPERATING TEMPERATURE	Temperatura ambiente entro la quale l'apparecchio può lavorare correttamente.	Ambient temperature within which the luminaire operates correctly.
	<b>REGOLAZIONE CCT</b> CCT ADJUSTMENT	Possibilità di regolazione della temperatura di colore che definisce l'aspetto del colore di un LED bianco.	Possibility of adjusting the color temperature that defines the color appearance of a white LED.
	<b>POTENZA SELEZIONABILE</b> POWER SELECTABLE	Possibilità di regolazione della potenza dell'apparecchio tramite selettore.	Possibility to adjust the power of the device through a selector.
	 <b>UTILIZZO CON DIMMERS</b> DIMMER	Il simbolo indica se la lampada può essere o non può essere utilizzata con regolatori di luce.	The symbol indicates whether the lamp can or cannot be used with dimmers.
	<b>OUTDOOR</b>	Apparecchio adatto per esterni.	Luminaire for outdoor use.
	 <b>PIR / RADAR</b>	Apparecchio con sensore di rilevamento movimento: PIR: passivo ad infrarossi. RADAR: a microonde.	Luminaire with motion detection sensor: PIR: passive infrared. RADAR: microwave.
	<b>APPARECCHIO EMERGENZA</b> EMERGENCY FIXTURE	Apparecchio a funzione luce di emergenza.	Emergency light luminaire.
	 <b>APP DIMMABLE WIRELESS</b>	Nelle lampade smart, è possibile regolare la dimmerazione (intensità luminosa) tramite collegamento wireless, consentendo un controllo pratico e personalizzato dell'illuminazione.	In smart lamps, it is possible to adjust dimming (light intensity) via wireless connection, allowing for practical and customized lighting control.
	<b>INDICE RESA CROMATICA</b> COLOR RENDERING INDEX	L'indice di resa cromatica (CRI) è una scala da 0 a 100 che misura la capacità di una sorgente luminosa di riprodurre accuratamente i colori. Un CRI superiore a 90 è eccellente, mentre un valore tra 80 e 90 è considerato buono, garantendo colori abbastanza fedeli.	The Color Rendering Index (CRI) is a scale from 0 to 100 that measures a light source's ability to accurately reproduce colors. A CRI above 90 is excellent, while a value between 80 and 90 is considered good, ensuring fairly accurate colors.
	<b>INDICE UNIFICATO ABBAGLIAMENTO</b> UNIFIED GLARE RATING	UGR (Unified Glare Rating) è l'indice che misura l'abbagliamento luminoso molesto, regolato da normative europee e nazionali per gli ambienti lavorativi. Ad esempio: UGR 16 per laboratori di disegno e sale operatorie, UGR 19 per uffici e aule, UGR 28 per corridoi e ingressi.	UGR (Unified Glare Rating) measures disturbing light glare and is regulated by European and national standards for workplaces. For example: UGR 16 for drawing labs and operating rooms, UGR 19 for offices and classrooms, UGR 28 for corridors and entrances.
	<b>DOPPIO FUSIBILE</b> DOUBLE FUSE	Lampada con doppio fusibile all'interno del corpo.	Lamp with double fuse, internally mounted.
	<b>CONFEZIONE</b> PACKAGING	Confezione di tipo blister.	Blister pack.
	 <b>TECNOLOGIA LAMPADA</b> LAMP TECHNOLOGY	MH: a ioduri metallici / MHC: ioduri metallici e bruciatore ceramico / HPS: al sodio.	MH: metal iodide / MHC: metal iodide lamp with ceramic burner / HPS: sodium lamp.
			

Qualità del prodotto, tecnologia innovativa, durata e caratteristiche illuminotecniche risultano gli elementi vincenti delle lampade a LED di Bot Lighting, per questo motivo abbiamo deciso di offrire un vantaggio esclusivo al nostro cliente.

*Product quality, innovative technology, duration and lighting engineering features make the LED lamps by Bot Lighting a sure success, which is why we are offering our customers an exclusive advantage.*



Lampade con vita media nominale **< 25.000 ORE**

Lamps with nominal average lifetime **< 25,000 HOURS**



Lampade con vita media nominale **≥ 25.000 ORE** e minore di **40.000 ORE**

Lamps with nominal average lifetime **≥ 25,000 HOURS** and less than **40,000 HOURS**



Lampade con vita media nominale **≥ 40.000 ORE**

Lamps with nominal average lifetime **≥ 40,000 HOURS**

La presente garanzia copre esclusivamente i Prodotti impiegati alle seguenti condizioni di utilizzo che devono verificarsi contemporaneamente ai fini della copertura di garanzia:

- I prodotti devono essere installati correttamente ed utilizzati secondo le istruzioni.
- I prodotti devono funzionare in un range di tensione pari a 230 V +/- 10%.
- L'umidità nell'impianto non superi mai l'80%
- Il periodo di garanzia presuppone un utilizzo di funzionamento massimo di 4.000 ore all'anno ad una temperatura costante di 25 ° con 10 mm. minimo di spazio intorno alla lampada.
- Il periodo di garanzia decorre a partire dalla data di acquisto riportata sulla fattura/scontrino fiscale e/o dal lotto di produzione riportato su ciascun prodotto.
- Le sorgenti luminose a LED sono progettate per essere installate in apparecchi aperti e con sufficiente ventilazione. L'impiego in apparecchi chiusi ne può ridurre sensibilmente la durata ed invalida la garanzia.

Approfondimento termini e condizioni di garanzia  
[www.botlighting.it/warranty](http://www.botlighting.it/warranty)

*This warranty only covers Products used according to the conditions of use listed below, which must all be met for the purpose of warranty coverage.*

- *The products must be properly installed and used in accordance with the manufacturer's instructions.*
- *The products must operate in a voltage range of 230 V +/- 10%.*
- *The humidity in the system never exceeds 80%*
- *The warranty period assumes a maximum operating use of 4,000 hours per year at a constant temperature of 25 ° with 10 mm. minimum space around the lamp.*
- *The warranty period starts from the date of purchase shown on the invoice / receipt and / or from the production lot shown on each product.*
- *LED light sources are designed to be installed in open fixtures with sufficient ventilation. The use in closed appliances can significantly reduce the duration and invalidate the warranty*

More info  
[www.botlighting.it/warranty](http://www.botlighting.it/warranty)

1. Gli ordini sono subordinati all'accettazione del fornitore. Le offerte ed accettazioni di ordini si intendono ai prezzi ed alle condizioni di vendita in vigore al momento della spedizione della merce, salvo disponibilità. Gli ordini anche se raccolti tramite il nostro personale di vendita, sono vincolati all'accettazione da parte di BOT LIGHTING Srl, che può essere anche parziale.

2. Alla Venditrice non potrà essere addossata alcuna responsabilità per mancata accettazione, ovvero per mancata o ritardata fornitura dei prodotti oggetto dello stesso. L'accettazione e l'esecuzione dell'ordine sono specificatamente subordinate alla disponibilità dei prodotti ordinati nonché all'assenza di circostanze che possano comunque influire sulla reperibilità degli stessi e sulla loro tempestività di consegna. I termini di consegna sono indicativi e l'acquirente non può pretendere la rifusione di danni in caso di ritardi nelle consegne per cause non imputabili al fornitore. Gli eventuali ritardi nelle consegne, così come le interruzioni e/o sospensioni totali o parziali delle forniture, anche se non dovute a causa di forza maggiore e/o caso fortuito, non daranno diritto al risarcimento di danni e/o indennizzi di qualsiasi tipo, ivi inclusi quelli diretti, indiretti e consequenziali, nonché interessi.

3. La merce viaggia a rischio e pericolo dell'acquirente e in caso di furti, manomissioni, l'acquirente dovrà rivolgersi esclusivamente al vettore. In qualsiasi caso le anomalie riscontrate alla consegna dovranno essere notificate a BOT LIGHTING Srl con la seguente modalità:

- nel caso di colli sfusi verificare sempre all'atto della consegna il numero esatto dei colli e le eventuali rotture. Eventuali riserve precise dovranno sempre essere verbalizzate sul documento di trasporto e sull'eventuale bollettino del trasportatore.

- nel caso di bancali e quindi di impossibilità al controllo immediato alla consegna è necessario accettare la consegna stessa con "riserva di verifica" da essere segnalata nell'apposito riquadro del documento di trasporto e nell'eventuale bollettino del corriere.

I reclami dovranno pervenire a BOT LIGHTING Srl entro 3 giorni dal ricevimento del materiale.

4. Non appena ricevuti i prodotti, l'Acquirente sarà tenuto a verificare lo stato, la quantità della fornitura e la sua rispondenza alla bolla di consegna. Eventuali reclami in merito alla qualità, quantità, tipo del prodotto, dovranno essere fatti per iscritto entro 5 (cinque) giorni dalla data di ricevimento della merce. Decorso tale termine, fatte comunque salve le diverse condizioni di garanzia previste per i singoli prodotti, nessun reclamo potrà essere avanzato sia per la sostanza e la qualità della merce, sia per le condizioni in genere della stessa.

5. Eventuali difetti di fabbricazione dovranno essere tempestivamente denunciati e, dopo verifica di accertamento, saranno dal fornitore accreditati in toto od in parte, oppure sostituiti. Eventuali resi dovranno essere preventivamente concordati con il fornitore e si intendono "salvo verifica".

6. I prezzi di listino formulati si intendono per merce franca presso il deposito del fornitore; imballi speciali, assicurazione, resa e trasporto, imposte e tasse (IVA, ecc.) sono addebitabili a parte. Il prezzo indicato in tabella è da considerarsi come € prezzo suggerito al pubblico.

7. Nel commercio dei prodotti, oggetto del contratto, l'acquirente si asterrà da qualsiasi atto contrario ai principi della concorrenza leale, in conformità alle leggi, ai regolamenti nonché agli usi, in quanto compatibili.

8. Il pagamento della merce, nei termini ed alle condizioni di volta in volta stabiliti, dovrà essere effettuato presso il domicilio del fornitore, oppure ad un incaricato a ciò espressamente delegato. In quest'ultimo caso i pagamenti non si intendono effettuati finché le relative somme non pervengano alla sede centrale. Il mancato rispetto delle condizioni di pagamento stabilite o pagamenti differiti rispetto alle condizioni inizialmente concordate, determineranno l'applicazione degli interessi di mora, decorrenti dalla data di scadenza di pagamento della fattura e da determinarsi in base alla normativa di legge al momento vigente. In caso di controversia, per qualsiasi ragione, l'acquirente non ha alcun diritto di ritardare o di rifiutare il pagamento delle fatture scadute. Eventuali sconti cassa, nonché abbuoni o premi di qualsiasi natura saranno riconosciuti a condizione che il cliente non abbia pagamenti in sospeso e si intenderanno automaticamente decaduti e revocati in caso di mancato o ritardato pagamento. Ci riserviamo la facoltà di non dare esecuzione agli ordini di acquirenti che non abbiano provveduto al puntuale pagamento di forniture precedenti.

9. In caso di controversie si stabilisce la competenza esclusiva del Foro di Venezia.

10. La BOT LIGHTING Srl è impegnata a sviluppare e migliorare i propri prodotti. Per questa ragione tutte le descrizioni di questo catalogo-listino sono intese come guida generale e le specifiche possono essere cambiate di volta in volta nell'interesse del miglioramento del prodotto. Inoltre, eventuali modifiche sulle caratteristiche e sulla gamma di prodotti commercializzati che possono essere apportati dai produttori in qualsiasi momento senza preavviso, escludono la Bot Lighting Srl da alcuna responsabilità.

1. Orders are subject to acceptance by the supplier. Quotations and acceptances of orders are agreed as at the prices and on the terms and conditions of sale in force at the time of dispatching the goods, subject to availability. Even if orders have been taken through our sales staff, final acceptance, which may be partial, has to be made by BOT LIGHTING Srl.

2. The Seller shall not be held liable for non-acceptance or for failure or delay in supplying the products forming the subject matter of the supply. Acceptance and processing of the order are specifically subject to the availability of the ordered products as well as the absence of circumstances which could in any way affect the availability of the same and prompt delivery thereof. The delivery times are given as an indication and the buyer may not make any claim in the event of delays in deliveries due to causes not attributable to the supplier. Any delays in deliveries, as also total or partial stoppages or suspensions of supplies, even when not due to force majeure, do not entitle the customer to claim for damage or loss, whether direct, indirect or consequential, or indemnity of any type whatsoever, or interest.

3. The goods travel at the buyer's risk and in the event of theft or tampering, the buyer shall contact the carrier, whereas any faults or defects found at the time of delivery shall be reported to BOT LIGHTING Srl

as follows:

- in the case of loose packs, always check at the time of delivery the precise number of packs and check for any breakages. Any reservations shall always be written on the transport document and on any carrier's delivery note.

- in the case of pallets and therefore the impossibility of an immediate check of the goods, it is necessary to accept the delivery with "subject to checking" to be written in the relative box on the transport document and on any carrier's delivery note.

Complaints shall be sent to BOT LIGHTING Srl within 3 days of receiving the material.

4. The Buyer is obliged to check the state and quantity of the supply as well as its compliance with the delivery note as soon as the products have been received. Any complaints regarding quality, quantity and type of product shall be made in writing within 5 (five) days from the date of receiving the goods. After that period, without prejudice to other warranty conditions given for single products, no complaint may be made either for the substance and quality of the goods or for the general conditions of the same.

5. Any manufacturing defects shall be promptly reported and, after verification and assessment, the goods will either be replaced or the amount paid for the same credited in full or in part to the customer by the supplier. Any returns shall be previously agreed with the supplier and are agreed as "subject to verification".

6. The list prices given are agreed as for goods ex supplier's warehouse; special packaging, insurance, delivery and transportation, duties and taxes (VAT, etc.) are charged separately. The price indicated is to be considered the recommended retail price.

7. In selling the products forming the subject matter of the contract, the buyer will refrain from any act contrary to the principles of fair competition, in compliance with the law, regulations and accepted practice, insofar as they are compatible.

8. The goods shall be paid, within the times and on the conditions established case by case, c/o the domicile of the supplier or to an expressly designated person. In the latter case the payments are not considered as made until the relative sums are received at head office. Failure to comply with the established conditions of payment or deferred payments in respect of the initially agreed conditions will result in the application of default interest as from the due date of payment of the invoice, to be determined according to the provisions of law in force at the time. In the event of a dispute, for any reason whatsoever, the buyer is not entitled to delay or to refuse payment of the overdue invoices. Any cash discounts as well as allowances or bonuses of any kind will be acknowledged provided that the customer has no outstanding payments, but will be agreed as automatically forfeited and revoked in the event of late or non-payment. We reserve the right not to carry out the orders of buyers who have not arranged for punctual payment of previous supplies.

9. In the event of disputes, it is established that the Court of Venice shall have sole jurisdiction.

10. BOT LIGHTING Srl is committed to developing and improving its products. All the descriptions in this catalogue-price list are therefore agreed as being a general guide and the specifications may be changed from time to time in the interests of product improvement. Furthermore, Bot Lighting Srl cannot be held liable for any changes to the characteristics and the range of outsourced products, which may be introduced by the manufacturers at any time without notice.

#### NOTE:

Alcune immagini ambientate presenti in questo catalogo sono state realizzate o ottimizzate con il supporto dell'intelligenza artificiale per finalità illustrative.

Colori, finiture, proporzioni e dettagli ambientali possono presentare lievi differenze rispetto alla resa reale del prodotto. Fanno fede le specifiche tecniche e le eventuali immagini fotografiche ufficiali.

#### NOTE:

Some lifestyle images featured in this catalog have been created or enhanced with the support of artificial intelligence for illustrative purposes.

Colors, finishes, proportions, and environmental details may show slight differences compared to the actual product. Official technical specifications and any photographic images shall prevail.

<b>CODICE</b>	<b>DESCRIZIONE</b>	<b>PAG</b>	<b>CODICE</b>	<b>DESCRIZIONE</b>	<b>PAG</b>
4107269	ALPPILA1S IP44 GU10 Max 35W ACCIAIO FISSO	360	9000-3/B-ST	BINARIO A 6 CONDUTTORI EUROSTANDARD ADVANCED NERO(RAL 9005) METRI 3	204
4107271	ALPPILA 2S IP44 2 x GU10 Max 35W ACCIAIO ATTACCO CENTRALE	361	9000-3/W-ST	BINARIO A 6 CONDUTTORI EUROSTANDARD ADVANCED BIANCO (RAL 9010) METRI 3	204
4107274	KALLIO B IP44 1 x E27 Max 60W GRIGIO	390	9000-KIT1-1.5	KIT COMPLETO PER FISSAGGIO A SOSPENSIONE BINARIO - 1,5 M	207
4107297	ARVIKA IP44 1 x E27 Max 60W BIANCO	369	9000-KIT1-3	KIT COMPLETO PER FISSAGGIO A SOSPENSIONE BINARIO - 3 M	207
4107298	ARVIKA IP44 1 x E27 Max 60W NERO	369	9000-KIT1-5	KIT COMPLETO PER FISSAGGIO A SOSPENSIONE BINARIO - 5 M	207
4116122	KALLIO B IP44 1 x E27 Max 60W ANTRACITE	390	9001/B	TESTATA DI ALIMENTAZIONE POLARITÀ DESTRA NERO	205
4116137	Plafoniera Rio LED 12W IP44 3000K	142	9001/W	TESTATA DI ALIMENTAZIONE POLARITÀ DESTRA BIANCO	205
4116164	Plafoniera Rio LED 20W 3000K IP44	142	9002/B	TESTATA DI ALIMENTAZIONE POLARITÀ SINISTRA NERO	206
4116165	Plafoniera Rio LED 12W 3000K IP44 RADAR con sensore di movimento	143	9002/W	TESTATA DI ALIMENTAZIONE POLARITÀ SINISTRA BIANCO	206
4116170	Plafoniera Rio LED 12W IP44 4000K	142	9003/B	GIUNTO PASSANTE PER BINARIO NERO	206
4118740	SUND IP44 GU10 Max 11W White	352	9003/W	GIUNTO PASSANTE PER BINARIO BIANCO	206
4118742	SUND DUO IP44 2 x GU10 Max 11W Bianco	353	9004/B	TAPPO DI CHIUSURA PER BINARIO CON VITE DI BLOCCO NERO	204
4118745	SUND IP44 GU10 Max 11W Antracite	352	9004/W	TAPPO DI CHIUSURA PER BINARIO CON VITE DI BLOCCO BIANCO	204
4118746	SUND DUO IP44 2 x GU10 Max 11W Antracite	353	9010/B	GIUNTO DIRETTO CON ALIMENTAZIONE DAL CENTRO NERO	207
4118754	SANSA PENDANT 1 x E27 Max 40W BIANCO/ARGENTO	289	9010/W	GIUNTO DIRETTO CON ALIMENTAZIONE DAL CENTRO BIANCO	207
4126225	SANSA PENDANT 1 x E27 Max 40W NERO/ARGENTO	289	9011/B	GIUNTO A L POLARITÀ INTERNA NERO	205
4146957	Plafoniera SONO III PIR LED 15W 3500K IP54 con sensore di movimento IR	150	9011/W	GIUNTO A L POLARITÀ INTERNA BIANCO	205
4508465	ALPPILA XL IP44 2 x GU10 Max 35W ATTACCO CENTRALE BIANCO	362	9012/B	GIUNTO A L POLARITÀ ESTERNA NERO	205
4508466	ALPPILA XL IP44 2 x GU10 Max 35W ATTACCO CENTRALE ANTRACITE	362	9012/W	GIUNTO A L POLARITÀ ESTERNA BIANCO	205
4711394	Goccia 470lm 5,5W E27 per cella frigorifera	115	A60WT60TW-S	A60 WiFi Tuya 806lm 6,5W E27 Stick CCT DIM	37
4711395	Goccia 840lm 8,5W E27 per cella frigorifera	115	A60WT75RTW	A60 WiFi+BLE Tuya 1055lm 10,0W E27 RGB+CCT DIM	38
4711503	Goccia 810lm 8,0W E27 828 per cella frigorifera	115	AITONA7Q	Segnapasso da esterno quadrato IP67 - GU10 7W MAX	432
4711504	Goccia 1055lm 10,5W E27 840 per cella frigorifera	115	AITONA7R	Segnapasso carrabile da esterno rotondo IP67 - GU10 7W MAX	433
4711528	Goccia 470lm 4,5W E27 827 per Sauna +60 °C	115	AITONA7R1	Segnapasso carrabile da esterno rotondo IP67 - Fascio singolo - GU10 7W MAX	433
4711773	PAR30 PLANT 800lm 9,5W E27 835 per crescita piante	116	AITONA7R2	Segnapasso carrabile da esterno rotondo IP67 - Fascio doppio - GU10 7W MAX	433
4713401	PAR20 PLANT 420lm 6,2W E14 835 per crescita piante	116	AITONA7R4	Segnapasso carrabile da esterno rotondo IP67 - Fascio quadruplo - GU10 7W MAX	433
8710464	Lampada da armadio con sensore di movimento 4 x AA	507	AKRONII20NLV	Proiettore LED 20W - 4000K - 12/24V AC-DC - Nero	282
8710478	WORKLIGHT Lampada da lavoro magnetica orientabile 3 x LR6/AA	503	AKRONII30NLV	Proiettore LED 30W - 4000K - 12/24V AC-DC - Nero	282
8710490	Torcia LED colori vari x 12pz 3xAAA	502	AL9TUV	AL 9W Germicida G23	128
8710503	CLIPPY Safety Light LED 2 x CR2032	502	ALICANTE10B	Applique LED IP54 Rettangolare 2x5W CCT Switch Bianco	322
9610413	CARA Desk Lamp 320lm 4,5W WW	302	ALICANTE10G	Applique LED IP54 Rettangolare 2x5W CCT Switch Antracite	322
9610414	CARA Clip Light 320lm 4,5W WW	300	ALL36TUV	ALL 36W 2G11 UVC	128
9610415	CARA Wall Lamp 320lm 4,5W WW	301	ALMERIAB	Plafoniera IP65 a cubetto GU10 Max 7W Bianco	343
9610559	URBAN PENDANT 1 x E27 Max 20W BIANCO	290	ALMERIAC	Plafoniera IP65 a cubetto GU10 Max 35W Corten	343
9610560	URBAN PENDANT 1 x E27 Max 20W NERO	290	ALMERIAG	Plafoniera IP65 a cubetto GU10 Max 35W Antracite	343
9610563	URBAN DESK S 1 x E27 Max 20W BIANCO	294	ALMERIAM	Plafoniera IP65 a cubetto GU10 Max 35W Grigio Marina	343
9610564	URBAN DESK S 1 x E27 Max 20W NERO	294	ALMERIAN	Plafoniera IP65 a cubetto GU10 Max 7W Nero	343
9610567	URBAN DESK L 1 x E27 Max 20W BIANCO	297	ARONA200	Segnapasso a LED per scatola fonda IP20 1,5W CCT	424
9610568	URBAN DESK L 1 x E27 Max 20W NERO	297	ARONA200FOA	Frontalino per segnapasso ARONA200 - Ovale - Grigio siderale	424
9610571	URBAN FLOOR 1 x E27 Max 20W BIANCO	298	ARONA200FOB	Frontalino per segnapasso ARONA200 - Ovale - Bianco	424
9610572	URBAN FLOOR 1 x E27 Max 20W NERO	298	ARONA200FOG	Frontalino per segnapasso ARONA200 - Ovale - Grigio chiaro	424
9783080	LOFT35 PENDANT 1 x E27 Max 60W BIANCO	286	ARONA200FON	Frontalino per segnapasso ARONA200 - Ovale - Nero	424
9783081	LOFT35 PENDANT 1 x E27 Max 60W NERO	286	ARONA200FRA	Frontalino per segnapasso ARONA200 - Rettangolare - Grigio siderale	424
6LR61	Transistor 9V Evolution (BL 1pz)	504	ARONA200FRB	Frontalino per segnapasso ARONA200 - Rettangolare - Bianco	424
6LR61/2	Transistor 9V Evolution (BL 2pz)	504	ARONA200FRG	Frontalino per segnapasso ARONA200 - Rettangolare - Grigio chiaro	424
9000-1/B-ST	BINARIO A 6 CONDUTTORI EUROSTANDARD ADVANCED NERO (RAL 9005) METRI 1	204	ARONA200FRN	Frontalino per segnapasso ARONA200 - Rettangolare - Nero	424
9000-1/W-ST	BINARIO A 6 CONDUTTORI EUROSTANDARD ADVANCED BIANCO (RAL 9010) METRI 1	204			
9000-2/B-ST	BINARIO A 6 CONDUTTORI EUROSTANDARD ADVANCED NERO (RAL 9005) METRI 2	204			
9000-2/W-ST	BINARIO A 6 CONDUTTORI EUROSTANDARD ADVANCED BIANCO (RAL 9010) METRI 2	204			

CODICE	DESCRIZIONE	PAG	CODICE	DESCRIZIONE	PAG
ARONA300	Segnapasso a LED per scatola 503 IP20 1,5W CCT	425	B111037033Z	Batteria Li-ION 18650 1 cella 3,7V 3300mAh per YUMA10NK (necessari 2 pezzi)	447
ARONA300FOA	Frontalino per segnapasso ARONA300 - Ovale - Grigio siderale	425	B112037036A	Batteria Li-ION 18650 2 celle 3,7V 3600mAh per YU-MA1500NK	448
ARONA300FOB	Frontalino per segnapasso ARONA300 - Ovale - Bianco	425	B112037040A	Batteria Li-ION 18650 2 celle 3,7V 4000mAh per INCLINE8N	462
ARONA300FOG	Frontalino per segnapasso ARONA300 - Ovale - Grigio chiaro	425	B112037044A	Batteria Li-ION 18650 2 celle 3,7V 4400mAh per WORK10SUN	492
ARONA300FON	Frontalino per segnapasso ARONA300 - Ovale - Nero	425	B113037060A	Batteria Li-ION 18650 3 celle 3,7V 6000mAh per GLOWA	470
ARONA300FRA	Frontalino per segnapasso ARONA300 - Rettangolare - Grigio siderale	425	B114037088A	Batteria Li-ION 18650 4 celle 3,7V 8800mAh per WORK20E	493
ARONA300FRB	Frontalino per segnapasso ARONA300 - Rettangolare - Bianco	425	B114074036A	Batteria Li-ION 18650 4 celle 7,4V 3600mAh per YU-MA2800NK	449
ARONA300FRG	Frontalino per segnapasso ARONA300 - Rettangolare - Grigio chiaro	425	B221032060A	Batteria LiFePO4 32700 1 cella 3,2V 6000mAh per YUMA11NK	452
ARONA300FRN	Frontalino per segnapasso ARONA300 - Rettangolare - Nero	425	B222032070A	Batteria LiFePO4 32700 2 celle 3,2V 7000mAh per YUMA350P	472
ARONA301	Segnapasso a LED per scatola 503 IP66 4,5W CCT Bianco	420	B222064060A	Batteria LiFePO4 32700 2 celle 6,4V 6000mAh per KA-LAP4800NK, KALAP48HY e YUMA4800NK	438
ARONA302	Segnapasso a LED per scatola 503 IP66 4,5W CCT Bianco	420	B222064060A	Batteria LiFePO4 32700 2 celle 6,4V 6000mAh per KA-LAP4800NK, KALAP48HY e YUMA4800NK	440
ARONA303	Segnapasso a LED per scatola 503 IP65 2,5W CCT	418	B222064060A	Batteria LiFePO4 32700 2 celle 6,4V 6000mAh per KA-LAP4800NK, KALAP48HY e YUMA4800NK	450
ARONA303EM	Segnapasso a LED per scatola 503 IP20 3,0W CCT Emergenza	418	B222064060B	Batteria LiFePO4 32700 2 celle 6,4V 6000mAh per YUMA15NK e YUMA20NK	454
ARONA304	Segnapasso a LED per scatola 503 IP65 2,5W CCT Asimmetrico	418	B226096012A	Batteria LiFePO4 32700 6 celle 9,6V 12000mAh per YU-MA40NK e YUMA63HY	456
ARONA601	Segnapasso a LED per scatola 506 IP65 4,5W CCT	419	B234032080A	Batteria LiFePO4 18730 4 celle 3,2V 8000mAh per YU-MA1200P	474
ARONA601EM	Segnapasso a LED per scatola 506 IP65 3,5W CCT Emergenza	419	BARRELE27B	Applique IP44 E27 Bianca	366
ARONA602	Segnapasso a LED per scatola 506 IP65 6W CCT	421	BARRELE27G	Applique IP44 E27 Antracite	366
ARONA603	Segnapasso a LED asimmetrico per scatola 506 IP65 6W CCT	421	BERNAB	Pendant cilindrico da binario GU10 Bianco	194
ARONAB	Scatola tonda per per segnapasso ARONA200	424	BERNAN	Pendant cilindrico da binario GU10 Nero	194
ATLANTA30NK	Proiettore LED 30W - 3CCT - Nero	280	BIKIT	KIT LUCI DA BICI	500
ATLANTA50NK	Proiettore LED 50W - 3CCT - Nero	280	BILBAO3BQ	Segnapasso a LED Quadrato IP65 3W CCT Bianco	428
ATLANTAPIRB	Sensore PIR-B per ATLANTA	280	BILBAO3CQ	Segnapasso a LED Quadrato IP65 3W CCT Corten	428
AVENUEB	Applique Solare ricaricabile LED Bianca 5,2W- 4000K-1000lm-IP54 - Batteria Litio 2000mAh	478	BILBAO3GQ	Segnapasso a LED Quadrato IP65 3W CCT Antracite	428
AVENUEB2	Applique Solare ricaricabile LED Bianca 5,2W- 3000K-1000lm-IP54 - Batteria Litio 2000mAh	478	BILBAO3MQ	Segnapasso a LED Quadrato IP65 3W CCT Grigio Marina	428
AVENUEC	Applique Solare ricaricabile LED Corten 5,2W- 4000K-1000lm-IP54 - Batteria Litio 2000mAh	478	BILBAO6BQ	Segnapasso a LED Quadrato IP65 6,5W CCT Bianco	429
AVENUEC2	Applique Solare ricaricabile LED Corten 5,2W- 3000K-1000lm-IP54 - Batteria Litio 2000mAh	478	BILBAO6CQ	Segnapasso a LED Quadrato IP65 6,5W CCT Corten	429
AVENUEN	Applique Solare ricaricabile LED Nera 5,2W- 4000K-1000lm-IP54 - Batteria Litio 2000mAh	478	BILBAO6GQ	Segnapasso a LED Quadrato IP65 6,5W CCT Antracite	429
AVENUEN2	Applique Solare ricaricabile LED Nera 5,2W- 3000K-1000lm-IP54 - Batteria Litio 2000mAh	478	BILBAO6MQ	Segnapasso a LED Quadrato IP65 6,5W CCT Grigio Marina	429
AVILABS	Applique IP44 1 x GU10 Max 7W Bianco con sensore crepuscolare	358	BODO16	DL6,0-16W Faro incasso LED 16W- 1700lm con cambio CCT - Bianco	184
AVILACS	Applique IP44 1 x GU10 Max 7W Corten con sensore crepuscolare	358	BODO20	DL7,0-20W Faro incasso LED 20W- 2150lm con cambio CCT - Bianco	184
AVILAGS	Applique IP44 1 x GU10 Max 7W Antracite con sensore crepuscolare	358	BODO2020	DL30-20W Faro incasso LED 20W- 1530lm 3000K orientabile - Bianco	186
B111037012B	Batteria Li-ION 18650 1 cella 3,7V 1200mAh per INCLINE2N ARONA303EM	460	BODO2030	DL30-20W Faro incasso LED 20W- 1530lm 4000K orientabile - Bianco	186
B111037020A	Batteria Li-ION 18650 1 cella 3,7V 2000mAh per CLAY MOON YUCCA YUCCAP	476	BODO24	DL8,0-24W Faro incasso LED 24W- 2650lm con cambio CCT - Bianco	184
B111037020A	Batteria Li-ION 18650 1 cella 3,7V 2000mAh per CLAY MOON YUCCA YUCCAP	480	BODO4	DL3,0-4W Faro incasso LED 4W- 380lm con cambio CCT - Bianco	184
B111037020A	Batteria Li-ION 18650 1 cella 3,7V 2000mAh per CLAY MOON YUCCA YUCCAP	482	BODO620	DL3,0-6W Faro incasso LED 6W- 425lm 3000K orientabile - Bianco	186
B111037020A	Batteria Li-ION 18650 1 cella 3,7V 2000mAh per CLAY MOON YUCCA YUCCAP	484	BODO630	DL3,0-6W Faro incasso LED 6W- 425lm 4000K orientabile - Bianco	186
B111037020B	Batteria Li-ION 18650 1 cella 3,7V 2000mAh per INCLINE4N	461	BODO8	DL4,0-8W Faro incasso LED 8W- 780lm con cambio CCT - Bianco	184
B111037024Z	Batteria Li-ION 18650 1 cella 3,7V 2400mAh per YUMA8NP (necessari 2 pezzi)	465	BODOI124KD	DL8,0-24W Faro incasso LED 24W- 2800lm 3CCT Dimmerabile - Bianco	185
B111037026A	Batteria Li-ION 18650 1 cella 3,7V 2600mAh per MARBELLA-9SUN e MARBELLA10SUN	466	BODOI1EM3	BODO II - KIT EM 3h	185
B111037026A	Batteria Li-ION 18650 1 cella 3,7V 2600mAh per MARBELLA-9SUN e MARBELLA10SUN	468	BURGOS12BK	Plafoniera LED 12W Triangolare 3 CCT Bianca IP65	160
B111037030Z	Batteria Li-ION 18650 1 cella 3,7V 3000mAh per YUMA6NK	446	BURGOS12NK	Plafoniera LED 12W Triangolare 3 CCT Nera IP65	160
			C2IP68DC	Connettore stagno IP68 a tre vie a due poli	409
			C37WT40RTW	C37 WiFi Tuya 470lm 5,0W E14 RGB+CCT DIM	38
			CABLETL	Cavo di ricarica USB-A - USB-C 1m	312
			CABLETL	Cavo di ricarica USB-A - USB-C 1m	316

CODICE	DESCRIZIONE	PAG	CODICE	DESCRIZIONE	PAG
CABLETL	Cavo di ricarica USB-A - USB-C 1m	318	ELD2003X2	Oliva 250lm 2,7W E14 OP WW	86
CADICEE27C	Applique IP44 E27 Corten	388	ELD2003X3	Oliva 250lm 2,7W E14 OP CW	86
CADICEE27CP	Paletto da giardino IP44 E27 Corten 80cm	389	ELD2006X1	Oliva 470lm 4,9W E14 OP DL	86
CADICEE27G	Applique IP44 E27 Antracite	388	ELD2006X2	Oliva 470lm 4,9W E14 OP WW	86
CADICEE27GP	Paletto da giardino IP44 E27 Antracite 80cm	389	ELD2006X2BB	Oliva 470lm 4,9W E14 OP WW	86
CLAYN	Applique Solare ricaricabile LED Nera 5,2W- 4000K-1000lm IP65 - Batteria Litio 2000mAh	476	ELD2006X3	Oliva 470lm 4,9W E14 OP CW	86
CLAYN2	Applique Solare ricaricabile LED Nera 5,2W- 3000K-1000lm IP65 - Batteria Litio 2000mAh	476	ELD2010X1	Oliva 806lm 6,5W E14 OP DL	86
COCO162	COCO 310mm 14,0W 220/240V WarmWhite	140	ELD2010X2	Oliva 806lm 6,5W E14 OP WW	86
COCO163	COCO 310mm 14,0W 220/240V CoolWhite	140	ELD2010X2BB	Oliva 806lm 6,5W E14 OP WW	86
COCO212	COCO 360mm 21,0W 220/240V WarmWhite	140	ELD2010X3	Oliva 806lm 6,5W E14 OP CW	86
COCO213	COCO 360mm 17,0W 220/240V CoolWhite	140	ELD2011X1	Oliva 1055lm 6,5W E14 OP DL	86
COCO242	COCO 410mm 24,0W 220/240V WarmWhite	140	ELD2011X2	Oliva 1055lm 6,5W E14 OP WW	86
COCO243	COCO 410mm 24,0W 220/240V CoolWhite	140	ELD2011X2BB	Oliva 1055lm 6,5W E14 OP WW	86
CORDOVA10BK	Applique LED IP65 2x5W Bianco CCT	356	ELD2011X3	Oliva 1055lm 6,5W E14 OP CW	86
CORDOVA10CK	Applique LED IP65 2x5W Corten CCT	356	ELD3003X1	Sfera 250lm 2,7W E14 OP DL	85
CORDOVA10GK	Applique LED IP65 2x5W Antracite CCT	356	ELD3003X2	Sfera 250lm 2,7W E14 OP WW	85
CORDOVA1B	Applique IP65 GU10 Max 35W Bianco	354	ELD3003X3	Sfera 250lm 2,7W E14 OP CW	85
CORDOVA1C	Applique IP65 GU10 Max 35W Corten	354	ELD3006X1	Sfera 470lm 4,9W E14 OP DL	85
CORDOVA1G	Applique IP65 GU10 Max 35W Antracite	354	ELD3006X2	Sfera 470lm 4,9W E14 OP WW	85
CORDOVA1M	Applique IP65 GU10 Max 35W Grigio Marina	354	ELD3006X2BB	Sfera 470lm 4,9W E14 OP WW	85
CORDOVA2B	Applique IP65 2 x GU10 Max 35W Bianco	355	ELD3006X3	Sfera 470lm 4,9W E14 OP CW	85
CORDOVA2C	Applique IP65 2 x GU10 Max 35W Corten	355	ELD3010X1	Sfera 806lm 7,2W E14 OP DL	85
CORDOVA2G	Applique IP65 2 x GU10 Max 7W Antracite	355	ELD3010X2	Sfera 806lm 7,2W E14 OP WW	85
CORDOVA2M	Applique IP65 2 x GU10 Max 35W Grigio Marina	355	ELD3010X2BB	Sfera 806lm 7,2W E14 OP WW	85
D95WT100RTW	D95 WiFi+BLE Tuya 1521lm 12,0W E27 RGB+CCT DIM	39	ELD3010X3	Sfera 806lm 7,2W E14 OP CW	85
DL-D/PMINI12-48	Regolatore di luminosità per driver LED in tensione costante 12-48Vdc DALI - PUSH - 1-10V	221	ELD3011X1	Sfera 1055lm 6,5W E14 OP DL	85
DRV243567	LED Driver 24V 35Wmax IP67	220	ELD3011X2	Sfera 1055lm 6,5W E14 OP WW	85
ELD1007X1	Goccia 470lm 4,9W E27 OP DL	82	ELD3011X2BB	Sfera 1055lm 6,5W E14 OP WW	85
ELD1007X2	Goccia 470lm 4,9W E27 OP WW	82	ELD3011X3	Sfera 1055lm 6,5W E14 OP CW	85
ELD1008X3AM	Goccia 806lm 8,0W E27 CW-Mosquito	115	ELD3103X1	Sfera 250lm 3,0W E27 OP DL	84
ELD1009X1	Goccia 806lm 8,5W E27 OP DL	82	ELD3103X2	Sfera 250lm 2,7W E27 OP WW	84
ELD1009X2	Goccia 806lm 8,5W E27 OP WW	82	ELD3103X3	Sfera 250lm 2,7W E27 OP CW	84
ELD1009X2BB	Goccia 806lm 8,5W E27 OP WW	82	ELD3106X1	Sfera 470lm 4,9W E27 OP DL	84
ELD1009X3	Goccia 806lm 8,5W E27 OP CW	82	ELD3106X2	Sfera 470lm 4,9W E27 OP WW	84
ELD1012X1	Goccia 1055lm 9,5W E27 OP DL	82	ELD3106X2BB	Sfera 470lm 4,9W E27 OP WW	84
ELD1012X2	Goccia 1055lm 9,5W E27 OP WW	82	ELD3106X3	Sfera 470lm 4,9W E27 OP CW	84
ELD1012X2BB	Goccia 1055lm 9,5W E27 OP WW	82	ELD3110X1	Sfera 806lm 7,2W E27 OP DL	84
ELD1012X3	Goccia 1055lm 9,5W E27 OP CW	82	ELD3110X2	Sfera 806lm 7,2W E27 OP WW	84
ELD1015X1	Goccia 1521lm 13,0W E27 OP DL	82	ELD3110X2BB	Sfera 806lm 7,2W E27 OP WW	84
ELD1015X2	Goccia 1521lm 13,0W E27 OP WW	82	ELD3110X3	Sfera 806lm 7,2W E27 OP CW	84
ELD1015X2BB	Goccia 1521lm 13,0W E27 OP WW	82	ELD3111X1	Sfera 1055lm 6,5W E27 OP DL	84
ELD1015X3	Goccia 1521lm 13,0W E27 OP CW	82	ELD3111X2	Sfera 1055lm 6,5W E27 OP WW	84
ELD1016X1B	Goccia 1901lm 14,0W E27 OP DL	82	ELD3111X2BB	Sfera 1055lm 6,5W E27 OP WW	84
ELD1016X2B	Goccia 1901lm 14,0W E27 OP WW	82	ELD3111X3	Sfera 1055lm 6,5W E27 OP CW	84
ELD1016X2BB	Goccia 1901lm 14,0W E27 OP WW	82	ELD770752	GX53 6,5W 830 WW	109
ELD1016X3B	Goccia 1901lm 14,0W E27 OP CW	82	ELD770753	GX53 6,5W 840 CW	109
ELD1020X1	Goccia A67 2452lm 17,5W E27 OP DL	83	ELD770852	GX53 8,0W 830 WW	109
ELD1020X2	Goccia A67 2452lm 17,5W E27 OP WW	83	ELD770853	GX53 8,0W 840 CW	109
ELD1020X3	Goccia A67 2452lm 17,5W E27 OP CW	83	EMK3-60-49-A	KIT Emergenza 3,0W 4900mAh -3h	176
ELD1025X1	Goccia A80 3452lm 23,5W E27 OP DL	83	EMMA-A	Lampada da tavolo ricaricabile Carta da Zucchero 3W 250LM dim 3000K IP54 2x2200mAh	308
ELD1025X2	Goccia A80 3400lm 23,5W E27 OP WW	83	EMMA-B	Lampada da tavolo ricaricabile Bianca 3W 250LM dim 3000K IP54 2x2200mAh	308
ELD1025X3	Goccia A80 3400lm 23,5W E27 OP CW	83	EMMA-C	Lampada da tavolo ricaricabile Corten 3W 250LM dim 3000K IP54 2x2200mAh	308
ELD2003X1	Oliva 250lm 2,7W E14 OP DL	86	EMMACB	Base di ricarica per lampada da tavolo ricaricabile EMMA	308

CODICE	DESCRIZIONE	PAG	CODICE	DESCRIZIONE	PAG
EMMACB12	Base di ricarica multipla 12 posti per lampada da tavolo ricaricabile EMMA ed EMMA MINI	308	GRANADA22C	Applique IP65 2 x GU10 Max 7W Corten	365
EMMACB12	Base di ricarica multipla 12 posti per lampada da tavolo ricaricabile EMMA ed EMMA MINI	310	GRANADA22G	Applique IP65 2 x GU10 Max 7W Antracite	365
EMMA-I	Lampada da tavolo ricaricabile Avorio 3W 250LM dim 3000K IP54 2x2200mAh	308	GRANADA2B	Applique IP54 2 x GU10 Max 25W Bianco	363
EMMAMINI-A	Mini Lampada da tavolo ricaricabile Carta da Zucchero 1,5W 130LM dim 3000K IP54 2200mAh	310	GRANADA2G	Applique IP54 2 x GU10 Max 25W Antracite	363
EMMAMINI-B	Mini Lampada da tavolo ricaricabile Bianca 1,5W 130LM dim 3000K IP54 2200mAh	310	GRANADA2M	Applique IP54 2 x GU10 Max 25W Grigio Marina	363
EMMAMINI-C	Mini Lampada da tavolo ricaricabile Corten 1,5W 130LM dim 3000K IP54 2200mAh	310	GRAZB	Proiettore da binario GU10 Bianco	196
EMMAMINICB	Base di ricarica per lampada da tavolo ricaricabile EMMA MINI	310	GRAZN	Proiettore da binario GU10 Nero	196
EMMAMINI-H	Mini Lampada da tavolo ricaricabile Avorio 1,5W 130LM dim 3000K IP54 2200mAh	310	GROV8B	Faro incasso LED 8W - 1000lm - CCT - Bianco - IP65 Front - UGR<19	189
EMMAMINI-N	Mini Lampada da tavolo ricaricabile Nero 1,5W 130LM dim 3000K IP54 2200mAh	310	GROV8N	Faro incasso LED 8W - 1000lm - CCT - Nero - IP65 Front - UGR<19	189
EMMAMINI-P	Mini Lampada da tavolo ricaricabile Blu Petrolio 1,5W 130LM dim 3000K IP54 2200mAh	310	GU10WT35RTW	GU10 WIFI Tuya 350lm 5,0W RGB+CCT DIM	39
EMMAMINI-R	Mini Lampada da tavolo ricaricabile Rosso Lampone 1,5W 130LM dim 3000K IP54 2200mAh	310	HEAD	Lampada da testa con inclinazione regolabile	500
EMMAMINI-V	Mini Lampada da tavolo ricaricabile Verde Salvia 1,5W 130LM dim 3000K IP54 2200mAh	310	HEAD-W	Lampada headlight con inclinazione regolabile	501
EMMA-N	Lampada da tavolo ricaricabile Nera 3W 250LM dim 3000K IP54 2x2200mAh	308	HUBTL50	HUB di ricarica USB per lampade da tavolo - 10 porte -50W	308
EMMA-P	Lampada da tavolo ricaricabile Blu Petrolio 3W 250LM dim 3000K IP54 2x2200mAh	308	HUBTL50	HUB di ricarica USB per lampade da tavolo - 10 porte -50W	310
EMMA-R	Lampada da tavolo ricaricabile Rosso Lampone 3W 250LM dim 3000K IP54 2x2200mAh	308	HUBTL50	HUB di ricarica USB per lampade da tavolo - 10 porte -50W	312
EMMA-V	Lampada da tavolo ricaricabile Verde Salvia 3W 250LM dim 3000K IP54 2x2200mAh	308	HUBTL50	HUB di ricarica USB per lampade da tavolo - 10 porte -50W	314
ERIKA24Q	CL2Q Plafoniera LED 24W Quadrata - CCT - Bianco IP54	145	HUBTL50	HUB di ricarica USB per lampade da tavolo - 10 porte -50W	316
ERIKA24R	CL2R Plafoniera LED 24W Circolare - CCT - Bianco IP54	144	HUBTL50	HUB di ricarica USB per lampade da tavolo - 10 porte -50W	318
EVA18K	Plafoniera flat 600mm 18,0W CCT3	238	IBIZA10C	Paletto da giardino IP65 GU10 Corten 100cm	392
EVA36K	Plafoniera flat 1200mm 36,0W CCT3	238	IBIZA10G	Paletto da giardino IP65 GU10 Antracite 100cm	392
EVA45K	Plafoniera flat 1500mm 45,0W CCT3	238	IBIZA5C	Paletto da giardino IP65 GU10 Corten 50cm	392
FLAME2N	Torcia fiamma Solare ricaricabile LED, 2W- 1500K IP65 - Batteria Litio	486	IBIZA5G	Paletto da giardino IP65 GU10 Antracite 50cm	392
FLASH1	TORCIA LED 500lm	501	INCLINE2N	Proiettore Solare ricaricabile LED 2W- 4000K-300lm IP65 - Batteria Litio	460
FLASH2	TORCIA LED 1500lm	501	INCLINE4N	Proiettore Solare ricaricabile LED 4W- 4000K-600lm IP65 - Batteria Litio	461
FROG	Proiettore multiuso ricaricabile 4W 530Lumen 3600mAh	494	INCLINE8N	Proiettore Solare ricaricabile LED 8W- 4000K-1200lm IP65 - Batteria Litio	462
GALA6B	Faro incasso LED 6W- 600lm - CCT - Bianco - UGR<16	188	IRIS12R	CL1R Plafoniera LED 12W Circolare - CCT - Bianco	132
GARDA	GARDA Table lamp 53cm Lampada da tavolo per esterni IP44 - E27	412	IRIS18R	CL1R Plafoniera LED 18W Circolare - CCT - Bianco	132
GARDAL	GARDA Floor lamp 154 cm Lampada da terra per esterni IP44 - E27	414	IRIS24Q	CL1R Plafoniera LED 24W Quadrata - CCT - Bianco	133
GIADAI12K	GIADA II 280mm 8/10/12W CCT	152	IRIS24R	CL1R Plafoniera LED 24W Circolare - CCT - Bianco	132
GIADAI12KE	GIADA II 280mm 8/10/12W CCT + EMERGENZA	152	J12079ES	Alo J 120W 79mm R7s	124
GIADAI12KS	GIADA II 280mm 8/10/12W CCT + SENSOR	152	J120ES	Alo J 120W 119mm R7s	124
GIADAI12KSE	GIADA II 280mm 8/10/12W CCT + SENS + EM	152	J8079ES	Alo J 80W 79mm R7s	124
GIADAI120K	GIADA II 320mm 12/16/20W CCT	152	J80ES	Alo J 80W 119mm R7s	124
GIADAI120KE	GIADA II 320mm 12/16/20W CCT + EMERGENZA	152	JEREZ2E27B	Applique IP44 E27 Bianca	368
GIADAI120KS	GIADA II 320mm 12/16/20W CCT + SENSOR	152	JEREZ2E27C	Applique IP44 E27 Corten	368
GIADAI120KSE	GIADA II 320mm 12/16/20W CCT + SENS + EM	152	JEREZ2E27G	Applique IP44 E27 Antracite	368
GIADAI120B	GIADA II 320mm Anello decorativo Nero	152	JET33BDC	Spotlight LED IP65 3W 3000K Bianco 24V	408
GIADAI121B	GIADA II 280mm Anello decorativo Nero	152	JET33CDC	Spotlight LED IP65 3W 3000K Corten 24V	408
GLOWA	Testa-palo Solare ricaricabile LED 950lm - 3CCT- IP65 - Batteria Li-ION	470	JET33NDC	Spotlight LED IP65 3W 3000K Nero 24V	408
GLOWAPOLE	Paletto per GLOWA Nero 700mm con picchetto	470	JETBASEN	Base di fissaggio nera per JET	409
GRANADA21B	Applique IP65 1 x GU10 Max 7W Bianco	364	JETPOLEN	Picchetto e 3x30cm di stelo neri per JET	409
GRANADA21C	Applique IP65 1 x GU10 Max 7W Corten	364	JUPITER18PIR	CL1R Plafoniera LED 18W Circolare-3CCT-PIR- Bianco	136
GRANADA21G	Applique IP65 1 x GU10 Max 7W Antracite	364	KALAP4800NK	Testa-palo Solare ricaricabile LED 4800lm - 3CCT- IP65 - Batteria LiFePO4	444
GRANADA22B	Applique IP65 2 x GU10 Max 7W Bianco	365	KALAP48HY	Testa-palo Solare Ibrido ricaricabile LED 4800lm - 3CCT- IP65 - Batteria LiFePO4	438
			KYOTO1002G	Proiettore LED 15000lm - 4000K - grigio - 25°	274
			KYOTO1004G	Proiettore LED 15000lm - 4000K - grigio - 60°	274
			KYOTO1005G	Proiettore LED 15000lm - 4000K - grigio - 120°	274
			KYOTO100AG	Proiettore LED 15000lm - 4000K - grigio - Asimmetrico 50°x120°	274
			KYOTO100NG	Proiettore LED 15000lm - 4000K - grigio - Asimmetrico 26x60°	274
			KYOTO1502G	Proiettore LED 22500lm - 4000K - grigio - 25°	275

CODICE	DESCRIZIONE	PAG	CODICE	DESCRIZIONE	PAG
KYOTO1504G	Proiettore LED 22500lm - 4000K - grigio - 60°	275	LAGOS210B	Applique LED IP54 9W 3CCT Bianco	376
KYOTO1505G	Proiettore LED 22500lm - 4000K - grigio - 120°	275	LAGOS210C	Applique LED IP54 9W 3CCT Corten	376
KYOTO150AG	Proiettore LED 22500lm - 4000K - grigio - Asimmetrico 50°x120°	275	LAGOS210G	Applique LED IP54 9W 3CCT Grigio Antracite	376
KYOTO150NG	Proiettore LED 22500lm - 4000K - grigio - Asimmetrico 26x60°	275	LAGOS2E27B	Applique IP54 E27 Bianco	376
KYOTO2002G	Proiettore LED 30000lm - 4000K - grigio - 25°	276	LAGOS2E27C	Applique IP54 E27 Corten	376
KYOTO2004G	Proiettore LED 30000lm - 4000K - grigio - 60°	276	LAGOS2E27G	Applique IP54 E27 Grigio Antracite	376
KYOTO2005G	Proiettore LED 30000lm - 4000K - grigio - 120°	276	LAGOS2E27M	Applique IP54 E27 Grigio Marina	376
KYOTO200AG	Proiettore LED 30000lm - 4000K - grigio - Asimmetrico 50°x120°	276	LAGOS2E27N	Applique IP54 E27 Nero	376
KYOTO200NG	Proiettore LED 30000lm - 4000K - grigio - Asimmetrico 26x60°	276	LAGOSMODK	Modulo LED Sostitutivo Applique Lagos 9W CCT	235
KYOTO3002G	Proiettore LED 45000lm - 4000K - grigio - 25°	277	LC22K	Circolina LED 14W 1600lm 3CCT con magneti	121
KYOTO3004G	Proiettore LED 45000lm - 4000K - grigio - 60°	277	LC32K	Circolina LED 19W 2200lm 3CCT con magneti	121
KYOTO3005G	Proiettore LED 45000lm - 4000K - grigio - 120°	277	LC40K	Circolina LED 24W 2700lm 3CCT con magneti	121
KYOTO300AG	Proiettore LED 45000lm - 4000K - grigio - Asimmetrico 50°x120°	277	LD0WPF106	WPF1*0.6 Plafoniera Stagna 660mm vuota per 1 tubo a LED	248
KYOTO300NG	Proiettore LED 45000lm - 4000K - grigio - Asimmetrico 26x60°	277	LD0WPF112	WPF1*1.2 Plafoniera Stagna 1265mm vuota per 1 tubo a LED	248
KYOTO5002G	Proiettore LED 77500lm - 4000K - grigio - 25°	278	LD0WPF115	WPF1*1.5 Plafoniera Stagna 1565mm vuota per 1 tubo a LED	248
KYOTO5004G	Proiettore LED 77500lm - 4000K - grigio - 60°	278	LD0WPF206	WPF2*0.6 Plafoniera Stagna 660mm vuota per 2 tubi a LED	248
KYOTO5005G	Proiettore LED 77500lm - 4000K - grigio - 120°	278	LD0WPF212	WPF2*1.2 Plafoniera Stagna 1262mm vuota per 2 tubi a LED	248
KYOTO500AG	Proiettore LED 77500lm - 4000K - grigio - Asimmetrico 50°x120°	278	LD0WPF215	WPF2*1.5 Plafoniera Stagna 1562mm vuota per 2 tubi a LED	248
KYOTO500NG	Proiettore LED 77500lm - 4000K - grigio - Asimmetrico 26x60°	278	LD1STRD15	LED Strip Driver 12V 15Wmax	220
KYOTO-M150	Morsa Palo KYOTO 100/150W Diametro palo 40-90mm	274	LD1STRD30	LED Strip Driver 12V 30Wmax	220
KYOTO-M150	Morsa Palo KYOTO 100/150W Diametro palo 40-90mm	275	LD1STRD60	LED Strip Driver 12V 60Wmax	220
KYOTO-M300	Morsa Palo KYOTO 200/300W Diametro palo 40-150mm	276	LD2PANFRM-2	Cornice Universale Componibile Mont. Soffitto per Panel 600x600mm con Viti	172
KYOTO-M300	Morsa Palo KYOTO 200/300W Diametro palo 40-150mm	277	LD2PANFRM-2B	Cornice Universale Componibile Mont. Soffitto per Panel 300x1200mm con Viti	172
KYOTO-M300	Morsa Palo KYOTO 200/300W Diametro palo 40-150mm	278	LD2SPTA01A	Kit Montaggio per GU10 - Rotondo - Orientabile - Argento Verniciato	190
KYOTO-TP60	Testa Palo 60mm per KYOTO	274	LD2SPTA01B	Kit Montaggio per GU10 - Rotondo - Orientabile - Bianco Verniciato	190
KYOTO-TP60	Testa Palo 60mm per KYOTO	275	LD2SPTA01S	Kit Montaggio per GU10 - Rotondo - Orientabile -Metallo Spazzolato	190
KYOTO-TP60	Testa Palo 60mm per KYOTO	276	LD2SPTA02B	Kit Montaggio per GU10 - Quadrato - Orientabile - Bianco Verniciato	190
KYOTO-TP60	Testa Palo 60mm per KYOTO	277	LD2STRD06	LED Strip Driver 24V 6Wmax	220
KYOTO-TP60	Testa Palo 60mm per KYOTO	278	LD2STRD120	LED Strip Driver 24V 120Wmax	220
L15TG	L-Germicida 15W T8	129	LD2STRD15	LED Strip Driver 24V 15Wmax	220
L30TG	L-Germicida 30W T8	129	LD2STRD30	LED Strip Driver 24V 30Wmax	220
L36TG	L-Germicida 40W T8	129	LD2STRD60	LED Strip Driver 24V 60Wmax	220
L506082AC	Tubo T5 1200lm 549mm 8,0W WW	121	LD2STRD75	LED Strip Driver 24V 75Wmax	220
L506083AC	Tubo T5 1200lm 549mm 8,0W CW	121	LD2WPF183	Plafò Stagna 650mm 18,0W 4000K	249
L509122AC	Tubo T5 1800lm 849mm 12,0W WW	121	LD2WPF183MW	Plafò Stagna 650mm 18,0W 4000K con Sensore a Micro-onde	252
L509123AC	Tubo T5 1800lm 849mm 12,0W CW	121	LD2WPF303	Plafò Stagna 1250mm 30,0W 4000K	249
L512162AC	Tubo T5 2400lm 1149mm 16,0W WW	121	LD2WPF303E	Plafò Stagna 1250mm 30,0W 4000K Emergenza	251
L512163AC	Tubo T5 2400lm 1149mm 16,0W CW	121	LD2WPF303L	Plafò Stagna 1250mm 30,0W 4000K Passante	250
L515202AC	Tubo T5 3000lm 1449mm 20,0W WW	121	LD2WPF303MW	Plafò Stagna 1250mm 30,0W 4000K con Sensore a Micro-onde	252
L515203AC	Tubo T5 3000lm 1449mm 20,0W CW	121	LD2WPF453	Plafò Stagna 1550mm 45,0W 4000K	249
L6TG	L-Germicida 6W T5	129	LD2WPF453E	Plafò Stagna 1550mm 45,0W 4000K Emergenza	251
L8TG	L-Germicida 8W T5	129	LD2WPF453L	Plafò Stagna 1550mm 45,0W 4000K Passante	250
LAGOS110B	Applique LED IP54 9W 3CCT Bianco	374	LD2WPF453MW	Plafò Stagna 1550mm 45,0W 4000K con Sensore a Micro-onde	252
LAGOS110C	Applique LED IP54 9W 3CCT Corten	374	LD2WPF653	Plafò Stagna 1550mm 65,0W 4000K	249
LAGOS110G	Applique LED IP54 9W 3CCT Grigio Antracite	374	LD2WPF653E	Plafò Stagna 1550mm 65,0W 4000K Emergenza	251
LAGOS1E27B	Applique IP54 E27 Bianco	374	LD2WPF653MW	Plafò Stagna 1550mm 65,0W 4000K con Sensore a Micro-onde	252
LAGOS1E27C	Applique IP54 E27 Corten	374	LD2WPF813	Plafò Stagna 1550mm 81,0W 4000K	249
LAGOS1E27G	Applique IP54 E27 Grigio Antracite	374	LD2WPF813E	Plafò Stagna 1550mm 81,0W 4000K Emergenza	251
LAGOS1E27M	Applique IP54 E27 Grigio Marina	374			
LAGOS1E27N	Applique IP54 E27 Nero	374			

CODICE	DESCRIZIONE	PAG	CODICE	DESCRIZIONE	PAG
LD2WPF813MW	Plafò Stagna 1550mm 81,0W 4000K con Sensore a Micro- onde	252	LD4PAN3653B-2D	Backlit Panel 300x1200x34mm 36W CW DALI/PUSH	168
LD3HB150N	High Bay 150W - 4000K - Nero	256	LD4PAN3653U-2	Backlit Panel 600x600x35mm 36W CW UGR<19	166
LD3HB200N	High Bay 200W - 4000K - Nero 100.000h	257	LD4PAN3653U-2D	Backlit Panel 600x600x35mm 36W CW UGR<19 DALI/PUSH	166
LD3PAN3851	Panel 600x600mm 38W DL	169	LD4PAN3653U9-2	Backlit Panel 600x600x35mm 36W CW UGR<19 CRI>90	166
LD3PAN3852	Panel 600x600mm 38W WW	169	LD4PAN3653U9-2D	Backlit Panel 600x600x35mm 36W CW UGR<19 CRI>90 DALI/ PUSH	166
LD3PAN3852U9	Panel 600x600mm 38W WW - UGR<19 HIGH-CRI	169	LD4PAN3653UB9-2	Backlit Panel 300x1200x35mm 36W CW UGR<19 CRI>90	168
LD3PAN3853	Panel 600x600mm 38W CW	169	LD4PA- N3653UB9-2D	Backlit Panel 300x1200x35mm 36W CW UGR<19 CRI>90 DALI/PUSH	168
LD3PAN3853B	Panel 300x1200mm 38W CW	170	LD4PAN3653V-2	Backlit Panel 600x600x30mm 36W CW VALUE PACK x4	167
LD3PAN3853U	Panel 600x600mm 38W CW - UGR<19	169	LD4PAN3653VU-2	Backlit Panel 600x600x31mm 36W CW UGR19 VALUE PACK x4	167
LD3PAN3853U9	Panel 600x600mm 38W CW - UGR<19 HIGH-CRI	169	LD4PAN5053	Backlit Panel 600x600x34mm 36W CW	165
LD3PAN3853UB9	Panel 300x1200mm 40W CW - UGR<19 HIGH-CRI	170	LD4PAN5053D	Backlit Panel 600x600x34mm 36W CW DALI/PUSH	165
LD3PAN4552U	Panel 600x600mm 45W WW - UGR<19	169	LD4PAN5053U	Backlit Panel 600x600x35mm 36W CW UGR<19	165
LD3PAN4553U	Panel 600x600mm 45W CW - UGR<19	169	LD4PAN5053UD	Backlit Panel 600x600x35mm 36W CW UGR<19 DALI/PUSH	165
LD3PAN CAB	Kit Montaggio Sospensione per LED Panel	172	LD4PAN CAB	Kit Montaggio Sospensione per LED BACKLIT Panel	172
LD3PAND38	DRIVER per LED Panel 38W	172	LD4PAND36-2	DRIVER per LED Panel 36W	173
LD3PAND40	DRIVER per LED Panel 40W	172	LD4PANFRM	Cornice Universale Montaggio a Soffitto per Panel 600x600x50mm ad Incastro	172
LD3PAND42D	DRIVER per LED Panel 42W DIM 1-10V	172	LD4PANFRMB	Cornice Universale Montaggio a Soffitto per Panel 300x1200mm ad Incastro	172
LD3PAND45	DRIVER per LED Panel 45W	172	LD4PANFRMH	Cornice Universale Montaggio a Soffitto per Panel 600x600x67mm ad Incastro	172
LD3PANINK	Kit Montaggio Universale ad Incasso per Panel 600x600mm BIANCO RAL9016	172	LD4PANFRMHB	Cornice Universale Montaggio a Soffitto per Panel 300x1200x67mm ad Incastro	172
LD3PANINKB	Kit Montaggio Universale ad Incasso per Panel 300x1200mm BIANCO RAL9016	172	LD4PANSAFE	Kit Cavo sicurezza per LED BACKLIT Panel	172
LD3PANSPG	Kit Montaggio Incasso (molle) per Led Panel	172	LD4SPT063K	Modulo LED diam 50mm - 550lm - 38° - CCT	232
LD3SPTA02A	Kit Montaggio per GU10 - Quadrato - Orientabile - Argento Verniciato	190	LD4SPT063KD	Modulo LED diam 50mm - 550lm - 38° - CCT - DIM	232
LD3SPTA02S	Kit Montaggio per GU10 - Quadrato - Orientabile - Metallo spazzolato	190	LD4SPT065K	Modulo LED diam 50mm - 500lm - 100° - CCT	232
LD3SPTA91B	Kit Montaggio per LED Module - Rotondo - Fisso - Bianco - Waterproof	190	LD4SPT065KD	Modulo LED diam 50mm - 500lm - 100° - CCT - DIM	232
LD3STRD120	LED Strip Driver 48V 120Wmax	220	LD4SPTA01B	Kit Montaggio per GU10 da 1 lampadina - Quadrato - Orientabile - Bianco Verniciato	191
LD3STRD150	LED Strip Driver 48V 150Wmax	220	LD4SPTA01N	Kit Montaggio per GU10 da 1 lampadina - Quadrato - Orientabile - Nero Verniciato	191
LD3STRD75	LED Strip Driver 48V 75Wmax	220	LD4SPTA02B	Kit Montaggio per GU10 da 2 lampadine - Quadrato - Orientabile - Bianco Verniciato	191
LD3WPF183	Plafò Stagna 600mm 18,0W 4000K	253	LD4SPTA02N	Kit Montaggio per GU10 da 2 lampadine - Quadrato - Orientabile - Nero Verniciato	191
LD3WPF361	Plafò Stagna 1200mm 36,0W 6500K	253	LD4SPTA03B	Kit Montaggio per GU10 da 3 lampadine - Quadrato - Orientabile - Bianco Verniciato	191
LD3WPF363	Plafò Stagna 1200mm 36,0W 4000K	253	LD4SPTA03N	Kit Montaggio per GU10 da 3 lampadine - Quadrato - Orientabile - Nero Verniciato	191
LD3WPF521	Plafò Stagna 1500mm 52,0W 6500K	253	LD4SPTB01B	Kit Montaggio per GU10 da 1 lampadina - Rotondo - Orien- tabile - Bianco Verniciato	191
LD3WPF523	Plafò Stagna 1500mm 52,0W 4000K	253	LD4SPTB01N	Kit Montaggio per GU10 da 1 lampadina - Rotondo - Orien- tabile - Nero Verniciato	191
LD4BAR03052	Barra T5 300mm 5,0W 220/240V WarmWhite	239	LD5HB200N5D	High Bay 100/150/200W 4000K Nero 90° DIM 0-10V	259
LD4BAR03053	Barra T5 300mm 5,0W 220/240V CoolWhite	239	LD5HB200NXD	High Bay 100/150/200W 4000K Nero 120° DIM 0-10V	259
LD4BAR06092	Barra T5 572mm 9,0W 220/240V WarmWhite	239	LED13XKIT	Expo 12 Torce Gomma LED con 3xAAA incluse	502
LD4BAR06093	Barra T5 572mm 9,0W 220/240V CoolWhite	239	LED16X	Flashlight torcia portatile a led ricaricabile	496
LD4BAR12182	Barra T5 1178mm 18,0W 220/240V WarmWhite	239	LED21	Boston luce notturna a 5 led 1W - 14lm - 2900K con sensore crepuscolare	507
LD4BAR12183	Barra T5 1178mm 18,0W 220/240V CoolWhite	239	LED23	Luce notturna mod. Denver a 9 led 1,8W - 15lm - 3000K con sensore crepuscolare e di movimento.	507
LD4HB100B	Slim High Bay 100W - 4000K - Bianco	258	LED24	Luce notturna mod. Kansas a led 0,4W - 1,5 lm - 3000K con sensore crepuscolare.	507
LD4HB100G	Slim High Bay 100W - 4000K - Grigio	258	LED26	LED HEAD Light 3 Watt - 200lm - 30.000h - LED CREE	500
LD4HB150G	Slim High Bay 150W - 4000K - Grigio	258	LEDSENS10X2B	Goccia con sensore crepuscolare 1060lm 10,7W WW	114
LD4HB200G	Slim High Bay 200W - 4000K - Grigio	258	LEDSENS10X3B	Goccia con sensore crepuscolare 1060lm 10,7W CW	114
LD4HBKIT	Staffa Montaggio per High Bay Slim	258	LEON12B	Applique LED IP65 Rettangolare 12W CCT Switch Bianco	398
LD4PAN2553H	Backlit Panel 600x600x34mm 25W CW	164	LEON12C	Applique LED IP65 Rettangolare 12W CCT Switch Corten	398
LD4PAN2553HU	Backlit Panel 600x600x34mm 25W UGR<19 CW	164	LEON12FB	Applique LED IP65 Rettangolare 13W CCT Switch Bianco	396
LD4PAN3652-2	Backlit Panel 600x600x34mm 36W WW	166			
LD4PAN3652-2D	Backlit Panel 600x600x34mm 36W WW DALI/PUSH	166			
LD4PAN3652V-2	Backlit Panel 600x600x30mm 36W WW VALUE PACK x4	167			
LD4PAN3653-2	Backlit Panel 600x600x34mm 36W CW	166			
LD4PAN3653-2D	Backlit Panel 600x600x34mm 36W CW DALI/PUSH	166			
LD4PAN3653B-2	Backlit Panel 300x1200x34mm 36W CW	168			

CODICE	DESCRIZIONE	PAG	CODICE	DESCRIZIONE	PAG
LEON12FC	Applique LED IP65 Rettangolare 13W CCT Switch Corten	396	LT15243E.1	Tube 2300lm 1500mm 19,0W CW (Sc.10pz+ST)	119
LEON1E27	Lanterna E27 IP44 Antracite MAX 60W	395	LT15243H	HPTube 3300lm 1500mm 22,0W CW	118
LEON1E27P	Paletto con lanterna E27 IP44 Antracite MAX 60W	394	LT15271H	HPTube 4000lm 1500mm 26,5W DL	118
LEON2E27B	Plafoniera AI+PC 2x E27 IP65 Bianca MAX 20W	400	LT15273H	HPTube 4000lm 1500mm 26,5W CW	118
LEON2E27C	Plafoniera AI+PC 2x E27 IP65 Corten MAX 20W	400	LTSTU2	Starter Universale per tubi LED SHOT	121
LEON2E27G	Plafoniera AI+PC 2x E27 IP65 Antracite MAX 20W	400	LUNA9B	Applique LED IP54 Rotonda 9W CCT Switch Bianco	332
LINDA24KP	Plafoniera slim 283mm 16/20/24W CCT	138	LUNA9G	Applique LED IP54 Rotonda 9W CCT Switch Antracite	332
LINDA32KP	Plafoniera slim 383mm 24/28/32W CCT	138	MADRID24BK	Applique LED IP65 Rettangolare 2x12W CCT Bianco	326
LINDA40KP	Plafoniera slim 483mm 32/36/40W CCT	138	MADRID24CK	Applique LED IP65 Rettangolare 2x12W CCT Corten	326
LINDA48KP	Plafoniera slim 583mm 40/44/48W CCT	138	MADRID24GK	Applique LED IP65 Rettangolare 2x12W CCT Antracite	326
LINDAKITS	Kit sospensione per plafoniere LINDA	138	MADRID7BK	Applique LED IP65 Rettangolare 2x3,5W CCT Bianco	324
LINZB	Spotlight da parete GU10 Bianco	197	MADRID7CK	Applique LED IP65 Rettangolare 2x3,5W CCT Corten	324
LINZC	Spotlight da parete GU10 Corten	197	MADRID7GK	Applique LED IP65 Rettangolare 2x3,5W CCT Antracite	324
LINZN	Spotlight da parete GU10 Nero	197	MAGNETIKAB	Lampada da tavolo ricaricabile Bianca 3W 200LM dim 3000K IP54 1800mAh	316
LR03	Ministilo AAA 1,5V Evolution (BL 4 pz.)	504	MAGNETIKAN	Lampada da tavolo ricaricabile Nera 3W 200LM dim 3000K IP54 1800mAh	316
LR03/10	Ministilo 1,5v Alkaline (Pack 10 pz.)	504	MAGNETIKAS	Lampada da tavolo ricaricabile Silver 3W 200LM dim 3000K IP54 1800mAh	316
LR03/16	Ministilo 1,5v Alkaline (Pack 16 pz.)	504	MAIORCA6B	Applique LED IP54 7W CCT Bianco	370
LR14/2	1/2 Torcia C 1,5V Evolution (BL 2 pz.)	504	MAIORCA6M	Applique LED IP54 7W CCT Grigio Marina	370
LR20/2	Torcia D 1,5V Evolution (BL 2 pz.)	504	MALAGAB	Plafoniera IP65 cilindrica GU10 Max 35W Bianco	342
LR43	Alkaline AG12/186 1,5V (BI 1 pz)	505	MALAGAC	Plafoniera IP65 cilindrica GU10 Max 35W Corten	342
LR44	Alkaline A76 1,5V h.5,41 (BI 1 pz)	505	MALAGAG	Plafoniera IP65 cilindrica GU10 Max 35W Antracite	342
LR54	Alkaline LR1130/189 1,5V (BI 1 pz)	505	MALAGAM	Plafoniera IP65 cilindrica GU10 Max 35W Grigio Marina	342
LR6	Stilo AA 1,5V Evolution (BL 4 pz.)	504	MALAGAN	Plafoniera IP65 cilindrica GU10 Max 35W Nero	342
LR6/10	Stilo 1,5v Alkaline (Pack 10 pz.)	504	MARBELLA10BQK	Applique LED IP65 Quadrata 2x5W CCT Bianco	336
LR6/16	Stilo 1,5v Alkaline (Pack 16 pz.)	504	MARBELLA10BRK	Applique LED IP65 Rotonda 2x5W CCT Bianco	337
LT0605FL	Tube T8 500lm 600mm 5,2W FOOD	120	MARBELLA10CQK	Applique LED IP65 Quadrata 2x5W CCT Corten	336
LT06091E	Tube 900lm 600mm 7,5W DL	119	MARBELLA10CRK	Applique LED IP65 Rotonda 2x5W CCT Corten	337
LT06091H	HPTube 1350lm 600mm 9,0W DL	118	MARBELLA10GQK	Applique LED IP65 Quadrata 2x5W CCT Antracite	336
LT06091SE	Tube 900lm 600mm 9,0W DL	120	MARBELLA10GRK	Applique LED IP65 Rotonda 2x5W CCT Antracite	337
LT06092E	Tube 900lm 600mm 7,5W WW	119	MARBELLA10MQK	Applique LED IP65 Quadrata 2x5W CCT Grigio Marina	336
LT06093E	Tube 900lm 600mm 7,5W CW	119	MARBELLA10NQK	Applique LED IP65 Quadrata 2x5W CCT Nero	336
LT06093E.1	Tube 900lm 600mm 7,5W CW (Sc.10pz+ST)	119	MARBELLA10SUN	Proiettore Solare LED nero 9W- 3CCT- 1400lm IP65 - Batteria Litio 2600mAh	466
LT06093H	HPTube 1350lm 600mm 9,0W CW	118	MARBELLA20BQK	Applique LED IP65 Quadrata 2x10W CCT Bianco	338
LT06093SE	Tube 900lm 600mm 9,0W CW	120	MARBELLA20CQK	Applique LED IP65 Quadrata 2x10W CCT Corten	338
LT0908FL	Tube T8 750lm 900mm 7,9W FOOD	120	MARBELLA20GQK	Applique LED IP65 Quadrata 2x10W CCT Antracite	338
LT09131E	Tube 1200lm 900mm 10,0W DL	119	MARBELLA20MQK	Applique LED IP65 Quadrata 2x10W CCT Grigio Marina	338
LT09133E	Tube 1200lm 900mm 10,0W CW	119	MARBELLA9SUNB	Proiettore Solare LED Marbella Bianco 9W- 4000K - 950lm IP65 - Batteria Litio 2600mAh	468
LT12123H	HPTube 2550lm 1200mm 12,0W CW	118	MARBELLA9SUNB2	Proiettore Solare LED Marbella Bianco 9W- 3000K - 950lm IP65 - Batteria Litio 2600mAh	468
LT1212FL	Tube T8 1100lm 1200mm 11,6W FOOD	120	MARBELLA9SUNC	Proiettore Solare LED Marbella Corten 9W- 4000K - 950lm IP65 - Batteria Litio 2600mAh	468
LT12181E	Tube 1800lm 1200mm 15,0W DL	119	MARBELLA9SUNC2	Proiettore Solare LED Marbella Corten 9W- 3000K - 950lm IP65 - Batteria Litio 2600mAh	468
LT12181H	HPTube 2600lm 1200mm 17,5W DL	118	MARBELLA9SUNG	Proiettore Solare LED Marbella Antracite 9W- 4000K - 950lm IP65 - Batteria Litio 2600mAh	468
LT12181SE	Tube 1800lm 1200mm 17,5W DL	120	MARBELLA9SUNG2	Proiettore Solare LED Marbella Antracite 9W- 3000K - 950lm IP65 - Batteria Litio 2600mAh	468
LT12182E	Tube 1800lm 1200mm 15,0W WW	119	MARBELLADUO-20BK	Applique LED IP65 4x5W CCT Bianco	340
LT12183E	Tube 1800lm 1200mm 15,0W CW	119	MARBELLADUO-20CK	Applique LED IP65 4x5W CCT Corten	340
LT12183E.1	Tube 1800lm 1200mm 15,0W CW (Sc.10pz+ST)	119	MARBELLADUO-20GK	Applique LED IP65 4x5W CCT Antracite	340
LT12183H	HPTube 2600lm 1200mm 17,5W CW	118	MARBELLAPOLEC	Paletto per MARBELLA9SUN Corten 800mm	468
LT12183SE	Tube 1800lm 1200mm 17,5W CW	120	MARBELLAPOLEG	Paletto per MARBELLA9SUN Antracite 800mm	468
LT15173H	HPTube 3600lm 1500mm 17,0W CW	118	MARBELLAPOLEN	Paletto per MARBELLA10SUN Nero 800mm	466
LT1518FL	Tube T8 1700lm 1500mm 17,9W FOOD	120			
LT15221SE	Tube 2300lm 1500mm 22,0W DL	120			
LT15223SE	Tube 2300lm 1500mm 22,0W CW	120			
LT15241E	Tube 2300lm 1500mm 19,0W DL	119			
LT15241H	HPTube 3300lm 1500mm 22,0W DL	118			
LT15242E	Tube 2300lm 1500mm 19,0W WW	119			
LT15243E	Tube 2300lm 1500mm 19,0W CW	119			

CODICE	DESCRIZIONE	PAG	CODICE	DESCRIZIONE	PAG
MARBELLASPIKE	Picchetto per paletto per MARBELLAPOLE	466	MLD4011X3	Globo 125 FULL-LIGHT 1521lm 11,0W E27 CW	71
MARBELLASPIKE	Picchetto per paletto per MARBELLAPOLE	468	MLD4013X2D	Globo 125 FULL-LIGHT 1521lm 11,0W E27 WW DIMM	73
MAYA-B	Lampada da tavolo ricaricabile Bianca 3W 250LM dim 3000K IP54 2x2600mAh	312	MLD4016X2	Globo 125 FULL-LIGHT 2452lm 18,0W E27 WW	71
MAYA-C	Lampada da tavolo ricaricabile Corten 3W 250LM dim 3000K IP54 2x2600mAh	312	MLD4016X3	Globo 125 FULL-LIGHT 2452lm 18,0W E27 CW	71
MAYA-N	Lampada da tavolo ricaricabile Nera 3W 250LM dim 3000K IP54 2x2600mAh	312	MLD4022X2	Globo 125 FULL-LIGHT 3452lm 21,5W E27 WW	71
MERIDA6C	Paletto da giardino IP65 GU10 Corten 60cm	393	MLD4208X2	Globo 95 FULL-LIGHT 806lm 7,0W E27 WW	71
MERIDA6G	Paletto da giardino IP65 GU10 Antracite 60cm	393	MLD4210X2	Globo 95 FULL-LIGHT 1055lm 8,5W E27 WW	71
MFD-1050-42-D	Driver DALI/Push. 700-1050mA, 9-42Vdc	175	MLD4215X2	Globo 95 FULL-LIGHT 1521lm 10,5W E27 WW	71
MFD-600-42-D	Driver DALI/Push. 250-600mA, 14-42V	174	MLD7814X2D	Tubolare T38 FULL-LIGHT 1900lm 14,0W E27 WW DIMM	73
MLD1008X2	Goccia FULL-LIGHT 806lm 7,0W E27 WW	68	MLH1016X2	Goccia FULL-LIGHT 2452lm 13,0W E27 WW	68
MLD1008X2D	Goccia FULL-LIGHT 806lm 7,0W E27 WW DIM	72	MLH1016X3	Goccia FULL-LIGHT 2452lm 13,0W E27 CW	68
MLD1008X3	Goccia FULL-LIGHT 806lm 7,0W E27 CW	68	MOD0632DC	Modulo LED 12-24V diam 50mm - 500lm - 38° - IP65 - 2700K	233
MLD1010X2	Goccia FULL-LIGHT 1055lm 8,5W E27 WW	68	MOD0633DC	Modulo LED 12-24V diam 50mm - 500lm - 38° - IP65 - 3000K	233
MLD1010X3	Goccia FULL-LIGHT 1055lm 8,5W E27 CW	68	MOD0652DC	Modulo LED 12-24V diam 50mm - 600lm - 100° - IP65 - 2700K	233
MLD1011X2	Goccia FULL-LIGHT 1521lm 10,5W E27 WW	68	MOD0653DC	Modulo LED 12-24V diam 50mm - 600lm - 100° - IP65 - 3000K	233
MLD1011X2D	Goccia FULL-LIGHT 1521lm 11,0W E27 WW DIM	72	MODA15K	Modulo LED d120 15W CCT	228
MLD1011X3	Goccia FULL-LIGHT 1521lm 10,5W E27 CW	68	MODA18K	Modulo LED d135 18W CCT	228
MLD1016X2	Goccia FULL-LIGHT 2452lm 18,0W E27 WW	68	MODA24K	Modulo LED d170 24W CCT	228
MLD1016X3	Goccia FULL-LIGHT 2452lm 18,0W E27 CW	68	MOdB202B	Modulo LED d203 20W 3000K	229
MLD1022X2	Goccia FULL-LIGHT 3452lm 22,0W E27 WW	68	MOdB203B	Modulo LED d203 20W 4000K	229
MLD1022X3	Goccia FULL-LIGHT 3452lm 22,0W E27 CW	68	MODC24K	Modulo LED d215 24W CCT	230
MLD2002X2	Oliva Full Light 250lm 2,5W E14 WW	70	MODC34K	Modulo LED d285 34W CCT	230
MLD2004F2	Fiamma FULL-LIGHT 470lm 4,5W E14 WW	70	MOONB	Applique Solare ricaricabile LED Bianca 5,2W- 4000K-1000lm- IP54 - Batteria Litio 2000mAh	480
MLD2004T2	Tortiglione FULL-LIGHT 470lm 4,5W E14 WW	70	MOONB2	Applique Solare ricaricabile LED Bianca 5,2W- 3000K-1000lm- IP54 - Batteria Litio 2000mAh	480
MLD2004X2	Oliva FULL-LIGHT 470lm 4,5W E14 WW	70	MOONN	Applique Solare ricaricabile LED Nera 5,2W- 4000K-1000lm- IP54 - Batteria Litio 2000mAh	480
MLD2004X2D	Oliva FULL-LIGHT 470lm 4,5W E14 WW DIM	72	MOONN2	Applique Solare ricaricabile LED Nera 5,2W- 3000K-1000lm- IP54 - Batteria Litio 2000mAh	480
MLD2004X3	Oliva FULL-LIGHT 470lm 4,5W E14 CW	70	MURCIA1A	Applique IP65 GU10 Max 7W Carta da Zucchero	348
MLD2006F2	Fiamma FULL-LIGHT 806lm 6,5W E14 WW	70	MURCIA1B	Applique IP65 GU10 Max 7W Bianco	348
MLD2006T2	Tortiglione FULL-LIGHT 806lm 6,5W E14 WW	70	MURCIA1C	Applique IP65 GU10 Max 7W Corten	348
MLD2006X2	Oliva FULL-LIGHT 806lm 6,5W E14 WW	70	MURCIA1G	Applique IP65 GU10 Max 7W Antracite	348
MLD2006X2D	Oliva FULL-LIGHT 806lm 5,9W E14 WW DIM	72	MURCIA1T	Applique IP65 GU10 Max 7W Tortora	348
MLD2006X3	Oliva FULL-LIGHT 806lm 6,5W E14 CW	70	MURCIA1V	Applique IP65 GU10 Max 7W Verde Salvia	348
MLD2007X2	Oliva FULL-LIGHT 1055lm 7,0W E14 WW	70	MURCIA2B	Applique IP65 2 x GU10 Max 7W Bianco	350
MLD2007X3	Oliva FULL-LIGHT 1055lm 7,0W E14 CW	70	MURCIA2C	Applique IP65 2 x GU10 Max 7W Corten	350
MLD3002X2	Sfera FULL LIGHT 250lm 2,5W E14 WW	69	MURCIA2G	Applique IP65 2 x GU10 Max 7W Antracite	350
MLD3004X2	Sfera FULL-LIGHT 470lm 4,5W E14 WW	69	NAE70SI	Sodio SUPER 70W Elissoidale E27	126
MLD3004X2D	Sfera FULL-LIGHT 470lm 4,5W E14 WW DIM	72	NAES100	Sodio SUPER 100W Elissoidale E40	126
MLD3004X3	Sfera FULL-LIGHT 470lm 4,5W E14 CW	69	NAES150	Sodio SUPER 150W Elissoidale E40	126
MLD3006X2	Sfera FULL-LIGHT 806lm 6,5W E14 WW	69	NAES70	Sodio SUPER 70W Elissoidale E27	126
MLD3006X2D	Sfera FULL-LIGHT 806lm 5,9W E14 WW DIM	72	NATS100	Sodio SUPER 100W Tubolare E40	126
MLD3006X3	Sfera FULL-LIGHT 806lm 6,5W E14 CW	69	NATS150	Sodio SUPER 150W Tubolare E40	126
MLD3007X2	Sfera FULL-LIGHT 1055lm 7,0W E14 WW	69	NATS250	Sodio SUPER 250W Tubolare E40	126
MLD3007X3	Sfera FULL-LIGHT 1055lm 7,0W E14 CW	69	NATS400	Sodio SUPER 400W Tubolare E40	126
MLD3102X2	Sfera FULL LIGHT 250lm 2,5W E27 WW	69	NIVES112BK	Applique LED IP65 Rettangolare 12W 3CCT Bianco	328
MLD3104X2	Sfera FULL-LIGHT 470lm 4,5W E27 WW	69	NIVES112CK	Applique LED IP65 Rettangolare 12W 3CCT Corten	328
MLD3104X3	Sfera FULL-LIGHT 470lm 4,5W E27 CW	69	NIVES112GK	Applique LED IP65 Rettangolare 12W 3CCT Antracite	328
MLD3106X2	Sfera FULL-LIGHT 806lm 6,5W E27 WW	69	NIVES220BK	Applique LED IP65 Rettangolare 2x10W 3CCT Bianca	330
MLD3106X3	Sfera FULL-LIGHT 806lm 6,5W E27 CW	69	NIVES220CK	Applique LED IP65 Rettangolare 20W 3CCT Corten	330
MLD3107X2	Sfera FULL-LIGHT 1055lm 7,0W E27 WW	69	NIVES220GK	Applique LED IP65 Rettangolare 20W 3CCT Antracite	330
MLD3107X3	Sfera FULL-LIGHT 1055lm 7,0W E27 CW	69	NORA24QK	Plafoniera LED 12/18/24W Quadrata CCT	148
MLD4008X2	Globo 125 FULL-LIGHT 806lm 7,0W E27 WW	71	NORA24RK	Plafoniera LED 12/18/24W Circolare CCT	146
MLD4010X2	Globo 125 FULL-LIGHT 1055lm 8,5W E27 WW	71	NORA36QK	Plafoniera LED 24/30/36W Quadrata CCT	148
MLD4011X2	Globo 125 FULL-LIGHT 1521lm 11,0W E27 WW	71	NORA36RK	Plafoniera LED 24/30/36W Circolare CCT	146

CODICE	DESCRIZIONE	PAG	CODICE	DESCRIZIONE	PAG
NORAMINIL	Applique LED IP65 Quadrata 3Power 3CCT	334	PERG421NDALI	Proiettore da binario 42W - CRI>90 - DALI/PUSH - CCT - Nero - 15°	202
NORAMINIM	Applique LED IP65 Quadrata 3Power 3CCT	334	PERG421NFOOD	Proiettore da binario 36/38/40/42W - Food Meat/Bread - Nero - 15°	203
NORAMINIS	Applique LED IP65 Quadrata 3Power 3CCT	334	PERG422B	Proiettore da binario 36/38/40/42W - CRI>90 - CCT - Bianco - 24°	200
ORLANDO10B	Proiettore LED 10W - 3000K - Bianco	262	PERG422BDALI	Proiettore da binario 42W - CRI>90 - DALI/PUSH - CCT - Bianco - 24°	202
ORLANDO10G	Proiettore LED 10W - 4000K - Grigio	262	PERG422BFOOD	Proiettore da binario 36/38/40/42W - Food Meat/Bread - Bianco - 24°	203
ORLANDO150G	Proiettore LED 150W - 4000K - Grigio	272	PERG422N	Proiettore da binario 36/38/40/42W - CRI>90 - CCT - Nero - 24°	200
ORLANDO200G	Proiettore LED 200W - 4000K - Grigio	273	PERG422NDALI	Proiettore da binario 42W - CRI>90 - DALI/PUSH - CCT - Nero - 24°	202
ORLANDO20B	Proiettore LED 20W - 3000K - Bianco	264	PERG422NFOOD	Proiettore da binario 36/38/40/42W - Food Meat/Bread - Nero - 24°	203
ORLANDO20BN	Proiettore LED 20W - 4000K - Bianco	264	PERG423B	Proiettore da binario 36/38/40/42W - CRI>90 - CCT - Bianco - 36°	200
ORLANDO20G	Proiettore LED 20W - 4000K - Grigio	264	PERG423BDALI	Proiettore da binario 42W - CRI>90 - DALI/PUSH - CCT - Bianco - 36°	202
ORLANDO20GD	Proiettore LED 20W - 6500K - Grigio	264	PERG423BFOOD	Proiettore da binario 36/38/40/42W - Food Meat/Bread - Bianco - 36°	203
ORLANDO20GIR	Proiettore LED 20W - 4000K - Grigio - PIR Sensor	265	PERG423N	Proiettore da binario 36/38/40/42W - CRI>90 - CCT - Nero - 36°	200
ORLANDO30B	Proiettore LED 30W - 3000K - Bianco	266	PERG423NDALI	Proiettore da binario 42W - CRI>90 - DALI/PUSH - CCT - Nero - 36°	202
ORLANDO30BN	Proiettore LED 30W - 4000K - Bianco	266	PERG423NFOOD	Proiettore da binario 36/38/40/42W - Food Meat/Bread - Nero - 36°	203
ORLANDO30G	Proiettore LED 30W - 4000K - Grigio	266	PERG424B	Proiettore da binario 36/38/40/42W - CRI>90 - CCT - Bianco - 60°	200
ORLANDO30GD	Proiettore LED 30W - 6500K - Grigio	266	PERG424BDALI	Proiettore da binario 42W - CRI>90 - DALI/PUSH - CCT - Bianco - 60°	202
ORLANDO30GIR	Proiettore LED 30W - 4000K - Grigio - PIR Sensor	267	PERG424BFOOD	Proiettore da binario 36/38/40/42W - Food Meat/Bread - Bianco - 60°	203
ORLANDO50B	Proiettore LED 50W - 3000K - Bianco	268	PERG424N	Proiettore da binario 36/38/40/42W - CRI>90 - CCT - Nero - 60°	200
ORLANDO50BN	Proiettore LED 50W - 4000K - Bianco	268	PERG424NDALI	Proiettore da binario 42W - CRI>90 - DALI/PUSH - CCT - Nero - 60°	202
ORLANDO50G	Proiettore LED 50W - 4000K - Grigio	268	PERG424NFOOD	Proiettore da binario 36/38/40/42W - Food Meat/Bread - Nero - 60°	203
ORLANDO50GD	Proiettore LED 50W - 6500K - Grigio	268	PP05CM	P.Pera CH 1/2C(13W) E14 220V-240V	125
ORLANDO50GIR	Proiettore LED 50W - 4000K - Grigio - PIR Sensor	269	PP15MFF240	P.Pera x Forno CH 15W E14 220V-240V 300 °C	125
ORLANDO90B	Proiettore LED 90W - 3000K - Bianco	270	PP25MFF	P.Pera x Forni CH 25W E14 220V-240V 300 °C	125
ORLANDO90BN	Proiettore LED 90W - 4000K - Bianco	270	R80WT60RTW	R80 WiFi+BLE Tuya 806lm 8,5W E27 RGB+CCT DIM	39
ORLANDO90G	Proiettore LED 90W - 4000K - Grigio	270	R1150	R127 150W Infrarossi RED E27	124
ORLANDO90GD	Proiettore LED 90W - 6500K - Grigio	270	R1250	R127 250W Infrarossi RED E27	124
OSLO01A	Cornice ARGENTO per UNIPANEL Circolare	180	RONDA20BK	Applique LED IP65 Rotonda 20W 3CCT Bianco	154
OSLO01N	Cornice NERO per UNIPANEL Circolare	180	RONDA20CK	Applique LED IP65 Rotonda 20W 3CCT Corten	154
OSLO01R	Cornice ROSA per UNIPANEL Circolare	180	RONDA20GK	Applique LED IP65 Rotonda 20W 3CCT Grigio Antracite	154
OSLO02A	Cornice ARGENTO per UNIPANEL Quadrato	182	RONDA30BK	Applique LED IP65 Rotonda 30W 3CCT Bianco	155
OSLO02N	Cornice NERA per UNIPANEL Quadrato	182	RONDA30CK	Applique LED IP65 Rotonda 30W 3CCT Corten	155
OSLO02R	Cornice ROSA per UNIPANEL Quadrato	182	RONDA30GK	Applique LED IP65 Rotonda 30W 3CCT Grigio Antracite	155
OSLO11A	Cornice ARGENTO per BIG OSLO Circolare	181	SAN-B	Lampada da tavolo ricaricabile Bianca 0,8W 80LM dim 3000K 500mAh	306
OSLO11N	Cornice NERO per BIG OSLO Circolare	181	SAN-N	Lampada da tavolo ricaricabile Nera 0,8W 80LM dim 3000K 500mAh	306
OSLO11R	Cornice ROSA per BIG OSLO Circolare	181	SEGOVIA110B	Applique LED IP54 10W 4000K Bianco	372
OSLO185XC	UNIPANEL 18W 1600lm CCT Circolare	180	SEGOVIA110C	Applique LED IP54 10W 4000K Corten	372
OSLO185XQ	UNIPANEL 18W 1600lm CCT Quadrato	182	SEGOVIA110G	Applique LED IP54 10W 4000K Antracite	372
OSLO285XC	BIG OSLO 28W 2500lm CCT Circolare	181	SEGOVIA1E27B	Applique IP54 E27 Bianco	372
OVIEDO150	BH1R Bulkhead LED 15W OVALE - CCT - Bianco/Nero IP65	159	SEGOVIA1E27C	Applique IP54 E27 Corten	372
OVIEDO15OPIR	BH1R Bulkhead LED 15W OVALE - CCT - Bianco/Nero IP65 - con sensore PIR	159	SEGOVIA1E27G	Applique IP54 E27 Antracite	372
OVIEDO15OS	BH1R Bulkhead LED 15W OVALE - CCT - Bianco/Nero IP65 con sensore crepuscolare	159	SEGOVIA1E27M	Applique IP54 E27 Grigio Marina	372
OVIEDO15R	BH1R Bulkhead LED 15W Circolare - CCT - Bianco/Nero IP65	158	SEGOVIAMOD2	Modulo LED Sostitutivo Applique Segovia 10W 3000K	234
OVIEDO15RS	BH1R Bulkhead LED 15W Circolare - CCT - Bianco/Nero IP65 con sensore crepuscolare	158	SEGOVIAMOD3	Modulo LED Sostitutivo Applique Segovia 10W 4000K	234
OVIEDO180	BH1R Bulkhead LED 18W OVALE - CCT - Bianco/Nero IP65	159			
OVIEDO24R	BH1R Bulkhead LED 24W Circolare - CCT - Bianco/Nero IP65	158			
P45WT40RTW	P45 WiFi Tuya 470lm 4,9W E14 RGB+CCT DIM	38			
PERG421B	Proiettore da binario 36/38/40/42W - CRI>90 - CCT - Bianco - 15°	200			
PERG421BDALI	Proiettore da binario 42W - CRI>90 - DALI/PUSH - CCT - Bianco - 15°	202			
PERG421BFOOD	Proiettore da binario 36/38/40/42W - Food Meat/Bread - Bianco - 15°	203			
PERG421N	Proiettore da binario 36/38/40/42W - CRI>90 - CCT - Nero - 15°	200			

CODICE	DESCRIZIONE	PAG	CODICE	DESCRIZIONE	PAG
SLD1009X2D	Goccia 806lm 8,4W E27 OP WW DIM	88	SLD620442HT	GU10 All-Glass 500lm 4,0W 60° WW - High Temp	98
SLD1009X2DC	Goccia 806lm 8,0W E27 OP WW - AC/DC 12/24V	114	SLD620443HT	GU10 All-Glass 500lm 4,0W 60° CW - High Temp	98
SLD1009X2DC2	Goccia 1055lm 8,5W E27 OP WW - AC/DC 12/24V	114	SLD620451HT	GU10 All-Glass 500lm 4,0W 120° DL - High Temp	98
SLD1009X3DC	Goccia 806lm 8,0W E27 OP CW - AC/DC 12/24V	114	SLD620452HT	GU10 All-Glass 500lm 4,0W 120° WW - High Temp	98
SLD1011X2M	Goccia 1060lm 9,5W E27 OP WW Sensore Movimento e Sensore Crepuscolare	114	SLD620453HT	GU10 All-Glass 500lm 4,0W 120° CW - High Temp	98
SLD1011X2SP	Goccia 1055lm 9,5W E27 OP WW Surge Protection	116	SLD620512	GU10 All-Glass 450lm 5,0W 15° WW	99
SLD1011X3SP	Goccia 1055lm 9,5W E27 OP CW Surge Protection	116	SLD620513	GU10 All-Glass 450lm 5,0W 15° CW	99
SLD1014X2D	Goccia 1521lm 13,6W E27 OP WW DIM	88	SLD620532	GU10 All-Glass 410lm 4,0W 36° WW	99
SLD1014X3D	Goccia 1521lm 13,6W E27 OP CW DIM	88	SLD620532BD	GU10 All-Glass 345lm 3,6W 36° WW DIM	99
SLD1021X2D	Goccia 2452lm 18W E27 OP WW DIM	88	SLD620532D	GU10 All-Glass 345lm 3,6W 36° WW DIM	99
SLD1021X3D	Goccia 2452lm 21,0W E27 OP CW DIM	88	SLD620732	GU10 All-Glass 535lm 5,5W 36° WW	99
SLD2006X2D	Oliiva 470lm 4,9 W E14 OP WW DIM	88	SLD620732BD	GU10 All-Glass 535lm 5,5W 36° WW DIM	99
SLD3006X2D	Sfera 470lm 4,5W E14 OP WW DIM	88	SLD620732D	GU10 All-Glass 535lm 5,5W 36° WW DIM	99
SLD4115X1B	Globo 120 1521lm 13,5W E27 DL	87	SLD620742	GU10 All-Glass 535lm 5,5W 60° WW	99
SLD4115X2B	Globo 120 1521lm 13,5W E27 WW	87	SLD620752	GU10 All-Glass 500lm 5,5W 110° WW	99
SLD4115X3B	Globo 120 1521lm 13,5W E27 CW	87	SLD630531B	GU10 345lm 4,2W 36° DL	96
SLD4121X1B	Globo 120 1900lm 16,0W E27 DL	87	SLD630532B	GU10 345lm 4,2W 36° WW	96
SLD4121X2B	Globo 120 1900lm 16,0W E27 WW	87	SLD630533B	GU10 345lm 4,2W 36° CW	96
SLD4121X2BB	Globo 120 1900lm 16,0W E27 WW	87	SLD630541B	GU10 345lm 4,2W 60° DL	96
SLD4121X3B	Globo 120 1900lm 16,0W E27 CW	87	SLD630542B	GU10 345lm 4,2W 60° WW	96
SLD4122X1B	Globo 120 2452lm 20,0W E27 DL	87	SLD630543B	GU10 345lm 4,2W 60° CW	96
SLD4122X2B	Globo 120 2452lm 20,0W E27 WW	87	SLD630731B	GU10 535lm 4,9W 36° DL	96
SLD4122X3B	Globo 120 2452lm 20,0W E27 CW	87	SLD630732B	GU10 535lm 4,9W 36° V WW	96
SLD4210X1B	Globo 95 1055lm 9,5W E27 DL	87	SLD630732BB	GU10 535lm 4,9W 36° WW	96
SLD4210X2B	Globo 95 1055lm 9,5W E27 WW	87	SLD630733B	GU10 535lm 4,9W 36° CW	96
SLD4210X3B	Globo 95 1055lm 9,5W E27 CW	87	SLD630741B	GU10 500lm 4,9W 60° DL	96
SLD4215X1B	Globo 95 1521lm 13,5W E27 DL	87	SLD630742B	GU10 500lm 4,9W 60° VWW	96
SLD4215X2B	Globo 95 1521lm 13,5W E27 WW	87	SLD630742BB	GU10 500lm 4,9W 60° WW	96
SLD4215X3B	Globo 95 1521lm 13,5W E27 CW	87	SLD630743B	GU10 500lm 4,9W 60° CW	96
SLD500351B	Reflector R39 250lm 3,0W E14 120° DL	92	SLD630751B	GU10 535lm 4,9W 110° DL	97
SLD500352B	Reflector R39 250lm 2,5W E14 120° WW	92	SLD630752B	GU10 535lm 4,9W 110° WW	97
SLD500353B	Reflector R39 250lm 3,0W E14 120° CW	92	SLD630752BB	GU10 535lm 4,9W 110° WW	97
SLD500551B	Reflector R50 470lm 4,9W E14 120° DL	92	SLD630753B	GU10 535lm 4,9W 110° CW	97
SLD500552B	Reflector R50 470lm 4,9W E14 120° WW	92	SLD630842D	GU10 500lm 5,7W 60° WW DIM	97
SLD500552BB	Reflector R50 470lm 4,9W E14 120° WW	92	SLD630843D	GU10 580lm 5,7W 60° CW DIM	97
SLD500553B	Reflector R50 470lm 4,9W E14 120° CW	92	SLD630951B	GU10 670lm 7,1W 100° DL	97
SLD500951B	Reflector R63 806lm 8,0W E27 120° DL	93	SLD630952B	GU10 670lm 7,1W 100° VWW	97
SLD500952B	Reflector R63 806lm 8,0W E27 120° WW	93	SLD630952BB	GU10 670lm 7,1W 100° WW	97
SLD500952BB	Reflector R63 806lm 8,0W E27 120° WW	93	SLD630953B	GU10 670lm 7,1W 100° CW	97
SLD500953B	Reflector R63 806lm 8,0W E27 120° CW	93	SLD631031B	GU10 1000lm 7,0W 36° DL	95
SLD501251B	Reflector R80 1055lm 9,5W E27 120° DL	93	SLD631032B	GU10 1000lm 7,0W 36° WW	95
SLD501252B	Reflector R80 1055lm 9,5W E27 120° WW	93	SLD631032BB	GU10 1000lm 7,0W 36° WW	95
SLD501253B	Reflector R80 1055lm 9,5W E27 120° CW	93	SLD631033B	GU10 1000lm 7,0W 36° CW	95
SLD551022D	PAR30 800lm 9,5W 40° WW IP65 DIM	102	SLD631051B	GU10 1000lm 7,0W 100° DL	95
SLD551023D	PAR30 800lm 9,5W 40° CW IP65 DIM	102	SLD631052B	GU10 1000lm 7,0W 100° WW	95
SLD561622D	PAR38 1400lm 16W 40° WW IP65 DIM	102	SLD631052BB	GU10 1000lm 7,0W 100° WW	95
SLD561623D	PAR38 1400lm 16W 40° CW IP65 DIM	102	SLD631052BBD	GU10 900lm 6,5W 100° WW DIM	97
SLD5713329	AR111 950lm G53 13,0W 12V AC/DC 40° WW CRI>97 DIM	109	SLD631053B	GU10 1000lm 7,0W 100° CW	95
SLD5713339	AR111 950lm G53 13,0W 12V AC/DC 40° CW CRI>97 DIM	109	SLD631053BD	GU10 950lm 6,5W 100° CW DIM	97
SLD620431HT	GU10 All-Glass 500lm 4,0W 36° DL - High Temp	98	SLD650741B	MR16 520lm 6,9W 12V 60° DL	100
SLD620432HT	GU10 All-Glass 500lm 4,0W 36° WW - High Temp	98	SLD650742B	MR16 560lm 6,9W 12V 60° WW	100
SLD620433HT	GU10 All-Glass 500lm 4,0W 36° CW - High Temp	98	SLD650743B	MR16 560lm 6,9W 12V 60° CW	100
SLD620441HT	GU10 All-Glass 500lm 4,0W 60° DL - High Temp	98	SLD660332	MR-11 200lm 2,3W 12V 36° WW	100
			SLD670642	MR16 All-Glass 500lm 6,2W 60° WW	101
			SLD670642D	MR16 All-Glass 360lm 4,9W 12V 60° WW DIM	101

<b>CODICE</b>	<b>DESCRIZIONE</b>	<b>PAG</b>	<b>CODICE</b>	<b>DESCRIZIONE</b>	<b>PAG</b>
SLD7102X1FRB	P.Pera Frigo 150lm 1,3W E14 DL	89	SLD9105X2	Lineare 300lm 300mm 5W 2 attacchi S14s	110
SLD7102X2B	P.Pera 150lm 1,3W E14 WW	89	SLD9108X2	Lineare 700lm 500mm 7,5W- 2 attacchi S14s	110
SLD7102X2DC	P.Pera 24V WW	90	SLD9114X2	Lineare 1055lm 1000mm 11W 2 attacchi S14s	110
SLD7202XB	P.Pera 1,5W E14 Blu	90	SLD9508X2D	Lineare 1055lm 8,2W 118mm R7s WW DIM	106
SLD7202XG	P.Pera 1,5W E14 Verde	90	SLD9511X2	Lineare 1521lm 10,7W 118mm R7s WW	106
SLD7202XR	P.Pera 1,5W E14 Rosso	90	SLD9511X3	Lineare 1521lm 10,7W 118mm R7s CW	106
SLD7308X1	Tubolare T37 806lm 7,0W E14 DL	91	SLD9610X2	Lineare 1055lm 8,2W 78 mm R7s	107
SLD7308X2	Tubolare T37 806lm 7,0W E14 WW	91	SLD9716X2D	Lineare 2000lm 15,5W 118 mm R7s - WW - DIM	107
SLD7308X3	Tubolare T37 806lm 7,0W E14 CW	91	SLD9716X3D	Lineare 2000lm 15,5W 118 mm R7s - CW - DIM	107
SLD7309X1	Tubolare T37 1055lm 8,0W E14 DL	91	SLD9730X2	Lineare 3000lm 18,0W 118 mm R7s - WW	107
SLD7309X2	Tubolare T37 1055lm 8,0W E14 WW	91	SLD9730X3	Lineare 3000lm 18,0W 118 mm R7s - CW	107
SLD7309X3	Tubolare T37 1055lm 8,0W E14 CW	91	SLD9840X2	HID 4000lm 24,0W WW E27	111
SLD7408X1	Tubolare T37 806lm 7,0W E27 DL	91	SLD9840X2W	HID 3200lm 30,0W VWW E27	111
SLD7408X2	Tubolare T37 806lm 7,0W E27 WW	91	SLD9840X3	HID 4000lm 28,0W CW E27	111
SLD7408X3	Tubolare T37 806lm 7,0W E27 CW	91	SLD9845X2	HID-T 4500lm 28,0W WW E27	112
SLD7410X1	Tubolare T45 1055lm 9,5W E27 DL	91	SLD9845X3	HID-T 4500lm 28,0W CW E27	112
SLD7410X2	Tubolare T45 1055lm 9,5W E27 WW	91	SLD9850X1	HID 5000lm 36,0W DL E27	111
SLD7410X3	Tubolare T45 1055lm 9,5W E27 CW	91	SLD9850X2	HID 5000lm 36,0W WW E27	111
SLD7414X1	Tubolare T45 1521lm 12,0W E27 DL	91	SLD9850X2E40	HID 5000lm 34,0W WW E40	111
SLD7414X2	Tubolare T45 1521lm 12,0W E27 WW	91	SLD9850X2W	HID 4200lm 36,0W VWW E27	111
SLD7414X3	Tubolare T45 1521lm 12,0W E27 CW	91	SLD9850X3	HID 5000lm 34,0W CW E27	111
SLD751052	ALC 1000lm 11,5W G24d WW	108	SLD9850X3E40	HID 5000lm 34,0W CW E40	111
SLD751053	ALC 1000lm 11,5W G24d CW	108	SLD9875X2E40	HID-T 7200lm 38,0W WW E40	112
SLD760552	AL 460lm 5,7W G23 WW	108	SLD9875X3E40	HID-T 7500lm 38,0W CW E40	112
SLD760553	AL 510lm 5,7W G23 CW	108	SLD9975X3	HID 7600lm 52,0W CW E27	111
SLD760752	AL 670lm 7,2W G23 WW	108	SLD9975X3E40	HID 7600lm 52,0W CW E40	111
SLD760753	AL 720lm 7,2W G23 CW	108	SLH620532	GU10 All-Glass 750lm 4,7W 36° WW	98
SLD770853	AL 1000lm 8,0W 2G11 CW	108	SLH620533	GU10 All-Glass 850lm 4,7W 36° CW	98
SLD771253	AL 1500lm 12,0W 2G11 CW	108	SLH620552	GU10 All-Glass 850lm 4,7W 100° WW	98
SLD771753	AL 2100lm 16,5W 2G11 CW	108	SLH620553	GU10 All-Glass 850lm 4,7W 100° CW	98
SLD772453	AL 3400lm 24,0W 2G11 CW	108	SLH630231	GU10 360lm 2,0W 36° DL	94
SLD8202X2	G4 180lm 1,5W 12V AC/DC WW FR	103	SLH630232	GU10 350lm 2,2W 36° WW	94
SLD8202X3	G4 180lm 1,5W 12V AC/DC CW FR	103	SLH630233	GU10 360lm 2,0W 36° CW	94
SLD8505X2	G9 500lm 4,5W WW	104	SLH630551	GU10 850lm 4,7W 100° DL	94
SLD8505X2D	G9 400lm 4,0W WW DIM	105	SLH630552	GU10 850lm 4,7W 100° WW	94
SLD8505X3	G9 500lm 4,5W CW	104	SLH630553	GU10 850lm 4,7W 100° CW	94
SLD8507X2	G9 700lm 7,0W WW	104	SMM1008XK	Goccia 806lm 9,0W E27 OP CCT	117
SLD8507X3	G9 700lm 7,0W CW	104	SMM63055K	GU10 700lm 7,0W 110° CCT	117
SLD8601X2	G4 110lm 1,0W WW	103	SMM7408XK	Tubolare T37 806lm 8,0W E27 CCT	117
SLD8601X3	G4 110lm 1,0W CW	103	SONJA1E27B	Plafoniera Ovale 290mm IP65 1xE27 220/240V Bianca	157
SLD8603X2	G4 250lm 2,5W WW	103	SONJA1E27N	Plafoniera Ovale 290mm IP65 1xE27 220/240V Nera	157
SLD8603X3	G4 250lm 2,5W CW	103	SONJA3E27B	Plafoniera tonda 350mm IP65 3xE27 220/240V Bianca	156
SLD8702X2S	G9 Full-Glass 250lm 2,2W WW FROST	104	SONJAE27B	Plafoniera tonda 300mm IP65 2xE27 220/240V Bianca	156
SLD8702X3S	G9 Full-Glass 250lm 2,2W CW FROST	104	SONJAE27N	Plafoniera tonda 300mm IP65 2xE27 220/240V Nera	156
SLD8704X2S	G9 Full-Glass 470lm 4,2W WW FROST	104	SORIA4	Segnapasso in ABS+PC 4W tutta luce grigio/bianco 3CCT	430
SLD8704X3S	G9 Full-Glass 470lm 4,2W CW FROST	104	SORIA4A	Segnapasso in ABS+PC 4W asimmetrico grigio/bianco 3CCT	430
SLD8804X2	G9 470lm COB 3,8W WW	105	SORIA4Q	Segnapasso in ABS+PC 4W tutta luce grigio/bianco 3CCT quadrato	431
SLD8804X3	G9 470lm COB 3,8W CW	105	SPIKY1	Picchetto IP65 1 xGU10 30cm cavo incluso - Antracite - con connettore IP68	402
SLD8902X2	G4 180lm 1,8W 12V AC/DC WW	103	SPIKY1B	Picchetto IP65 1 xGU10 30cm cavo incluso - Bianco - con connettore IP68	402
SLD8902X3	G4 180lm 1,8W 12V AC/DC CW	103	SPIKY1C	Picchetto IP65 1 xGU10 30cm cavo incluso - Corten - con connettore IP68	402
SLD8903X2	G4 280lm 2,4W 12V AC/DC WW	103	SPIKY1V	Picchetto IP65 1 xGU10 30cm cavo incluso - Verde - con connettore IP68	402
SLD8903X3	G4 280lm 2,4W 12V AC/DC CW	103			
SLD9005X2	Lineare 450lm 300mm 5W S14d	110			
SLD9008X2	Lineare 700lm 500mm 7,5W attacco S14d	110			

CODICE	DESCRIZIONE	PAG	CODICE	DESCRIZIONE	PAG
SPIKY2	Picchetto IP65 1 xGU10 30cm cavo incluso - Antracite - con connettore IP68	403	STPC201N	Caps per profilo STP201 - Nero - 10 pezzi	222
SPIKY3LC	Picchetto IP65 1 xGU10 50cm cavo incluso - Corten- con connettore IP68	404	STPC202B	Caps per profilo STP202 - Bianco - 10 pezzi	223
SPIKY3LN	Picchetto IP65 1 xGU10 50cm cavo incluso - Nero- con connettore IP68	404	STPC301B	Caps per profilo STP301 - Bianco - 10 pezzi	223
SPIKY3LV	Picchetto IP65 1 xGU10 50cm cavo incluso - Verde - con connettore IP68	404	STPC401B	Caps per profilo STP401 - Bianco - 10 pezzi	223
SPIQO1B	Picchetto quadrato LED IP65 7W 3000K Bianco	406	STR240592220	LED Strip 5m 5,1W/m 24V 922 IP20	212
SPIQO1C	Picchetto quadrato LED IP65 7W 3000K Corten	406	STR240592720	LED Strip 5m 5,1W/m 24V 927 IP20	212
SPIQO1N	Picchetto quadrato LED IP65 7W 3000K Nero	406	STR240592754	LED Strip 5m 5,1W/m 24V 927 IP54	214
SPIQO1V	Picchetto quadrato LED IP65 7W 3000K Verde	406	STR240593020	LED Strip 5m 5,1W/m 24V 930 IP20	212
STC241092120	LED Strip COB 5m 10,0 W/m 24V 921 IP20	217	STR240593054	LED Strip 5m 5,1W/m 24V 930 IP54	214
STC241092720	LED Strip COB 5m 10,0 W/m 24V 927 IP20	217	STR240594020	LED Strip 5m 5,1W/m 24V 940 IP20	212
STC241093020	LED Strip COB 5m 10,0 W/m 24V 930 IP20	217	STR240594054	LED Strip 5m 5,1W/m 24V 940 IP54	214
STC241094020	LED Strip COB 5m 10,0 W/m 24V 940 IP20	217	STR240596520	LED Strip 5m 5,1W/m 24V 965 IP20	212
STC241096020	LED Strip COB 5m 10,0 W/m 24V 960 IP20	217	STR240596554	LED Strip 5m 5,1W/m 24V 965 IP54	214
STC2410BLU20	LED Strip COB 5m 10,0W/m 24V BLU IP20	211	STR241092220	LED Strip 5m 10,5W/m 24V 922 IP20	212
STC2410GRN20	LED Strip COB 5m 10,0W/m 24V VERDE IP20	211	STR241092720	LED Strip 5m 10,5W/m 24V 927 IP20	212
STC2410PNK20	LED Strip COB 5m 10,0W/m 24V ROSA IP20	211	STR241092754	LED Strip 5m 10,5W/m 24V 927 IP54	214
STC2410RED20	LED Strip COB 5m 10,0W/m 24V ROSSO IP20	211	STR241093020	LED Strip 5m 10,5W/m 24V 930 IP20	212
STC2410VLT20	LED Strip COB 5m 10,0W/m 24V VIOLA IP20	211	STR241093054	LED Strip 5m 10,5W/m 24V 930 IP54	214
STC2410YLW20	LED Strip COB 5m 10,0W/m 24V GIALLO IP20	211	STR241094020	LED Strip 5m 10,5W/m 24V 940 IP20	212
STC2412CCT20	LED Strip COB 5m 12,0 W/m 24V CCT IP20	216	STR241094054	LED Strip 5m 10,5W/m 24V 940 IP54	214
STC481592720	LED Strip COB 5m 15,0 W/m 48V 927 IP20	218	STR241096520	LED Strip 5m 10,5W/m 24V 965 IP20	212
STC481592720-10	LED Strip COB 10m 15,0 W/m 48V 927 IP20	218	STR241096554	LED Strip 5m 10,5W/m 24V 965 IP54	214
STC481593020	LED Strip COB 5m 15,0 W/m 48V 930 IP20	218	STR241592720	LED Strip 5m 15,5W/m 24V 927 IP20	212
STC481593020-10	LED Strip COB 10m 15,0 W/m 48V 930 IP20	218	STR241592720-210	LED Strip 5m 12W/m 24V 927 IP20 - HD	210
STC481593065	LED Strip COB 5m 15,0 W/m 48V 930 IP65	219	STR241592754	LED Strip 5m 14,5W/m 24V 927 IP54	213
STC481593065-10	LED Strip COB 10m 15,0 W/m 48V 930 IP65	219	STR241592767	LED Strip 5m 15,5W/m 24V 927 IP67	215
STC481594020	LED Strip COB 5m 15,0 W/m 48V 940 IP20	218	STR241593020	LED Strip 5m 15,5W/m 24V 930 IP20	212
STC481594020-10	LED Strip COB 10m 15,0 W/m 48V 940 IP20	218	STR241593020-210	LED Strip 5m 12W/m 24V 930 IP20 - HD	210
STC481594065	LED Strip COB 5m 15,0 W/m 48V 940 IP65	219	STR241593054	LED Strip 5m 14,5W/m 24V 930 IP54	213
STC481594065-10	LED Strip COB 10m 15,0 W/m 48V 940 IP65	219	STR241593067	LED Strip 5m 15,5W/m 24V 930 IP67	215
STC481596020	LED Strip COB 5m 15,0 W/m 48V 960 IP20	218	STR241594020	LED Strip 5m 15,5W/m 24V 940 IP20	212
STC481596020-10	LED Strip COB 10m 15,0 W/m 48V 960 IP20	218	STR241594020-210	LED Strip 5m 12W/m 24V 940 IP20 - HD	210
STC481596065	LED Strip COB 5m 15,0 W/m 48V 960 IP65	219	STR241594054	LED Strip 5m 14,5W/m 24V 940 IP54	213
STCCA21	Cavetto di alimentazione per LED Strip - 2 cavi - 8mm	224	STR241594067	LED Strip 5m 15,5W/m 24V 940 IP67	215
STCCA22	Cavetto di alimentazione per LED Strip - 2 cavi - 10mm	224	STR241596520	LED Strip 5m 15,5W/m 24V 965 IP20	212
STCCA3	Cavetto di alimentazione per LED Strip - 3 cavi - 10mm	224	STR241596520-210	LED Strip 5m 12W/m 24V 965 IP20 - HD	210
STCCON1	Controller per LED Strip - Dip Switch	216	STR241596554	LED Strip 5m 14,5W/m 24V 965 IP54	213
STCCON1	Controller per LED Strip - Dip Switch	224	STR241596567	LED Strip 5m 15,5W/m 24V 965 IP67	215
STCCON2	Controller per LED Strip - Tuya Wi-Fi	216	STR242092720	LED Strip 5m 17,0W/m 24V 927 IP20	212
STCCON2	Controller per LED Strip - Tuya Wi-Fi	224	STR242092754	LED Strip 5m 17,5W/m 24V 927 IP54	213
STP101A	Profilo slim in alluminio per LED Strip - Argento 2m	222	STR242092767	LED Strip 5m 17,0W/m 24V 927 IP67	215
STP101B	Profilo slim in alluminio per LED Strip - Bianco 2m	222	STR242093020	LED Strip 5m 17,0W/m 24V 930 IP20	212
STP101N	Profilo slim in alluminio per LED Strip - Nero 2m	222	STR242093020-240	LED Strip 5m 20,0W/m 24V 930 IP20 - HD	210
STP102A	Dissipatore in alluminio per LED Strip - Argento 2m	222	STR242093054	LED Strip 5m 17,5W/m 24V 930 IP54	213
STP201A	Profilo da incasso in alluminio per LED Strip - Argento 2m	222	STR242093067	LED Strip 5m 17,0W/m 24V 930 IP67	215
STP201B	Profilo da incasso in alluminio per LED Strip - Bianco 2m	222	STR242094020	LED Strip 5m 17,0W/m 24V 940 IP20	212
STP201N	Profilo da incasso in alluminio per LED Strip - Nero 2m	222	STR242094020-240	LED Strip 5m 20,0W/m 24V 940 IP20 - HD	210
STP202A	Profilo da incasso in alluminio per LED Strip - Argento 2m	223	STR242094054	LED Strip 5m 17,5W/m 24V 940 IP54	213
STP301A	Profilo angolare in alluminio per LED Strip - Argento 2m	223	STR242094067	LED Strip 5m 17,0W/m 24V 940 IP67	215
STP401A	Profilo per cartongesso in alluminio per LED Strip - Argento 2m	223	STR242096520	LED Strip 5m 17,0W/m 24V 965 IP20	212
STPC101B	Caps per profilo STP101 - Bianco - 10 pezzi (5 testa e 5 coda)	222	STR242096554	LED Strip 5m 17,5W/m 24V 965 IP54	213
STPC101N	Caps per profilo STP101 - Nero - 10 pezzi	222	STR242096567	LED Strip 5m 17,0W/m 24V 965 IP67	215
STPC201B	Caps per profilo STP201 - Bianco - 10 pezzi	222	STRCA20	Connettore per striscia STR IP20 - 5 pezzi	224
			STRCA54	Connettore per striscia STR IP54 - 5 pezzi	224

CODICE	DESCRIZIONE	PAG	CODICE	DESCRIZIONE	PAG
STRCA67	Connettore per striscia STR IP67 - 5 pezzi	224	VIGO4E27C	Applique IP54 E27 Corten mono-emissione	385
TAG-A	Lampada da tavolo ricaricabile Carta da Zuccheri 3W 250LM dim 3000K IP54 2000mAh	314	VIGO4E27G	Applique IP54 E27 Antracite mono-emissione	385
TAG-B	Lampada da tavolo ricaricabile Bianca 3W 250LM dim 3000K IP54 2000mAh	314	WELS40B	Proiettore da binario 30/34/40W UGR<13 CRI>92 fascio reg. Bianco	198
TAG-C	Lampada da tavolo ricaricabile Corten 3W 250LM dim 3000K IP54 2000mAh	314	WELS40N	Proiettore da binario 30/34/40W UGR<13 CRI>92 fascio reg. Nero	198
TAGCB	Base di ricarica per lampada da tavolo ricaricabile TAG	314	WLD1004X2	Goccia Stick 470lm 4,5W E27 WW	53
TAG-I	Lampada da tavolo ricaricabile Avorio 3W 250LM dim 3000K IP54 2000mAh	314	WLD1008X1	Goccia Stick 806lm 7,0W E27 DL	53
TAG-N	Lampada da tavolo ricaricabile Nero 3W 250LM dim 3000K IP54 2000mAh	314	WLD1008X2	Goccia Stick 806lm 7,0W E27 WW	53
TAG-P	Lampada da tavolo ricaricabile Blu Petrolio 3W 250LM dim 3000K IP54 2000mAh	314	WLD1008X29	Goccia Stick 806lm 7,5W E27 WW - CRI > 95	49
TAG-R	Lampada da tavolo ricaricabile Rosso Lampone 3W 250LM dim 3000K IP54 2000mAh	314	WLD1008X2BB	Goccia Stick 806lm 7,0W E27 WW	53
TAG-V	Lampada da tavolo ricaricabile Verde Salvia 3W 250LM dim 3000K IP54 2000mAh	314	WLD1008X2CA	Goccia Stick 680lm 7,0W E27 WW CUPOLA ARG.	65
TIZIA-B	Lampada da Tavolo ricaricabile Blu 2,6W- 3000K-500lm IP54 - Batteria 2000mAh	318	WLD1008X2D	Goccia Stick 806lm 7,0W E27 WW DIM	50
TIZIA-N	Lampada da Tavolo ricaricabile Nera 2,6W- 3000K-500lm IP54 - Batteria 2000mAh	318	WLD1008X2G	Goccia Stick 725lm 7,0W E27 GOLD	76
TIZIA-R	Lampada da Tavolo ricaricabile Rossa 2,6W- 3000K-500lm IP54 - Batteria 2000mAh	318	WLD1008X2S	Goccia Stick 806lm 7,0W E27 WW FR	61
TIZIA-V	Lampada da Tavolo ricaricabile Verde 2,6W- 3000K-500lm IP54 - Batteria 2000mAh	318	WLD1008X3	Goccia Stick 806lm 7,0W E27 CW	53
TIZIA-W	Lampada da Tavolo ricaricabile Bianca 2,6W- 3000K-500lm IP54 - Batteria 2000mAh	318	WLD1008X3D	Goccia Stick 806lm 7,0W E27 CW DIM	50
TOLEDO10BK	Applique LED IP65 2x5W CCT Bianco	346	WLD1008X3S	Goccia Stick 806lm 7,0W E27 CW FR	61
TOLEDO10CK	Applique LED IP65 2x5W CCT Corten	346	WLD1010X1	Goccia Stick 1055lm 8,5W E27 DL	53
TOLEDO10GK	Applique LED IP65 2x5W CCT Antracite	346	WLD1010X2	Goccia Stick 1055lm 8,5W E27 WW	53
TOLEDO1B	Applique IP65 GU10 Max 7W Bianco	344	WLD1010X29	Goccia Stick 1055lm 8,0W E27 WW - CRI > 95	49
TOLEDO1C	Applique IP65 GU10 Max 7W Corten	344	WLD1010X2BB	Goccia Stick 1055lm 8,5W E27 WW	53
TOLEDO1G	Applique IP65 GU10 Max 7W Antracite	344	WLD1010X2D	Goccia Stick 1055lm 9,0W E27 WW DIM	50
TOLEDO1M	Applique IP65 GU10 Max 7W Grigio Marina	344	WLD1010X2S	Goccia Stick 1055lm 8,5W E27 WW FR	61
TOLEDO1N	Applique IP65 GU10 Max 7W Nero	344	WLD1010X3	Goccia Stick 1055lm 8,5W E27 CW	53
TOLEDO2B	Applique IP65 2 x GU10 Max 7W Bianco	345	WLD1010X3D	Goccia Stick 1055lm 9,0W E27 CW DIM	50
TOLEDO2C	Applique IP65 2 x GU10 Max 7W Corten	345	WLD1010X3S	Goccia Stick 1055lm 8,5W E27 CW FR	61
TOLEDO2G	Applique IP65 2 x GU10 Max 7W Antracite	345	WLD1011X1	Goccia Stick 1521lm 10,5W E27 DL	53
TOLEDO2M	Applique IP65 2 x GU10 Max 7W Grigio Marina	345	WLD1011X2	Goccia Stick 1521lm 10,0W E27 WW	53
TOLEDO2N	Applique IP65 2 x GU10 Max 7W Nero	345	WLD1011X29	Goccia Stick 1521lm 11,0W E27 WW - CRI > 95	49
VAASA185KP	UNIDISK 18W 2100lm CCT + PWR	134	WLD1011X2BB	Goccia Stick 1521lm 10,5W E27 WW	53
VAASA185KPS	UNIDISK 18W 2100lm CCT + PWR + SENS	134	WLD1011X2D	Goccia Stick 1521lm 11,0W E27 WW DIM	50
VAASA245KP	UNIDISK 24W 2900lm CCT + PWR	135	WLD1011X3	Goccia Stick 1521lm 10,5W E27 CW	53
VALENCIA2E27B	Applique IP54 E27 biemissione Bianca	380	WLD1011X3D	Goccia Stick 1521lm 11,0W E27 CW DIM	50
VALENCIA2E27C	Applique IP54 E27 biemissione Corten	380	WLD1016X1	Goccia Stick 2452lm 18,0W E27 DL	53
VALENCIA2E27G	Applique IP54 E27 biemissione Antracite	380	WLD1016X2	Goccia Stick 2452lm 18,0W E27 WW	53
VALENCIAE27B	Applique IP54 E27 Bianca	378	WLD1016X3	Goccia Stick 2452lm 18,0W E27 CW	53
VALENCIAE27C	Applique IP54 E27 Corten	378	WLD2002T2	Tortiglione Stick 250lm 2,5W E14 WW	55
VALENCIAE27G	Applique IP54 E27 Antracite	378	WLD2002T2S	Tortiglione Stick 250lm 2,5W E14 WW FR	62
VALENCIAE27N	Applique IP54 E27 Nera	378	WLD2002X2	Oliva Stick 250lm 2,5W E14 WW	55
VIGO1E27B	Applique IP54 E27 Bianco bi-emissione	382	WLD2002X2BB	Oliva Stick 250lm 2,5W E14 WW	55
VIGO1E27C	Applique IP54 E27 Corten bi-emissione	382	WLD2002X2S	Oliva Stick 250lm 2,5W E14 WW FR	62
VIGO1E27G	Applique IP54 E27 Antracite bi-emissione	382	WLD2002X3	Oliva Stick 250lm 2,5W E14 CW	55
VIGO2E27B	Applique IP54 E27 Bianco con griglia	383	WLD2004F2	Fiamma Stick 470lm 4,5W E14 WW	56
VIGO2E27C	Applique IP54 E27 Corten con griglia	383	WLD2004F2S	Fiamma Stick 470lm 4,5W E14 WW FR	63
VIGO2E27G	Applique IP54 E27 Antracite con griglia	383	WLD2004F3	Fiamma Stick 470lm 4,5W E14 CW	56
VIGO3E27B	Applique IP54 E27 Bianco	384	WLD2004F3S	Fiamma Stick 470lm 4,5W E14 CW FR	63
VIGO3E27C	Applique IP54 E27 Corten	384	WLD2004T2	Tortiglione Stick 470lm 4,5W E14 WW	55
VIGO3E27G	Applique IP54 E27 Antracite	384	WLD2004T2G	Tortiglione Stick 420lm 4,5W E14 GOLD	77
VIGO4E27B	Applique IP54 E27 Bianco mono-emissione	385	WLD2004T2S	Tortiglione Stick 470lm 4,5W E14 WW FR	62
			WLD2004T3	Tortiglione Stick 470lm 4,5W E14 CW	55
			WLD2004T3S	Tortiglione Stick 470lm 4,5W E14 CW FR	62
			WLD2004X1	Oliva Stick 470lm 4,5W E14 DL	55
			WLD2004X2	Oliva Stick 470lm 4,5W E14 WW	55
			WLD2004X29	Oliva Stick 470lm 5,0W E14 WW - CRI > 95	49
			WLD2004X2BB	Oliva Stick 470lm 4,5W E14 WW	55

CODICE	DESCRIZIONE	PAG	CODICE	DESCRIZIONE	PAG
WLD2004X2D	Oliva Stick 470lm 4,5W E14 WW - DIM	51	WLD3107X3	Sfera Stick 1055lm 7,0W E27 CW	54
WLD2004X2G	Oliva Stick 420lm 4,5W E14 GOLD	76	WLD4002X2	Globo 125 Stick 250lm 2,5W E27 WW	57
WLD2004X2S	Oliva Stick 470lm 4,5W E14 WW FR	62	WLD4002X2D	Globo 125 Stick 250lm 2,5W E27 WW DIM	52
WLD2004X2SD	Oliva Stick 470lm 4,5W E14 WW - FR - DIM	51	WLD4004X2	Globo 125 Stick 470lm 4,5W E27 WW	57
WLD2004X3	Oliva Stick 470lm 4,5W E14 CW	55	WLD4005X2HSD	Globo 125 Stick 400lm 5,0W E27 WW DIM	52
WLD2004X3D	Oliva Stick 470lm 4,5W E14 CW - DIM	51	WLD4005X2HSDW	Globo 125 Stick 300lm 5,0W E27 VWW DIM	52
WLD2004X3S	Oliva Stick 470lm 4,5W E14 CW FR	62	WLD4008X2	Globo 125 Stick 806lm 7,0W E27 WW	57
WLD2006F2S	Fiamma Stick 806lm 6,5W E14 WW FR	63	WLD4008X2D	Globo 125 Stick 806lm 7,0W E27 WW DIM	52
WLD2006F3S	Fiamma Stick 806lm 6,5W E14 CW FR	63	WLD4008X2G	Globo 125 Stick 725lm 7,0W E27 GOLD	77
WLD2006T2S	Tortiglione Stick 806lm 6,5W E14 WW FR	62	WLD4008X3D	Globo 125 Stick 806lm 7,0W E27 CW DIM	52
WLD2006T3S	Tortiglione Stick 806lm 6,5W E14 CW FR	62	WLD4010X2	Globo 125 Stick 1055lm 8,5W E27 WW	57
WLD2006X2	Oliva Stick 806lm 6,5W E14 WW	55	WLD4010X2S	Globo 125 Stick 1055lm 8,5W E27 WW FR	63
WLD2006X2BB	Oliva Stick 806lm 6,5W E14 WW	55	WLD4010X3	Globo 125 Stick 1055lm 8,5W E27 CW	57
WLD2006X2D	Oliva Stick 806lm 5,9W E14 WW DIM	51	WLD4011X2	Globo 125 Stick 1521lm 11,0W E27 WW	57
WLD2006X2S	Oliva Stick 806lm 6,5W E14 WW FR	62	WLD4011X3	Globo 125 Stick 1521lm 11,0W E27 CW	57
WLD2006X3	Oliva Stick 806lm 6,5W E14 CW	55	WLD4013X2D	Globo 125 Stick 1521lm 11,0W E27 WW DIMM	52
WLD2006X3S	Oliva Stick 806lm 6,5W E14 CW FR	62	WLD4013X3D	Globo 125 Stick 1521lm 11,0W E27 CW DIMM	52
WLD2007X2	Oliva Stick 1055lm 7,0W E14 WW	55	WLD4208X2	Globo 95 Stick 806lm 7,0W E27 WW	57
WLD2007X2BB	Oliva Stick 1055lm 7,0W E14 WW	55	WLD4208X2G	Globo 95 Stick 725lm 7,0W E27 GOLD	77
WLD2007X3	Oliva Stick 1055lm 7,0W E14 CW	55	WLD4210X2	Globo 95 Stick 1055lm 8,5W E27 WW	57
WLD3001X2	Sfera Stick 136lm 1,4W E14 WW	54	WLD4210X3	Globo 95 Stick 1055lm 8,5W E27 CW	57
WLD3002X2	Sfera Stick 250lm 2,5W E14 WW	54	WLD4215X2	Globo 95 Stick 1521lm 10,5W E27 WW	57
WLD3002X2S	Sfera Stick 250lm 2,5W E14 WW FR	61	WLD500252	R39 Stick 125lm 2,5W E14 110° WW	63
WLD3004X1	Sfera Stick 470lm 4,5W E14 DL	54	WLD500452	R50 Stick 330lm 4,5W E14 110° WW	64
WLD3004X2	Sfera Stick 470lm 4,5W E14 WW	54	WLD500652	R80 Stick 470lm 4,5W E27 80° WW	64
WLD3004X29	Sfera Stick 470lm 5,0W E14 WW - CRI > 95	49	WLD500752	R63 Stick 806lm 7,0W E27 110° WW	64
WLD3004X2BB	Sfera Stick 470lm 4,5W E14 WW	54	WLD500852	R80 Stick 806lm 7,0W E27 80° WW	64
WLD3004X2D	Sfera Stick 470lm 4,5W E14 WW DIMM	50	WLD501152D	R125 Stick 1055lm 11,0W E27 WW DIM	65
WLD3004X2S	Sfera Stick 470lm 4,5W E14 WW FR	61	WLD6008X2AM	Globo F.O.B. Stick 500lm 8,0W E27 AM	78
WLD3004X3	Sfera Stick 470lm 4,5W E14 CW	54	WLD6108X2AM	Goccia F.O.B. Stick 500lm 8,0W E27 AM	78
WLD3004X3D	Sfera Stick 470lm 4,5W E14 CW DIM	50	WLD6208X2AM	BT F.O.B. Stick 500lm 8,0W E27 AM	78
WLD3004X3S	Sfera Stick 470lm 4,5W E14 CW FR	61	WLD6308X2AM	Alveare F.O.B. Stick 500lm 8,0W E27 AM	79
WLD3005X2CA	Sfera Stick 400lm 4,5W E14 WW CUPOLA ARG.	65	WLD6408X2AM	Ufo F.O.B. Stick 500lm 8,0W E27 AM	79
WLD3006X2	Sfera Stick 806lm 6,5W E14 WW	54	WLD6508X2AM	Lanterna F.O.B. Stick 500lm 8,0W E27 AM	79
WLD3006X2BB	Sfera Stick 806lm 6,5W E14 WW	54	WLD6508X2SK	Lanterna F.O.B. Stick 250lm 8,0W E27 SK	79
WLD3006X2D	Sfera Stick 806lm 5,9W E14 WW DIM	50	WLD7102X2	P.Pera Stick 250lm 2,5W E14 WW	58
WLD3006X3	Sfera Stick 806lm 6,5W E14 CW	54	WLD7204X2	Tubolare T20 Stick 470lm 4,5W E14 WW	58
WLD3007X2	Sfera Stick 1055lm 7,0W E14 WW	54	WLD7204X3	Tubolare T20 Stick 470lm 4,5W E14 CW	58
WLD3007X2BB	Sfera Stick 1055lm 7,0W E14 WW	54	WLD7301X1	P.Pera Stick 140lm 1.5W E14 DL	58
WLD3007X3	Sfera Stick 1055lm 7,0W E14 CW	54	WLD7301X2	P.Pera Stick 140lm 1.5W E14 WW	58
WLD3101X2	Sfera Stick 136lm 1,4W E27 WW	54	WLD7301X3	P.Pera Stick 140lm 1.5W E14 CW	58
WLD3102X2	Sfera Stick 250lm 2,5W E27 WW	54	WLD7508X2G	Edison Stick 725lm 7,0W E27 GOLD	76
WLD3104X1	Sfera Stick 470lm 4,5W E27 DL	54	WLD7604X2	Tubolare T25 Stick 470lm 4,5W E14 WW	59
WLD3104X2	Sfera Stick 470lm 4,5W E27 WW	54	WLD7604X3	Tubolare T25 Stick 470lm 4,5W E14 CW	59
WLD3104X29	Sfera Stick 470lm 4,9W E27 WW - CRI > 95	49	WLD7606X2	Tubolare T25 Stick 806lm 6,5W E14 WW	59
WLD3104X2BB	Sfera Stick 470lm 4,5W E27 WW	54	WLD7606X3	Tubolare T25 Stick 806lm 6,5W E14 CW	59
WLD3104X2S	Sfera Stick 470lm 4,5W E27 WW FR	61	WLD7708X2BB	Tubolare T32 Stick 1055lm 8,5W E27 WW	59
WLD3104X3	Sfera Stick 470lm 4,5W E27 CW	54	WLD7708X3	Tubolare T32 Stick 1055lm 8,5W E27 CW	59
WLD3106X2	Sfera Stick 806lm 6,5W E27 WW	54	WLD7814X2BBBD	Tubolare T38 Stick 2350lm 14,0W E27 WW DIMM	52
WLD3106X2BB	Sfera Stick 806lm 6,5W E27 WW	54	WLDSENS10X2	Go Stick Sens .Crepuscolare 1055lm 7,8W E27 WW	66
WLD3106X2D	Sfera Stick 806lm 6,0W E27 WW DIMM	50	WLH1008X2	A60 Stick 806lm 3,8W E27 WW	42
WLD3106X3	Sfera Stick 806lm 6,5W E27 CW	54	WLH1008X3	A60 Stick 806lm 3,8W E27 CW	42
WLD3106X3D	Sfera Stick 806lm 6,5W E27 CW DIMM	50	WLH1010X2	A60 Stick 1055lm 5,0W E27 WW	42
WLD3107X2	Sfera Stick 1055lm 7,0W E27 WW	54	WLH1010X3	A60 Stick 1055lm 5,0W E27 CW	42
WLD3107X2BB	Sfera Stick 1055lm 7,0W E27 WW	54	WLH1015X2	A70 Stick 1521lm 7,2W E27 WW	42

CODICE	DESCRIZIONE	PAG	CODICE	DESCRIZIONE	PAG
WLH1015X2B	A60 Stick 1521lm 7,2W E27 WW	42	YUCCAP	Paletto Solare ricaricabile LED Nero 1,8W- 4000K-350lm-IP54 - Batteria Lifio 2000mAh	484
WLH1015X3B	A60 Stick 1521lm 7,2W E27 CW	42	YUMA10NK	Proiettore Solare ricaricabile LED 10W- 3CCT-1100lm IP65 - Batteria Lifio	447
WLH2004X2	Oliva Stick 470lm 2,2W E14 WW	43	YUMA11NK	Proiettore Solare ricaricabile LED 10W- 3CCT-1500lm IP65 - Batteria LiFePO4	452
WLH2004X3	Oliva Stick 470lm 2,2W E14 CW	43	YUMA1200P	Palo da giardino Solare ricaricabile LED 7,5W- 4000K-1200lm IP65 - Batteria LiFePO4 8000mAh	474
WLH2008X2	Oliva Stick 806lm 3,8W E14 WW	43	YUMA1500NK	Proiettore Solare ricaricabile LED 10W- CCT-1500lm IP65 - Batteria Lifio	448
WLH2008X3	Oliva Stick 806lm 3,8W E14 CW	43	YUMA20NK	Proiettore Solare ricaricabile LED 20W- 3CCT-3000lm IP65 - Doppio Fascio - Batteria LiFePO4	454
WLH3004X2	Sfera Stick 470lm 2,2W E14 WW	42	YUMA2800NK	Proiettore Solare ricaricabile LED 20W- CCT-2800lm IP65 - Batteria Lifio	449
WLH3004X3	Sfera Stick 470lm 2,2W E14 CW	42	YUMA2N	Proiettore Solare ricaricabile LED 2W- 4000K-240lm IP65 - Batteria Lifio	464
WLH3008X2	Sfera Stick 806lm 3,8W E14 WW	42	YUMA350P	Palo da giardino Solare ricaricabile LED 2,8W- 3000K-4000K-350lm IP65 - Batteria LiFePO4 6000mAh	472
WLH3008X3	Sfera Stick 806lm 3,8W E14 CW	42	YUMA40NK	Proiettore Solare ricaricabile LED 40W- 3CCT-6600lm IP65 - Doppio Fascio - Batteria LiFePO4	456
WLH4015X2	G125 Stick 1521lm 7,2W E27 WW	43	YUMA4800NK	Proiettore Solare ricaricabile LED 30W- CCT-4800lm IP65 - Batteria Lifio	450
WLH4015X3	G125 Stick 1521lm 7,2W E27 CW	43	YUMA63HY	Proiettore Solare Ibrido LED 40W- 3CCT-6300lm IP65 - Batteria LiFePO4	440
WLW1008X2BB	Goccia White Stick 806lm 7,0W E27 WW	45	YUMA6NK	Proiettore Solare ricaricabile LED 6W- 3CCT-600lm IP65 - Batteria Lifio	446
WLW1008X3	Goccia White Stick 806lm 7,0W E27 CW	45	YUMA8NP	Picchetto Solare ricaricabile LED 8W- 4000K-850lm IP54 - Batteria Lifio	465
WLW1010X2BB	Goccia White Stick 1055lm 8,5W E27 WW	45	YUMASPIKE	Picchetto per YUMA350P e YUMA1200P	472
WLW1010X3	Goccia White Stick 1055lm 8,5W E27 CW	45	YUMASPIKE	Picchetto per YUMA350P e YUMA1200P	474
WLW1015X2BB	Goccia White Stick 1521lm 10,5W E27 WW	45	ZURIGOB	Pendant cilindrico GU10 Bianco	195
WLW1015X3	Goccia White Stick 1521lm 10,5W E27 CW	45	ZURIGOC	Pendant cilindrico GU10 Corten	195
WLW2002X2BB	Oliva White Stick 250lm 2,5W E14 WW	46	ZURIGON	Pendant cilindrico GU10 Nero	195
WLW2002X3	Oliva White Stick 250lm 2,5W E14 CW	46			
WLW2004X2BB	Oliva White Stick 470lm 4,5W E14 WW	46			
WLW2004X3	Oliva White Stick 470lm 4,5W E14 CW	46			
WLW2008X2BB	Oliva White Stick 806lm 6,5W E14 WW	46			
WLW2008X3	Oliva White Stick 806lm 6,5W E14 CW	46			
WLW3004X2BB	Sfera White Stick 470lm 4,5W E14 WW	45			
WLW3004X3	Sfera White Stick 470lm 4,5W E14 CW	45			
WLW4002X2BB	Globo White Stick 250lm 2,5W E27 WW	46			
WLW4002X3	Globo White Stick 250lm 2,5W E27 CW	46			
WLW4015X2BB	Globo White Stick 1521lm 10,5W E27 WW	46			
WLW4015X3	Globo White Stick 1521lm 10,5W E27 CW	46			
WORK10SUN	WORK LIGHT Portatile 10W - CCT - IP54 - Ricaricabile	492			
WORK20E	WORK LIGHT Portatile 20W - 4000K - IP54 - Ricaricabile	493			
WORK50	WORK LIGHT 50W - 4000K - 5500LM - IP54 + 2 prese Schuko	490			
WORK-M	TORCIA DA LAVORO	497			
YGB150R	S-FLAT 300mm ricaricabile 150LM CCT3 dim	244			
YGB210R	S-FLAT 600mm ricaricabile 300LM CCT3 dim	244			
YGB300Q	S-SQUARED 200x200mm ricaricabile 400LM CCT3 dim	244			
YQQ05KB	Q-FLAT 300mm 5,0W CCT3	241			
YQQ09KB	Q-FLAT 572mm 9,0W CCT3	241			
YQQ14KB	Q-FLAT 880mm 14,0W CCT3	241			
YQQ18KB	Q-FLAT 1178mm 18,0W CCT3	241			
YQQ22KB	Q-FLAT 1478mm 22,0W CCT3	241			
YGR04K	S-FLAT Orientabile 300mm 4,0W CCT3	242			
YGR08K	S-FLAT Orientabile 545mm 8,0W CCT3	242			
YGS05KB	S-FLAT 300mm 5,0W CCT3	240			
YGS09KB	S-FLAT 572mm 9,0W CCT3	240			
YGS14KB	S-FLAT 880mm 14,0W CCT3	240			
YGS18KB	S-FLAT 1178mm 18,0W CCT3	240			
YGS22KB	S-FLAT 1478mm 22,0W CCT3	240			
YUCCA	Lanterna Solare ricaricabile LED Nera 1,8W- 4000K-350lm-IP54 - Batteria Lifio 2000mAh	482			
YUCCABULB	Lampada Stick per YUCCA 600lm 5V E27 CW	482			
YUCCABULB	Lampada Stick per YUCCA 600lm 5V E27 CW	484			
YUCCABULB2	Lampada Stick per YUCCA 600lm 5V E27 WW	482			
YUCCABULB2	Lampada Stick per YUCCA 600lm 5V E27 WW	484			







# BOT LIGHTING

FOR A BRIGHT FUTURE



Scansione  
per visitare il sito

BOT LIGHTING S.r.l.  
Via Lombardia 37/39  
30030 Cazzago di Pianiga  
Venezia - Italy  
T. +39 041 51 29 411

[www.botlighting.it](http://www.botlighting.it)  
[info@botlighting.it](mailto:info@botlighting.it)  
[ordini@botlighting.it](mailto:ordini@botlighting.it)



**METEL** BTL